

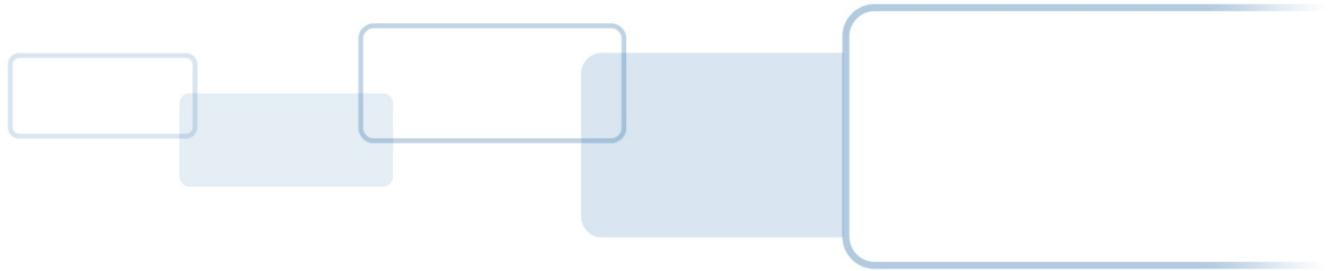

15370 Barranca Parkway  
Irvine, CA 92618



**FARGO<sup>®</sup>**  
**DTC1250e/DTC1000Me/DTC4250e Card Printer**

**USER GUIDE**

PLT-01668, 1.0

October 2013

© 2013 HID Global Corporation/ASSA ABLOY AB. All rights reserved.

## Liability Statement

Do not attempt to operate or repair the Direct-to-Card Printer without adequate training. Any use, operation, or repair in violation of this User Guide is at your own risk. You assume all liability reasonable to your use or misuse of the Direct-to-Card Printer. HID Global Corporation assumes no liability whatsoever for damages of any kind, including without limitation incidental, special or consequential damages. The Direct-to-Card Printer specifications, applications and options are subject to change at the discretion of HID Global Corporation without notice.

## Trademarks

HID GLOBAL, HID, the HID logo, DTC and FARGO are the trademarks or registered trademarks of HID Global Corporation or its licensors in the U.S. and other countries.

## Trademark Acknowledgments

Other trademarks and trade names may be used in this document to refer to either entities claiming the marks and names or their products.

## Revision History

The revision number for this document will be updated to reflect changes, corrections, updates and enhancements to this document.

Revision Control Number	Date	Document Title
Revision 1.0	October 2013	DTC1250e/DTC1000Me/DTC4250e Card Printer User Guide

**Contacts****North America**

15370 Barranca Parkway  
Irvine, CA 92618  
USA

Phone: 800 237 7769

Fax: 949 732 2120

Tech Support: 866 607 7339, #6, M-F 7am-6pm CST

**Europe, Middle East and Africa**

Phoenix Road  
Haverhill, Suffolk CB9 7AE  
England

Phone: +44 1440 714 850

Fax: +44 1440 714 840

Tech Support: +44 1440 711 822 M-F 9am – 5pm GMT

**Asia Pacific**

19/F 625 King's Road  
North Point, Island East  
Hong Kong

Phone: 852 3160 9800

Fax: 852 3160 4809

Tech Support 852 3160 4895 M-F 9am – 6pm GMT +8

**Brazil**

Av Guido Caloi 1985 Prédio 18  
São Paulo – SP  
CEP : 05802-140

Phone: 55 11 5514-7100

Fax: 55 11 5514-7109

Tech Support: 55 11 5514-7110 M-F 9am – 6pm ATC

[support.hidglobal.com](http://support.hidglobal.com)

# Contents

<b>1</b>	<b>Specifications</b> .....	<b>6</b>
1.1	Regulatory Compliance.....	6
1.1.1	Agency Listings.....	6
1.1.2	United States .....	6
1.1.3	Canada .....	7
1.1.4	Taiwan .....	7
1.1.5	Japan.....	7
1.1.6	Korea.....	7
1.2	Safety Messages (Review Carefully).....	8
1.2.1	Safety Messages - Taiwan.....	9
1.2.2	Safety Messages - China.....	10
1.3	Technical Specifications .....	11
1.4	Functional Specifications .....	13
1.4.1	Printer Components: Print Ribbons .....	13
1.4.2	Printer Components: Blank Cards .....	14
<b>2</b>	<b>Setup and Installation Procedures</b> .....	<b>15</b>
2.1	Choosing a Good Location .....	15
2.1.1	About Moisture Condensation.....	15
2.2	Unpacking and Inspection .....	15
2.2.1	Installing the Print Ribbon Cartridge .....	16
2.2.2	Installing Blank Cards into the Input Card Hopper .....	18
2.2.3	Setting the Card Size for CR-79 and CR-80 .....	20
2.2.4	Connecting the Printer power .....	24
<b>3</b>	<b>Print Driver Installation</b> .....	<b>25</b>
3.1	Driver Installation Instructions.....	25
3.1.1	Swift ID Installation Instructions .....	26
3.1.2	Installing Swift ID .....	27
3.1.3	Printer Connected Via USB Connection .....	28
<b>4</b>	<b>Printer Preferences</b> .....	<b>30</b>
4.1	Card .....	30
4.1.1	Card Size .....	30
4.1.2	Orientation .....	31
4.1.3	Copies.....	31
4.2	Diagnostics .....	31
4.3	Test Print.....	31
4.4	Toolbox .....	31
4.4.1	Configuration .....	31
4.4.2	Calibrate Ribbon .....	33
4.4.3	Clean Printer.....	34
4.4.4	Advanced Settings.....	41
4.5	Device Options.....	45
4.5.1	Supplies.....	46

4.5.2	Dual Sided .....	46
4.5.3	Options .....	46
4.6	Image Color .....	47
4.7	Image Calibrate.....	50
4.8	Magnetic Encoding .....	51
4.9	Overlay / Print Area.....	57
4.10	K Panel Resin .....	62
4.10.1	Print All Black with K Panel.....	62
4.10.2	Print YMC under K.....	62
4.10.3	Print K Only.....	63
4.11	Printer Info .....	63
<b>5</b>	<b>System Overview - Troubleshooting .....</b>	<b>64</b>
5.1	Sequence of Operations .....	64
5.2	Troubleshooting .....	65
5.2.1	Printer Error Button and Display Message Table.....	65
5.2.2	Error Message Table .....	66
5.2.3	Troubleshooting with the Error Message Table .....	67
5.2.4	Printer-Specific Tools (DTC1250E, DTC4250E).....	71
<b>6</b>	<b>Firmware Upgrades .....</b>	<b>74</b>
6.1	Upgrade the Printer Firmware .....	74
<b>7</b>	<b>Technical Support.....</b>	<b>76</b>
7.1	Reading the Serial Numbers on a FARGO Printer .....	76
<b>8</b>	<b>Appendix A .....</b>	<b>77</b>
8.1	Selecting the Fluorescent Panel Ribbon Type (DTC4250e only).....	77
8.1.1	Creating a Custom Fluorescent Image using the YMCFKO Ribbon .....	78
8.1.2	Configuring Fluorescent Data using the Application .....	78

# 1 Specifications

The purpose of this section is to provide you with specific information on the Regulatory Compliances, Agency Listings, Technical Specifications and Functional Specifications for the DTC1250e/DTC1000Me/DTC4250e Card Printer User Guide.

## 1.1 Regulatory Compliance

<b>UL</b>	The Card Printer is listed under UL 60950-1 (2 <sup>nd</sup> edition) Information Technology Equipment <b>File Number:</b> E145118 <b>Note:</b> This product is intended to be supplied by a Listed Power Unit marked Class 2 and rated for 24 V dc, 3.3A minimum.
<b>CSA</b>	The Printer manufacturer has been authorized by UL to represent the Card Printer as CSA Certified under CSA Standard C22.2 No. 60950-1-07 2 <sup>nd</sup> edition <b>File Number:</b> E145118
<b>FCC</b>	The Card Printer complies with the requirements in Part 15 of the FCC rules for a Class A digital device.
<b>CE</b>	The Card Printer has been tested and complies with EN300-330-1, EN300-330-2, EN301-489-1, EN301-489-3, EN55022 class A, EN55024, EN6100-3-2, EN6100-3-3, EN60950-1. <b>Note:</b> Based on the above testing, the Printer manufacturer certifies that the Card Printer complies with the following European Council Directives and has placed the CE mark on the Card Printer. LVD 2006/95/EC, EMC 2004/108/EC, R&TTE 1999/5/EC, ROHS2 2011/65/EC
<b>Environmental</b>	ENERGY STAR, RoHS2, China RoHS, Power supply Efficiency level V minimum

### 1.1.1 Agency Listings

<b>Emissions and Immunity Standards</b>	FCC Part 15 Class A, RSS-GEN, RSS 210, CNS 13438, EN55022 Class A, EN55024, EN6100-3-2, EN6100-3-3, EN300-330-1, EN300-330-2, EN301-489-1, EN301-489-3, GB9254, GB17625
<b>Safety Standards</b>	UL IEC 60950-1 (2 <sup>nd</sup> edition), CSA C22.2 No. 60950-1-07( 2 <sup>nd</sup> edition), EN60950-1, GB4943, CNS14336
<b>Additional Agency Listings</b>	CCC, BSMI, KC

### 1.1.2 United States

This device complies with Part 15 of the FCC rules. Operation is subject to the following two conditions:

- (1) This device may not cause harmful interference.
- (2) This device must accept any interference received, including interference that may cause undesired operation.

**Note:** This equipment has been tested and found to comply with the limits for a Class A digital device, pursuant to part 15 of the FCC Rules. These limits are designed to provide reasonable protection against harmful interference when the equipment is operated in a commercial environment. This equipment generates, uses, and can radiate radio frequency energy and, if not installed and used in accordance with the instruction manual, may cause harmful interference to radio communications. Operation of this equipment in a residential area is likely to cause harmful interference; in which case, you are required to correct the interference at your expense.

**IMPORTANT:** Changes or modifications to an intentional or unintentional radiator not expressly approved by the party responsible for compliance could void the user's authority to operate the equipment.

### 1.1.3 Canada

This device complies with Industry Canada license-exempt RSS standard(s). Operation is subject to the following two conditions: (1) this device may not cause interference, and (2) this device must accept any interference, including interference that may cause undesired operation of the device.

Le présent appareil est conforme aux CNR d'Industrie Canada applicables aux appareils radio exempts de licence. L'exploitation est autorisée aux deux conditions suivantes : (1) l'appareil ne doit pas produire de brouillage, et (2) l'utilisateur de l'appareil doit accepter tout brouillage radioélectrique subi, même si le brouillage est susceptible d'en compromettre le fonctionnement.

### 1.1.4 Taiwan

經型式認證合格之低功率射頻電機，非經許可，公司、商號或使用者均不得擅自變更頻率、加大功率或變更原設計之特性及功能。低功率射頻電機之使用不得影響飛航安全及干擾合法通信；經發現有干擾現象時，應立即停用，並改善至無干擾時方得繼續使用。前項合法通信，指依電信法規定作業之無線電通信。低功率射頻電機須忍受合法通信或工業、科學及醫療用電波輻射性電機設備之干擾。

### 1.1.5 Japan

この装置は総務省の型式指定を受けています。"

(総務省指定番号は第AC-x x x x x号です)





本製品は電波を使用したRFID機器の読み取り・書き込み装置です。

そのため使用する用途・場所によっては、医療機器に影響を与える恐れがあります

### 1.1.6 Korea

이 기기는 업무용(A급) 전자파 적합기기로서 판매자 또는 사용자는 이 점을 주의하시길 바라며, 가정 외의 지역에서 사용하는 것을 목적으로 합니다.



## 1.2 Safety Messages (Review Carefully)

Symbol	Critical Instructions for Safety purposes
	<p>Failure to follow these guidelines results in personal injury or death.</p> <p>To prevent personal injury or death:</p> <ul style="list-style-type: none"> <li>• Reference the following safety messages before performing an operation.</li> <li>• Always remove the power cord prior to performing repair procedures, unless otherwise specified.</li> <li>• Ensure only qualified personnel perform these procedures.</li> </ul>
	<p>This device is electro statically sensitive. You may damage the device if exposing it to static electricity discharges.</p> <p>To prevent damage:</p> <ul style="list-style-type: none"> <li>• Reference the following safety messages before performing an operation.</li> <li>• Observe all established Electrostatic Discharge (ESD) procedures while handling cables in or near the Circuit Board and Printhead Assemblies.</li> <li>• Always wear an appropriate personal grounding device.</li> <li>• Always remove the Ribbon and Cards from the Printer before making any repairs, unless otherwise specified.</li> <li>• Remove jewelry and thoroughly clean hands before working on the Printer.</li> </ul>
	<p>This symbol warns of an electrical hazard that could result in personal injury or death.</p>
	<p>For safety purposes, do not use Ethernet for a direct connection outside of the building.</p>



**1.2.1 Safety Messages - Taiwan**

繁體中文 射頻發射及安全指令 安全訊息（小心檢查）

標記	重要的安全事項說明
<p>危險：</p> 	<p>未按照說明安裝可能造成人員傷亡。</p> <p>在可能產生潛在安全問題的地方有警示標記。（如左圖所示）。</p> <p>為了避免人員傷害，在進行有此警示標記的操作前，請先參考安全資訊提示。</p> <p>為了避免人員傷害，在沒有特別說明的情況下，修理前請關掉電源開關。</p>
<p>小心：</p> 	<p>此設備對靜電很敏感。如果受到靜電放電，設備會損壞。</p> <p>在可能產生潛在靜電安全問題的地方有警示標記。（如左圖所示）。</p> <p>為了避免損壞設備，在進行有此警示標記的操作前，請先參考安全資訊提示。</p> <p>為了避免損壞設備，在排放電路板和印刷頭聯合裝置裡面或附近的電線時，請注意觀察所有的靜電放電設備。</p> <p>為了避免損壞設備，請隨時佩戴合適的接地裝置（比如：手腕上戴一個高品質的接地手腕帶以免受到可能的傷害）。</p> <p>為了避免損壞設備，如果沒有特殊說明，在做任何修理前，請取下印表機上的色帶和卡。</p> <p>為了避免損壞設備，在使用印表機之前，請摘下戒指和手上飾品，並仔細清洗手上的油脂。</p>

## 1.2.2 Safety Messages - China

安全消息（请仔细阅读）

符号	涉及安全的重要过程
危险： 	<p>如果不遵循这些安装指南进行操作，可能会导致重伤，甚至死亡。</p> <p>可能引发安全问题的信息由警告符号（如左图所示）来表示。</p> <p>为了确保人身安全，在执行前面带有此符号的操作之前，请先阅读下面的安全消息。</p> <p>为了确保人身安全，除非另有规定，否则在执行维修过程前，始终应断开电源。</p>
小心： 	<p>此设备为静电敏感设备。如果暴露在静电电流下，可能会损坏设备。</p> <p>可能引发静电安全问题的信息由警告符号（如左图所示）来表示。</p> <p>为了防止设备或介质受损，在执行前面带有此符号的操作之前，请先阅读下面的安全消息。</p> <p>为了防止设备或介质受损，请在处理电路板和打印头部件中或附近的电缆时，遵守所有规定的静电放电 (ESD) 过程。</p> <p>为了防止设备或介质受损，请始终佩带适当的个人接地设备（例如，已接地避免出现潜在损坏的高质量腕带）。</p> <p>为了防止设备或介质受损，除非另有规定，否则在执行任何维修过程前，始终应将色带和证卡与打印机分离。</p> <p>为了防止设备或介质受损，在操作打印机前，请取下手指和手上的珠宝饰物，并将手上的油渍和污渍彻底清洗干净。</p>
	<p>仅适用于海拔2000m 以下地区安全使用</p> <p>Use only at altitudes not more than 2000m above sea level.</p>
	<p>仅适用于非热带气候条件下安全使用</p>
	<p>环境保护(中国-RoHS)</p> <p>环保使用期是基于本产品用于办公环境。</p> <p>Environmental Protection Use Period is based on the product being used in an office environment.</p>

## Technical Specifications

Term	Function
Print Method	Dye Sublimation / Resin Thermal Transfer
Print resolution	300 dpi (11.8 dots/mm); continuous tone
Colors	Up to 16.7 million colors / 256 shades per pixel
Print Ribbon Options	<ul style="list-style-type: none"> <li>• Full-color with resin black and overlay panel, YMCKO*, 250 prints</li> <li>• Full-color half-panel with resin black and overlay panel, YMCKO*, 350 prints</li> <li>• Full-color with two resin black panels and overlay panel, YMCKOK*, 200 prints</li> <li>• Full-color with fluorescing, two resin black panels and overlay panel, YMCFKO*, 200 prints</li> <li>• Full-color with fluorescing, two resin black panels and overlay panel, YMCFKOK*, 175 prints</li> <li>• Resin black and overlay panel, KO*, 500 prints</li> <li>• Dye-sublimation black and overlay print, BO*, 500 prints</li> <li>• Resin black (standard and premium), 1000 prints</li> <li>• Resin green, blue, red, white, silver and gold, 1000 prints</li> <li>• Rewrite technology – No ribbon is required</li> </ul> <p>* Indicates the ribbon type and the number of ribbon panels printed where Y=Yellow, M=Magenta, C=Cyan, K=Resin Black, O=Overlay, F=Fluorescing Resin</p>
Print Speed	<ul style="list-style-type: none"> <li>• 7 seconds per card (K*)</li> <li>• 12 seconds per card (KO*)</li> <li>• 24 seconds per card (YMCKO*)</li> <li>• 31 seconds per card (YMCKOK*)</li> <li>• Print speed indicates an approximate batch print speed and is measured from the time a card feeds into the printer to the time it ejects from the printer.</li> <li>• Print speeds do not include encoding time or the time needed for the PC to process the image.</li> <li>• Process time is dependent on the size of the file, the CPU, amount of RAM and the amount of available resources at the time of the print.</li> </ul> <p>* Indicates the ribbon type and the number of ribbon panels printed where Y=Yellow, M=Magenta, C=Cyan, K=Resin Black, O=Overlay, F=Fluorescing Resin</p>
Card Size and Types Supported	<ul style="list-style-type: none"> <li>• CR-80 (3.375"L x 2.125"W / 85.6mmL x 54mmW)</li> <li>• CR-79 (3.313"L x 2.063"W / 84.1mmL x 52.4mmW)</li> </ul>
Accepted Standard Card Sizes	<ul style="list-style-type: none"> <li>• CR-80 edge-to-edge (3.36"L x 2.11"W/85.3mmL x 53.7mmW)</li> <li>• CR-79 (3.3"L x 2.04"W/83.8mmL x 51.8mmW)</li> </ul>
Accepted Card Thickness	.009" - .040" / 9 mil – 40 mil/.229mm – 1.016mm

Term	Function
Accepted Card Types	PVC or polyester cards with polished PVC finish; monochrome resin required for 100% polyester cards; optical memory cards with PVC finish; rewrite
Input Hopper Card Capacity	100 cards (.030"/.762.mm) DTC1250e, DTC1000Me, DTC4250e 200 cards (.030"/.762 mm) DTC4250E (Dual Hopper)
Output Hopper Card Capacity	100 cards (.030"/.762.mm) DTC4250e 30 cards (.030"/.762.mm) DTC1250e
Reject Hopper Card Capacity	100 cards (.030"/.762.mm) – same-side input/output card hopper (required)
Card Cleaning	Card cleaning roller integrated into the ribbon cartridge. A new cleaning roller is included with each ribbon cartridge.
Printer Memory	32MB RAM
Operating Systems	Windows® XP/Vista™ (32 bit & 64 bit)/Server 2003 & 2008/Windows® 7 (32 & 64 bit)/Windows® 8 (32 & 64 bit)/Linux®
Interface	USB 2.0 and Ethernet with internal print server
Operating Temperature	65 degrees to 80 degrees F/18 degrees to 27 degrees C
Humidity	20-80% non-condensing
Dimensions	Here are the dimensions for the DTC1250e: <ul style="list-style-type: none"> <li>• Single-Sided Printer: 8.8"H x 13.7"W x 7.9"D/224mmH x 348mmW x 201mmD (DTC1000Me)</li> <li>• Dual-Sided Printer: 9.8"H x 18.7"W x 9.2"D/249mmH x 475mmW x 234mmD</li> </ul> Here are the dimensions for the DTC4250e: <ul style="list-style-type: none"> <li>• Single-Sided Printer: 9.8"H x 18.1"W x 9.2"D/249mmH x 460mmW x 234mmD</li> <li>• Dual-Sided Printer: 9.8"H x 18.7"W x 9.2"D/249mmH x 475mmW x 234mmD</li> </ul>
Weight	Single-Sided: 8 lbs./3.63 Kg; Dual-Sided: 10 lbs./4.54 Kg
Agency Listings	<b>Safety:</b> UL 60950-1, CSA C22.2 (60950-1), and CE; EMC; FCC Class A, CRC c1374, CE (EN 55022 Class A, EN 55024), CCC, BSMI, KCC
Supply Voltage	100-240 VAC, 1.6 A
Supply Frequency	50 Hz/60 Hz
Warranty	Printer – Two years; Printhead – Two years, unlimited pass with UltraCard™
Encoding Options Supported	<ul style="list-style-type: none"> <li>• 125kHz (HID Prox) reader</li> <li>• 13.56 MHz (iCLASS, MIFARE, ISO 14443 A/B, ISO 15693) read/write encoder</li> <li>• Contact Smart Card Encoder reads from and writes to all ISO7816 1/2/3/4 memory and microprocessor smart cards (T=0, T=1) as well as synchronous cards</li> <li>• ISO Magnetic Stripe Encoding, dual high- and low-coercivity, Tracks 1,2 and 3</li> </ul>

Term	Function
Options	Single Wire Ethernet and USB 2.0 Interface for inline printing and encoding <ul style="list-style-type: none"> <li>• Single wire Ethernet encoding is only available for iCLASS and Contact Smart Card encoding</li> <li>• Dual-Sided Printing Module – Upgradable</li> <li>• Dual Input Card Hopper – Upgradable (DTC4250e)</li> <li>• Same-Side Input / Output Card Hopper – Upgradable (DTC4250e)</li> <li>• Smart Card Encoding (contact/contactless) – Upgradable</li> <li>• Magnetic Stripe Encoding – Upgradable</li> <li>• Printer Clearing Kit</li> </ul>
Software	Swift ID™ Embedded Badging Application, FARGO Workbench Diagnosis Utility
Display	Color changing status buttons (DTC1250E, DTC4250E) Graphical Display (DTC4250E)

## 1.3 Functional Specifications

This card printer utilizes two different, yet closely related printing technologies to achieve its remarkable direct-to-card print quality for dye-sublimation and resin thermal transfer.

### 1.3.1 Printer Components: Print Ribbons

The card printer utilizes both dye-sublimation and/or resin thermal transfer methods to print images directly onto blank cards. Since the dye-sublimation and the resin thermal transfer print methods each provide their own unique benefits, Print Ribbons are available in resin-only, dye-sublimation-only and combination dye-sublimation/resin versions.

To make it easier to remember which print ribbons are which, a letter code has been developed to indicate the type of ribbon panels found on each ribbon. This letter code is as follows:



= Dye-Sublimation Yellow Panel



= Dye-Sublimation Magenta Panel

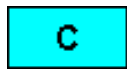

= Dye-Sublimation Cyan Panel



= Resin Black Panel (Premium unless otherwise stated)

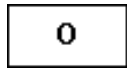

= Clear Protective Overlay Panel



= Fluorescing Panel

Ribbon	DTC1250e	DTC1000Me	DTC4250e
YMCKO – Full Color/Resin Black/Overlay	250		250
YMCKO Half Panel – Full Color (1/2)/Resin Black/Overlay	350		350
YMCFKO - Full Color/UV Fluorescing/Resin Black/Overlay			200
YMCKK - Full Color/2 Resin Black			
YMCKOK - Full Color/2 Resin Black/Overlay	200		200
YMCFKOK - Full Color/UV Fluorescing/2 Resin Black/Overlay			175
K – Standard Resin	1000	1000	1000
K – Premium Resin	1000	1000	1000
Colored Resin	1000	1000	1000
KO - Premium Black Resin/Overlay	500	500	500
BO - Dye-Sub Black/Overlay	500	500	500
None – Rewritable	Supported	Supported	Supported

### 1.3.2 Printer Components: Blank Cards

Type	Description
Card Size	The Card Printer accepts standard CR-79 and CR-80 sized cards.
Card Surface	<p>Suitable cards must have a polished PVC surface free of fingerprints, dust or any other types of embedded contaminants. In addition, cards must have a completely smooth, level surface in order for the printer to achieve consistent color coverage. Certain types of Proximity cards have an uneven surface that will inhibit consistent color transfer.</p> <ul style="list-style-type: none"> <li>Certain types of smart card chips are raised slightly above the cards surface which also results in poor color transfer.</li> </ul>
UltraCard™ Brand Cards	<p>The UltraCard™ product line, available exclusively as part of HID's Global's FARGObrand secure card issuance solutions, has a long standing reputation among dealers and end-Users for consistent quality in construction.</p> <ul style="list-style-type: none"> <li>In addition to blank stock, the UltraCard line is available in a variety of configurations for magnetic stripe, custom holograms and other additional anti-counterfeiting feature</li> <li>UltraCard Premium is the preferred card for Direct-to-Card (DTC®) applications that require a higher quality card. The UltraCard Premium's composite material construction provides for maximum durability, flexibility and card life, with optimal resolution print quality for lamination and fluorescent panel Ribbon printing applications.</li> <li>UltraCard PVC cards are medium-durability cards for a glossy, photo quality finish. These cards are manufactured to ensure clean, scratch-free cards for high-quality prints and extended Printhead life.</li> </ul>

## 2 Setup and Installation Procedures

---

This section describes the setup and installation for the DTC1250e, DTC1000Me, and the DTC4250 Card Printers.

### 2.1 Choosing a Good Location

The following guidelines help to ensure optimal printing performance:

- Place the unit in a location with adequate air circulation to prevent internal heat buildup.
- Use the printer's dimensions as a guideline for the minimum clearances to the unit.  
**Note:** Allow for adequate clearance in front of the unit to accommodate the unit with its covers open.
- Do not install unit near heat sources such as radiators or air ducts or in a place subject to direct sunlight, excessive dust, mechanical vibration or shock.

#### 2.1.1 About Moisture Condensation

If the unit is brought directly from a cold to a warm location or is placed in a very damp room, moisture may condense inside the unit. Should this occur, print quality may not be optimal.

Leave the unit unplugged in a warm, dry room for several hours before using to evaporate any moisture.



**Caution:** For safety purposes, Ethernet is not intended for a direct connection outside of the building.

### 2.2 Unpacking and Inspection

While unpacking your Printer, inspect the carton to ensure that no damage has occurred during shipping. Make sure that all supplied accessories are included with your unit.

Check that the following items are included:

- Power Supply
- US/EU Power Cable
- USB cable (2.0)
- Software Installation CD
- Card Printer User Guide
- Warranty Statement, Compliancy Document

### Installing the Print Ribbon Cartridge

FARGO Direct-to-Card Printers require highly specialized supplies to function properly.

- The FARGO DTC1250e, DTC1000Me, and DTC4250e Card Printers use a one piece, disposable ribbon cartridge system.
- To maximize printer durability, reliability and printed card quality, you must use only FARGO-certified supplies.
- For this reason, your FARGO warranty is void, where not prohibited by law, if you use non-FARGO-certified supplies.
- Printer cleaning is recommended with each ribbon change to ensure quality printed cards.
- Resin-only print ribbons consist of a continuous roll of a single resin color. No protective overlay panel (O) is provided because resin images do not require the protection of an overlay.

#### 2.2.1.1 Installing the Ribbon

Step	Procedure
1	<p data-bbox="370 758 883 785">Insert the Print Ribbon Cartridge into the Printer.</p> <div style="display: flex; justify-content: space-around; align-items: center;"> <div data-bbox="386 814 846 1209"> </div> <div data-bbox="956 1188 1216 1213">DTC1250e/DTC1000Me</div> </div> <div style="display: flex; justify-content: space-around; align-items: center; margin-top: 20px;"> <div data-bbox="420 1251 777 1535"> </div> <div data-bbox="937 1530 1266 1556">DTC4250e with Flipper Module</div> </div>

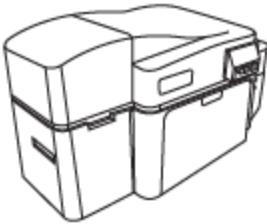

Step	Procedure
2	<p data-bbox="370 302 639 331">Close the Front Cover.</p> <div data-bbox="415 380 829 642"></div> <p data-bbox="862 632 1149 661">DTC1250e/DTC1000Me</p> <div data-bbox="391 705 656 926"></div> <p data-bbox="833 905 1198 934">DTC4250e with Flipper Module</p>

### Installing Blank Cards into the Input Card Hopper

The FARGO DTC1250e, DTC1000Me and DTC4250e Card Printers are capable of printing single feed cards and multiple feed cards (batch mode). To print a single feed card, remove all cards from the input card hopper, leave its door closed and place a card in the single feed card slot (which can be used repeatedly).

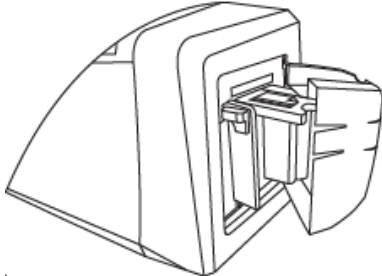
Step	Procedure
1	<p>Load the cards with the print side down and (if applicable) the magnetic strip up and towards the front of the printer.</p>  <p><b>Caution:</b> Do not run the cards with a contaminated, dull or uneven surface through the Printer.</p> <ul style="list-style-type: none"> <li>• Printing onto such cards may lead to poor print quality and can greatly reduce the life of the printhead.</li> <li>• Card types include PVC or PVC finish.</li> <li>• Cards eject into the output hopper or reject hopper.</li> <li>• Each input hopper holds 100 cards.</li> <li>• Certain types of smart card chips are raised slightly above the cards surface, which may result in poor color transfer. Design the card with white space surrounding the chip.</li> <li>• To print using single feed, remove all cards from the input card hopper, leave its door closed. Place a card in the single feed card slot (which can be used repeatedly).</li> </ul>
2	<p>Open the input card hopper door.</p> 

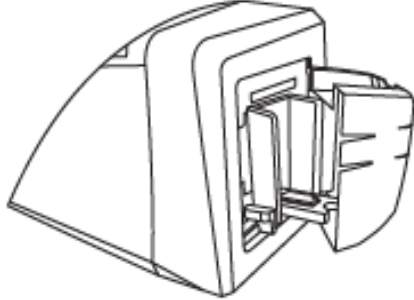
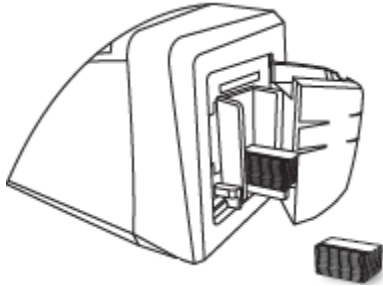
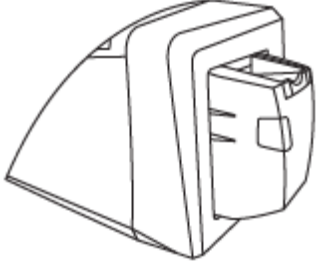
Step	Procedure
3	<p>Press the card hopper load lever down until the card tray locks into place.</p> 
4	<p>Load up to 100 cards into the hopper with the print side down. If using cards with a magnetic stripe, the magnetic stripe should be loaded with the stripe up and to the front of the Printer.</p> 
5	<p>Close the input card hopper door to release the lever to the printing position.</p> 

### 2.2.2 Setting the Card Size for CR-79 and CR-80

Follow this procedure in the printer and in the printer driver to setup the card size.

Step	Procedure
1	<p data-bbox="354 390 824 422">Open the front door and locate the slide bar.</p> 

Step	Procedure
2	<p data-bbox="354 302 1008 331">If using the CR-79 card, push the slide bar to the LEFT.</p>  <p data-bbox="690 835 1073 968">Push LEFT for CR79 card size</p>

Step	Procedure
3	<p data-bbox="354 302 1024 331">If using the CR-80 card, push the slide bar to the RIGHT.</p>  <p data-bbox="496 848 805 1003">Push RIGHT for CR80 card size</p>

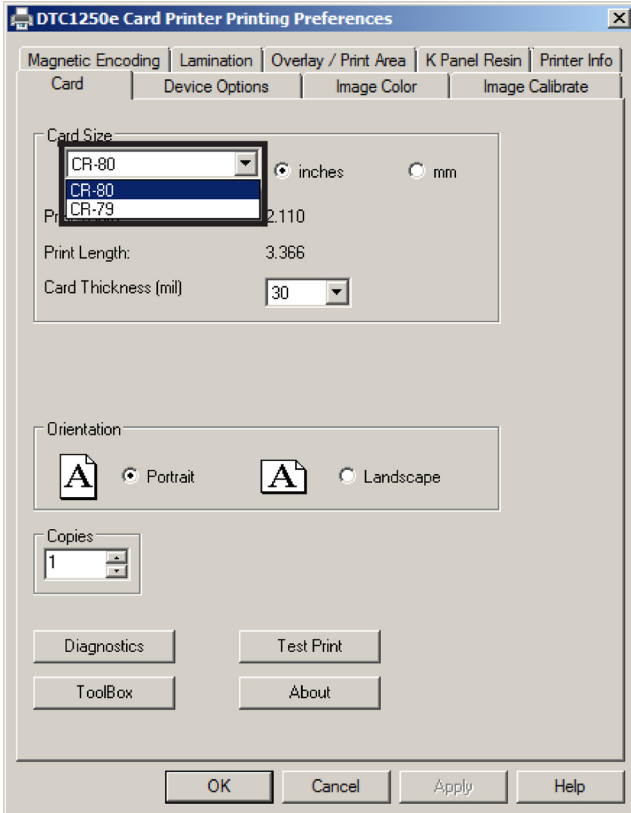
Step	Procedure
4	<p data-bbox="354 302 1127 331">From the Driver Printing Preferences, select the correct card size.</p>  <p>The screenshot shows the 'DTC1250e Card Printer Printing Preferences' dialog box. The 'Card Size' dropdown menu is open, showing three options: CR-80, CR-80, and CR-79. The 'inches' radio button is selected. Other settings include 'Print Length: 2.110', 'Card Thickness (mil): 30', and 'Orientation: Portrait'. The 'Copies' field is set to 1. Buttons for 'Diagnostics', 'Test Print', 'ToolBox', and 'About' are visible at the bottom of the dialog box. The 'OK', 'Cancel', 'Apply', and 'Help' buttons are at the very bottom.</p>

### 2.2.3 Connecting the Printer power

Follow this procedure.

**Note:** Do not connect the printer's USB cable until prompted during the printer driver installation.

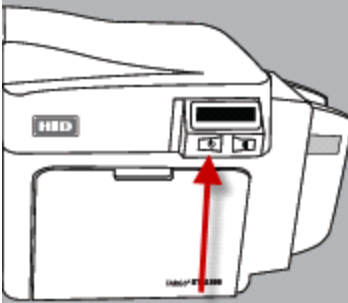
Step	Procedure
1	Plug the AC adapter power cable into the back of the Printer  
2	Plug the wall power cable into the AC power adapter.
3	Plug the wall power cable into a standard 100-240VAC power outlet.
4	Press the printer's power button to power on the printer.    <b>Note:</b> The printer powers down during the 'sleep time' but automatically powers up when a print job is sent.



### 3 Print Driver Installation

This section describes the printer driver installation requirements and standard procedures. Requirements are listed below. The DTC1250e, DTC1000Me, and DTC4250e Print Driver supports the following:

- Windows Vista 32 bit with SP2
- Windows Vista 64 bit with SP2
- Windows XP 32 bit with SP3
- Windows Server 2003 (R1) 32 bit
- Windows Server 2008 (R1) 32 bit with SP2
- Windows Server 2008 (R1) 64 bit with SP2
- Windows Server 2008 R2
- Windows 7 32 bit and 64 bit
- Windows 8 32 bit and 64 bit
- Linux OS (Ubuntu7.10, Red Hat Enterprise Desktop 5, Fecora Core 7 and 8, openSUSE 10.3, open NOVELL SUSE 10.) Contact HID/ FARGO Technical Support for the Driver.
- For more information on supported operating systems, please visit the HID Global support page.

#### 3.1 Driver Installation Instructions

Start the installation process by inserting the Driver CD into the computer; then, follow the Installaware Wizard screen prompts.

Step	Procedure
1	Select "Install the Printer Driver" to start the driver installation.
2	Select the FARGO Workbench Utility Program to install the Diagnostic program.
3	Select <b>Swift ID™</b> to install the Swift ID (Embedded Badging Application software) and follow the Installaware Wizard on-screen prompts.
4	All versions of Windows require Administrator rights.
5	From the <b>Printer &amp; Faxes</b> , select <b>Printing Preferences</b> to setup the printer driver after it has been installed.
6	Use the drop down arrows to select the correct options for each printing preference.
7	Check <b>Enable Swift ID over a USB connection:</b> to use Swift ID via a USB connection. <ul style="list-style-type: none"> <li>• When this box is checked, the Ethernet connection (if applicable) to the printer will not be operational.</li> <li>• If this selection is not accessible, this is because the HID EEM Driver that Swift ID uses to connect via a USB connection has not been installed.</li> <li>• This driver can be found on the installation CD or it can be downloaded from the HID Global support page.</li> <li>• The easiest method for enabling Swift ID is to uninstall the printer and its components and reinstall the printer with Swift ID selected.</li> </ul>

### 3.1.1 Swift ID Installation Instructions

Here are the related definitions for the Swift ID installation instructions.

- **Swift ID:** This software product is a 'built-in badging' application that enables Users to create simple ID badges without having to install any additional software.  
**Note:** This application is only intended for use between one printer and one PC. The application cannot select between printers, and only one printer per PC can access Swift ID.
- **HID ETHERNET Emulation Module (EEM) Driver:** This driver is used by Swift ID to communicate with the PC when connected via a USB cable.
- **Enable Swift ID over a USB Connection:** Check this item to utilize Swift ID via a USB connection.  
**Note:** When this box is checked, the Ethernet connection (if applicable) on the printer is disabled.
  - If this flag or selection is not accessible, the HID USB driver (that Swift ID uses to connect via a USB connection) has not been installed.  
**Note:** This driver can be found on the installation CD or it can be downloaded from the HID Global support page.
  - **Enabling Swift ID:** The easiest method for enabling Swift ID is as follows.

Step	Procedure
1	Uninstall the printer driver and its components.
2	Reinstall the printer driver and its components using the designated installation procedure.
3	Select the connection type for the Swift ID application: USB or ETHERNET.

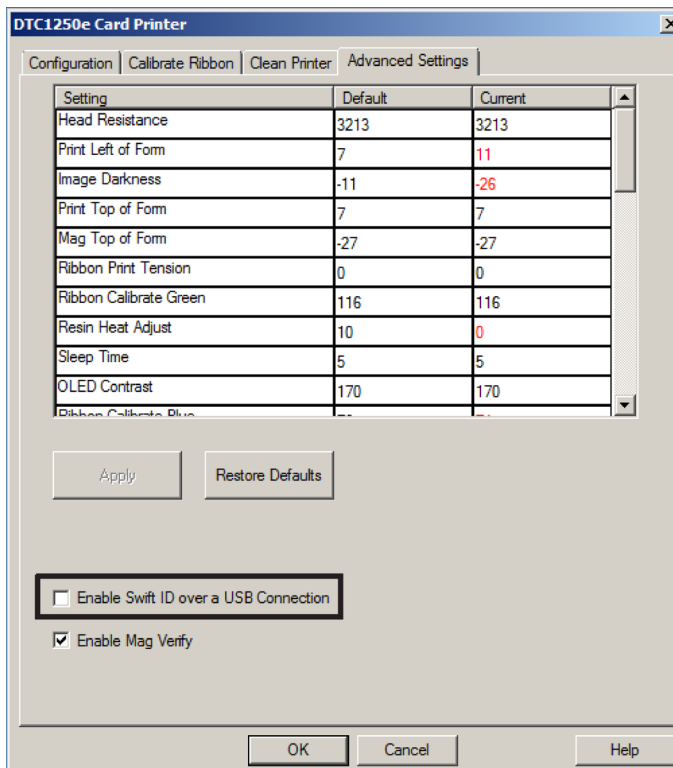



### 3.1.2 Installing Swift ID

The installation procedure varies with the method of printer connection, such as Ethernet or USB.

#### 3.1.2.1 Printer Installed On Network

Perform this procedure for a printer installed on a network.

Step	Procedure
1	Connect the printer to the network.
2	<p>Find the IP Address for a DTC4250E by navigating through the printer display.</p>  <p>The screenshot shows the following settings:</p> <ul style="list-style-type: none"> <li>User Printer Settings</li> <li>Model:</li> <li>Serial Number: 00000005</li> <li>FW Rev: 0.0.6.2 Feb 5 2010</li> <li>IP Address: 10.244.69.70</li> <li>MAC Address: 00:13:44:00:03:05</li> <li>Image Darkness: 1</li> <li>Print Top Of Form: 12</li> <li>Print End Of Form: 10</li> <li>Print Left Of Form: 16</li> <li>Mag Top Of Form: 0</li> <li>Mag End Of Form: 0</li> <li>Ribbon Print Tension: -5</li> <li>Resin Heat Adj: 10</li> <li>Erase Heat Offset: 0</li> <li>Write Heat Offset: 0</li> <li>Head Resistance: 2770</li> <li>Head Home Offset: 200</li> <li>Head Contact Offset: 103</li> <li>Display Contrast: 170</li> <li>Sleep Delay: 120 min</li> <li>Cleaning Rate: 3000 cards</li> <li>Cards Since Cleaned: 186</li> <li>Total Card Count: 186</li> </ul>

Step	Procedure
3	<p>Open a Web Browser. Type the IP Address followed by /SwiftID.html to access the Swift ID badging application.</p> <ul style="list-style-type: none"> <li>For example: 10.244.69.70/SwiftID.html</li> <li>The Getting Started with Swift ID... page displays.</li> </ul> 

### 3.1.3 Printer Connected Via USB Connection

Perform this procedure on the initial setup of a printer when connecting Swift ID via USB.

**Note:** This application is not intended for use with multiple printers.

To start using Swift ID via a USB connection with a DTC1250E or DTC4250E that has already been installed on the PC, select Option 1 or 2 and complete the procedure.

Step	Procedure
1	<p>Follow the on-screen instructions during the Printer Driver installation process to install all the required components to access Swift ID via a USB connection.</p> <p><b>Note:</b> The HID EEM Driver installs. A shortcut appears on the desktop, which allows you to easily launch the application.</p> 

#### 3.1.3.1 Option 1

Step	Procedure
1	<p>Uninstall the printer driver, reinstall the printer driver and check the <b>Enable Swift ID over a USB connection</b> check box.</p>

### 3.1.3.2 Option 2

Step	Procedure
1	Install the HID EEM Driver from the driver CD or download the HID EEM Driver installer file from the support page
2	Run the installation file.
3	When the installation is complete, check the <b>Enable Swift ID over a USB Connection</b> check box in the Advanced section of the printer driver. <b>Note:</b> When this flag is checked, a new printer instance appears and the old printer instance is no longer valid.

### 3.1.3.3 Uninstalling Swift ID

For a printer installed on a network, no steps are needed to remove any of the components of Swift ID.

For a printer that is connected via a USB connection, deselect (uncheck) the **Enable Swift ID over a USB Connection** check box in the advanced section of the printer driver and then run the uninstall HID EEM Driver setup.

**Note:** When this flag is disabled, a new printer instance appears and the old printer instance is no longer valid.

### 3.1.3.4 Additional Swift ID Rules

The following apply when (a) the HID EEM driver for Swift ID is installed on the PC for a printer and (b) a second printer with the EEM flag enabled is connected to the PC:

- A Printer instance appears for the second printer; however, a second shortcut for Swift ID does not appear.  
**Note:** Swift ID is not intended to operate with two printers.
- If both Printers are connected to the PC, the printer that is first powered on is tied into Swift ID.

The following apply when (a) the EEM driver is not installed on the PC and (b) another printer (same model) with EEM disabled is connected to the PC.

- A printer driver instance appears.
- The User is not asked to enable EEM for the printer.
- The HID EEM driver is not installed for the printer on the PC.
- The EEM flag in the printer driver is 'grayed out' so that the User cannot change this state.

## 4 Printer Preferences

This section provides an overview of the Printing Preferences tabs.

### 4.1 Card

The **Card** tab provides options that define the basic characteristics of a card - the size and orientation.

The Card tab also provides access to helpful utilities and information:

- Diagnostics
- Test Print
- ToolBox
- About

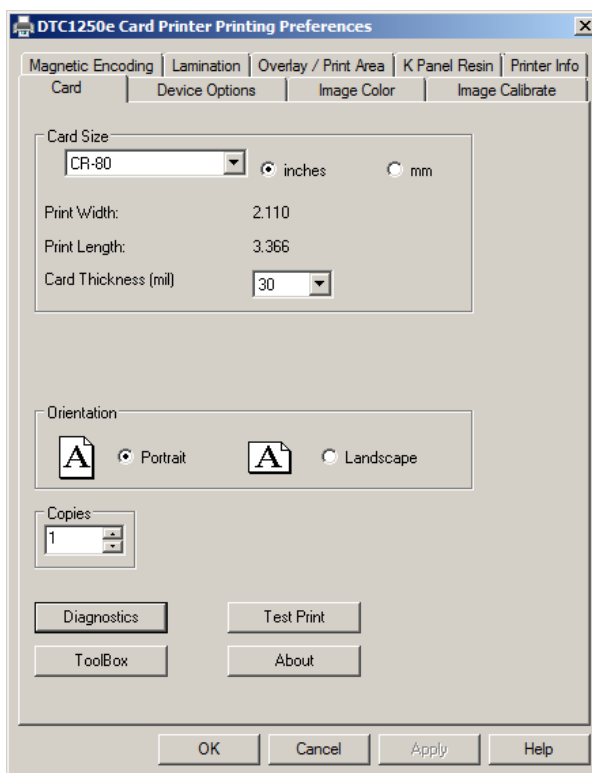

#### 4.1.1 Card Size

The **Card Size** area includes the following fields:

- **Standard card size** – Select **CR-80** or **CR-79**.
- **Measurement units** – Select **inches** or **mm** (millimeters).
- **Print Width** – Displays width dimension of the card.
- **Print Length** – Displays length dimension of the card.
- **Card Thickness (mil)** – Select the card thickness in mils.

#### 4.1.2 Orientation

Select **Portrait** for vertical orientation or **Landscape** for horizontal orientation.

#### 4.1.3 Copies

Select the number of copies to print using **Test Print**.

### 4.2 Diagnostics

Click **Diagnostics** to access the Workbench 3 utility. See the Workbench 3 User Guide or Workbench 3 Help facility for more information.

### 4.3 Test Print

Click **Test Print** to send one or more self-test prints to the printer.

### 4.4 Toolbox

Click the **Toolbox** button for access to the following Toolbox options:

- Configuration
- Calibrate Ribbon
- Clean Printer
- Advanced Settings

#### 4.4.1 Configuration

This option is used to show the currently installed Optional Printer features, Event Monitoring, to set the Printer Driver language and Printer Display language.

#### 4.4.1.1 Set Language

To switch between languages, select the preferred language, select **OK** twice and then open the driver in the preferred language.

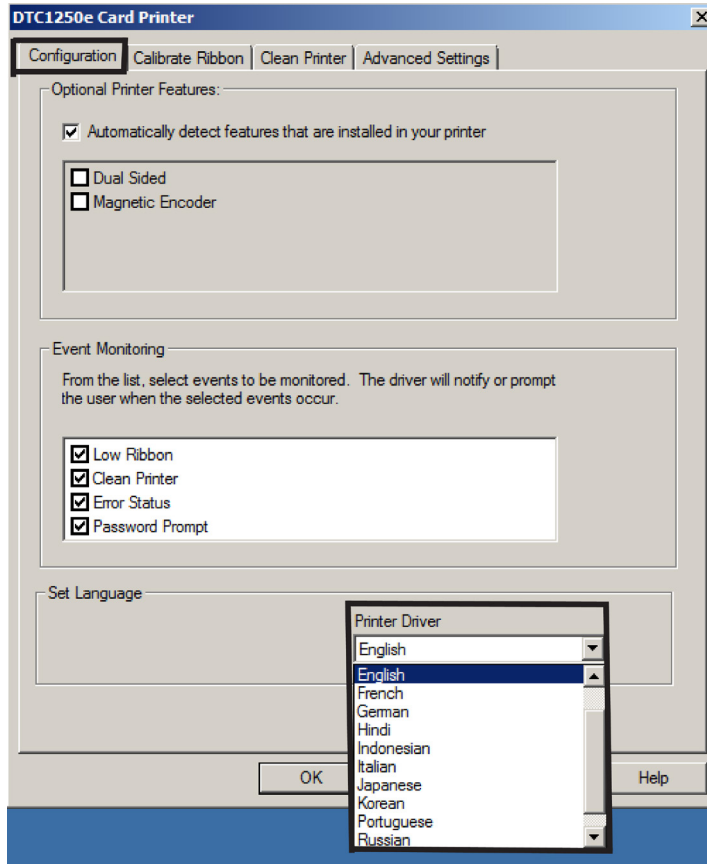



## 4.5 Calibrate Ribbon

The **Calibrate** button sends the Calibrate Ribbon command to printer. Follow the procedure below to setup the printer.

Step	Procedure
1	Remove the ribbon cartridge from the printer.
2	Close the printer's front cover.
3	Select the <b>Calibrate Ribbon</b> tab.
4	Click <b>Calibrate</b> .

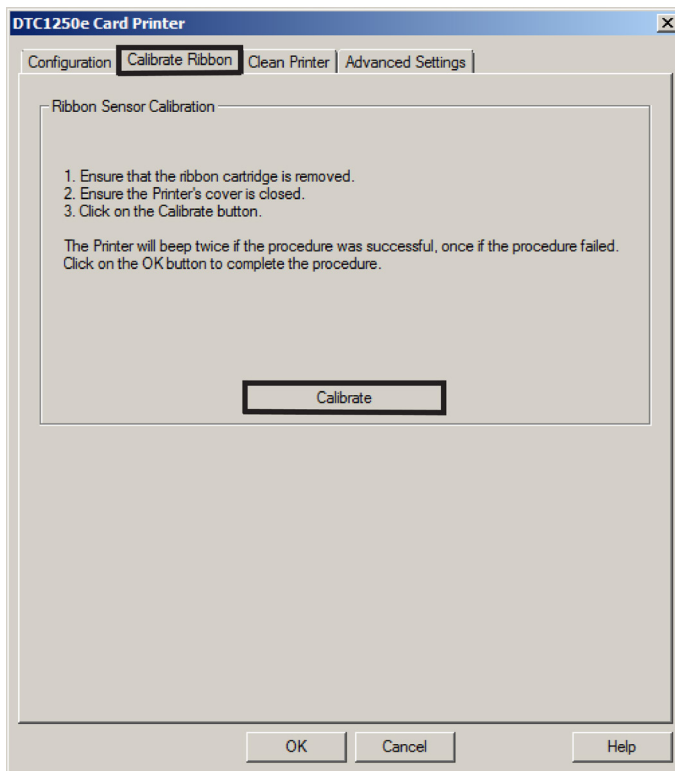



## 4.6 Clean Printer

The button for the Clean Printer tab is described below.

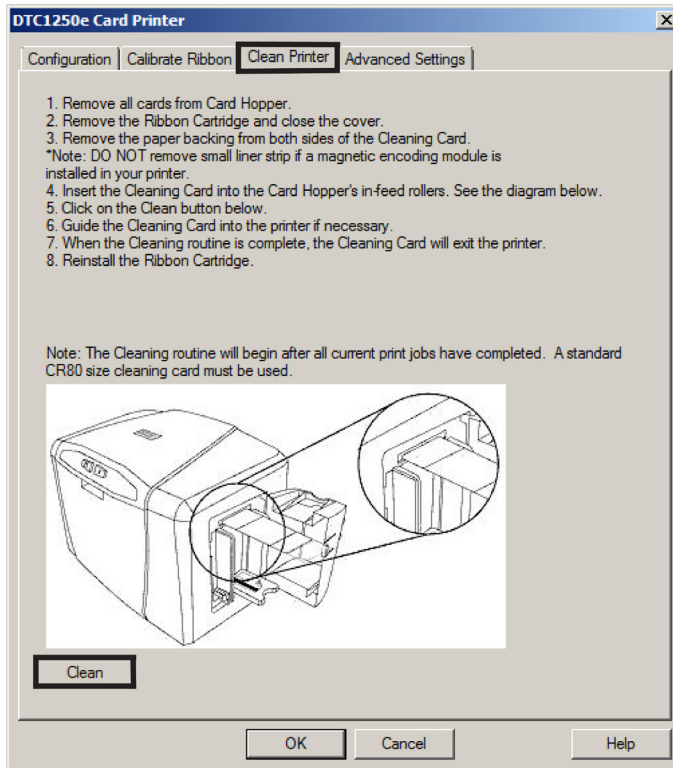
- **Clean Button:** Launches the cleaning routine. Follow the instruction on the page for setting up the Printer.



**4.6.1 Safety Messages (Review Carefully)**



Symbol	Critical Instructions for Safety purposes
<p><b>Danger:</b></p> 	<p><b>Failure to follow these installation guidelines can result in death or serious injury.</b></p> <p>Information that raises potential safety issues is indicated by a warning symbol (as shown to the left).</p> <ul style="list-style-type: none"> <li>• <b>To prevent personal injury</b>, refer to the following safety messages before performing an operation preceded by this symbol.</li> <li>• <b>To prevent personal injury</b>, always remove the power cord prior to performing repair procedures, unless otherwise specified.</li> <li>• <b>To prevent personal injury</b>, make sure only qualified personnel perform these procedures.</li> </ul>
<p><b>Caution:</b></p> 	<p><b>This device is electrostatically sensitive. It may be damaged if exposed to static electricity discharges.</b></p> <p>Information that raises potential electrostatic safety issues is indicated by a warning symbol (as shown to the left).</p> <ul style="list-style-type: none"> <li>• <b>To prevent equipment or media damage</b>, refer to the following safety messages before performing an operation preceded by this symbol.</li> <li>• <b>To prevent equipment or media damage</b>, observe all established Electrostatic Discharge (ESD) procedures while handling cables in or near the Circuit Board and Printhead Assemblies.</li> <li>• <b>To prevent equipment or media damage</b>, always wear an appropriate personal grounding device (e.g., a high quality wrist strap grounded to avoid potential damage).</li> <li>• <b>To prevent equipment or media damage</b>, always remove the Ribbon and Cards from the Printer before making any repairs, unless otherwise specified.</li> <li>• <b>To prevent equipment or media damage</b>, take jewelry off of fingers and hands, as well as thoroughly clean hands to remove oil and debris before working on the Printer.</li> </ul>

### 4.6.2 Cleaning Kit



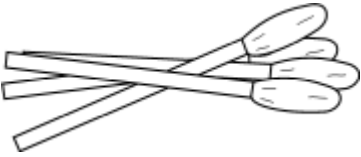

**Caution:** As with any electronic device, internal components of the printer, such as the printhead, may be damaged if exposed to static electrical discharges. To avoid potential damage, always wear an appropriate personal grounding device, such as a wrist strap (with integral resistor) connected to an ESD ground.

This Cleaning Kit provides you with the specialized cleaning supplies and the required cleaning procedures for you to maintain your card printer/encoder. The following cleaning procedures will require less than 10 minutes.

Description	Supplies (pictured)
<p><b>Four (4) Printhead Cleaning Swabs</b> are pre-moistened with 99.99% isopropyl alcohol for cleaning your printer's printhead.</p>	
<p><b>Three (3) Alcohol Cards</b> are premoistened with 99.99% isopropyl alcohol for cleaning your printer's platen, and card feed rollers.</p>	
<p><b>Ten (10) Cleaning Cards</b> are provided with adhesive backing for cleaning your printer's platen and card feed rollers.</p>	



**4.6.3 Printhead Cleaning**

Step	Procedure
1	 <b>Caution:</b> Turn Off the printer and unplug the power cord from the printer.
2	Remove the ribbon cartridge.
3	Open the Printhead Cleaning Swabs. Break it to moisten the tip.
4	Swab the tip back and forth across the top of the printhead. Allow to dry thoroughly before sending a print job. 

### Cleaning the Platen and the Card Feed Rollers

Perform this procedure approximately every **1000 prints** to maintain a consistent print quality.

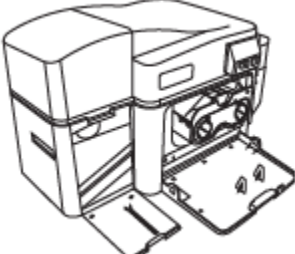
**Note:** The card feed rollers move the card throughout the print process. Rollers should be kept clean to prevent card jams and card contamination. This cleaning process will ultimately lead to better print quality and extended printhead life.

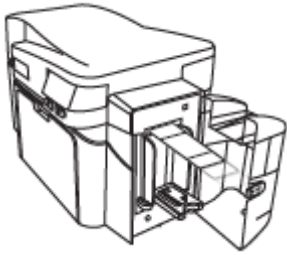
Step	Procedure
1	<p>Open the printer's front cover, remove the print ribbon and close the front cover. Remove all the cards from the printer's input card hopper.</p> 
2	<p>Use the cleaning card from the cleaning kit and remove the adhesive backing from both sides of the card.</p> <ul style="list-style-type: none"> <li>• If your printer has a magnetic encoder installed, be sure to leave the small liner strip on top of the cleaning card in place.</li> <li>• This small strip is needed to protect the magnetic head from the adhesives on the cleaning card.</li> </ul> 
3	<p>Insert the cleaning card into the single feed card slot until the card stops. If your printer is equipped with a magnetic encoder, you must insert the cleaning card with the printed side up and with the small liner strip towards the front of the printer.</p> 
4	<p>From your computer, open the printer driver and select <b>Printing Preferences</b>.</p>

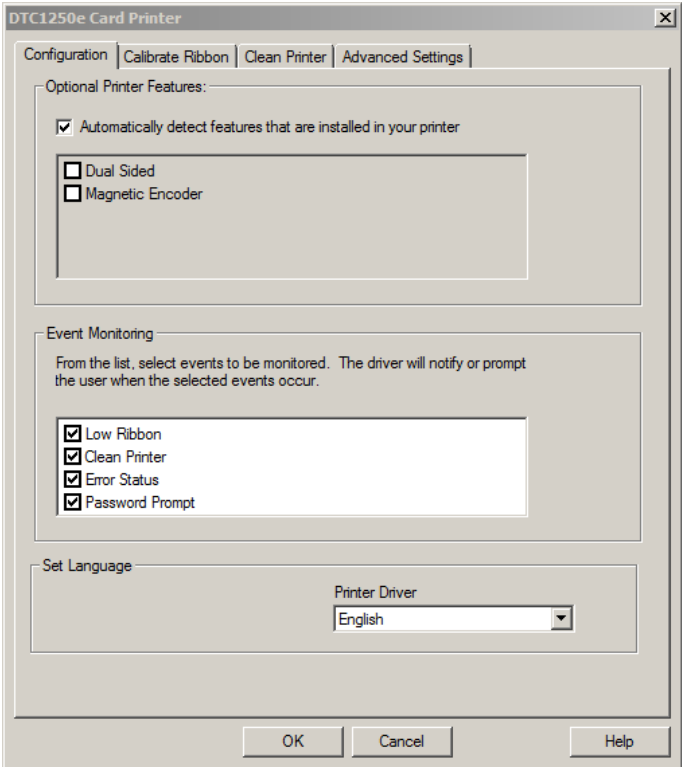
Step	Procedure
5	<p data-bbox="354 296 511 317">Click <b>Toolbox</b>.</p> 

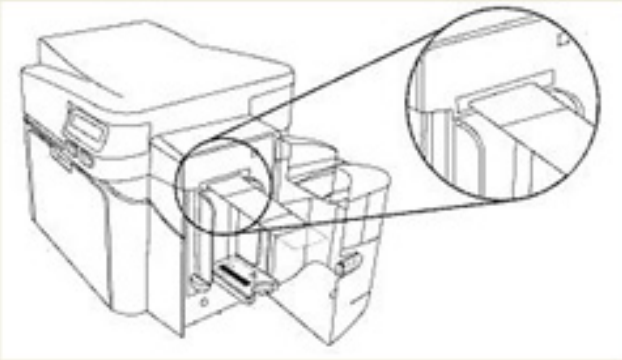
Step	Procedure
6	<p>Select the <b>Clean Printer</b> tab.</p> <div data-bbox="365 331 1279 1276" style="border: 1px solid black; padding: 10px;"> <p>Configuration   Calibrate Ribbon   <b>Clean Printer</b>   Advanced Settings</p> <ol style="list-style-type: none"> <li>1. Remove all cards from Card Hopper.</li> <li>2. Remove the Ribbon Cartridge and close the cover.</li> <li>3. Remove the paper backing from both sides of the Cleaning Card.</li> <li>*Note: DO NOT remove small liner strip if a magnetic encoding module is installed in your printer.</li> <li>4. Insert the Cleaning Card into the Card Hopper's in-feed rollers. See the diagram below.</li> <li>5. Click on the Clean button below.</li> <li>6. Guide the Cleaning Card into the printer if necessary.</li> <li>7. When the Cleaning routine is complete, the Cleaning Card will exit the printer.</li> <li>8. Reinstall the Ribbon Cartridge.</li> </ol> <p>Note: The Cleaning routine will begin after all current print jobs have completed.</p>  <p style="text-align: center;">Clean</p> <p style="text-align: center;">OK      Cancel      Help</p> </div>
7	<p>Click <b>Clean</b> (shown above).</p> <ul style="list-style-type: none"> <li>• The printer pulls in the cleaning card. The printer performs the automated cleaning procedure.</li> <li>• This procedure is designed to thoroughly clean the platen and the card feed rollers inside the printer.</li> </ul>



#### 4.6.4 Cleaning the Printer’s Exterior

Clean the printer only with a microfiber cloth. Do not drip water into the printer. Dry thoroughly before printing.

**Note:** The printer has a durable casing that should retain its luster and appearance for many years.

### 4.7 Advanced Settings

Use the **Advanced Settings** tab for adjusting the internal printer settings, which are customized for every printer at the factory and saved directly within the printer's memory.

**Note:** You can select the **Restore Defaults** to restore the internal default settings.

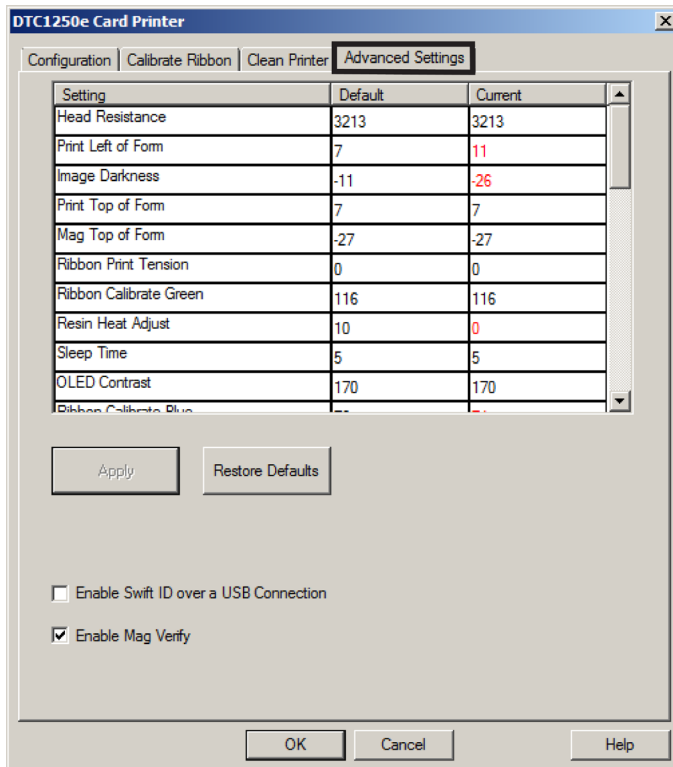

Settings enable users to change the values for firmware settings by clicking on the Current column.

- **Setting Column:** Displays label for setting
- **Default Column:** Displays default value for setting
- **Current Column:** Displays current value for setting
- **Apply Button:** Applies changed values.
- **Restore Defaults Button:** Restores the default values.
- **Enable Swift ID over a USB connection:** Check this box to use Swift ID when your printer is connected using USB.
- **Enable Mag Verify:** Check this box to verify that the data is written to the tracks correctly.



Example:

Setting	Default	Current
Image Darkness	0	-14

Setting	Description
<b>Head Resistance</b>	This is factory set. If the main board or the Printhead is replaced then adjust this number. Locate the Printhead Setting Number on the bottom of the Printhead. The number reads R=XXXX.
<b>Print Left of Form</b>	Use this option to adjust the vertical position of the printed image on the card; so it appears centered. <ul style="list-style-type: none"> <li>• Maximum Adjustment Range is +/- 127.</li> <li>• Each increment equals .01".</li> </ul>
<b>Image Darkness</b>	Use this option to set the overall darkness of the printed image by increasing or decreasing the amount of heat (used by the Printhead when printing).  <b>Caution:</b> If the value is set too high, the Ribbon may jam or even break.
<b>Print Top of Form</b>	Use this option to adjust the length-wise or horizontal position of the printed image on the card (so it appears to be centered).  <b>Caution:</b> If the negative value is set too high, the Print Ribbon may break.
<b>Mag Top of Form</b>	Use this option to shift the starting point where the Printer begins to encode the magnetic track data on the card's Magnetic Stripe.  <b>Caution:</b> If the negative value is set too high, the Printer may start encoding before the Magnetic Stripe reaches the encoding head. <ul style="list-style-type: none"> <li>• Maximum adjustment range is +/- 80.</li> <li>• Each increment equals .01".</li> </ul>
<b>Ribbon Print Tension</b>	Use the Ribbon Tension option to increase or decreases the amount of tension (drag) on the Ribbon during printing.
<b>Ribbon Calibrate Green</b>	This is a calibration driven value and should not be adjusted. <b>Note:</b> This is factory set and should not be changed unless directed by a technician.
<b>Resin Heat Adjust</b>	Use this adjustment for Black premium resin text and barcodes if they appear faded, too light or too dark. Maximum Adjustment Range is +/- 100. <b>Note:</b> This control can be helpful for fine-tuning the transfer of resin text and bar codes.
<b>Sleep Time</b>	The Sleep Time setting adjusts the number of minutes of inactivity before the Printer enters a low power sleep state.

Setting	Description
<b>OLED Contrast (display contrast)</b>	Use this option to increase or decrease the contrast of the printer OLED (if applicable).
<b>Ribbon Calibrate Blue</b>	This setting is a calibration driven value and should not be adjusted. It is factory set and should not be changed unless directed by a technician.
<b>Cleaning Rate</b>	Use this option to adjust the number of cards printed before the Printer displays a message indicating cleaning is needed. <ul style="list-style-type: none"> <li>The default value is 3000 cards.</li> </ul>
<b>Mag HI-Co Voltage Offset</b>	This setting is a calibration driven value and should not be adjusted. It is factory set and should not be changed unless directed by a technician.
<b>Mag Lo-Co Voltage Offset</b>	This setting is a calibration driven value and should not be adjusted. It is factory set and should not be changed unless directed by a technician.
<b>Ribbon Green LED Level</b>	This setting is a calibration driven value and should not be adjusted. It is factory set and should not be changed unless directed by a technician.
<b>Ribbon Blue LED Level</b>	This setting is a calibration driven value and should not be adjusted. It is factory set and should not be changed unless directed by a technician.
<b>Erase Heat Offset</b>	Adjust the Erase temperature for the rewriteable cards as needed. Increase the <b>Current Setting</b> to cause more heat to be used in the erasing process. <b>OR</b> Decrease the <b>Current Setting</b> to cause less heat to be used in the erasing process. <b>Note: Erase Heat Offset</b> provides user ability to control the Printhead heat level when the Erase Operation is performed. Appropriate heat levels should be applied for the proper erase process. This setting should be adjusted for proper erasure.
<b>Write Heat Offset</b>	Adjust the Write temperature for the rewriteable cards as needed. Increase the <b>Current Setting</b> to cause more heat to be used in the printing process of a rewritable card. <b>OR</b> Decrease the <b>Current Setting</b> to cause less heat to be used in the printing process of a rewritable card. <b>Note: Write Heat Offset</b> provides user capability to control the printhead heat level when the Write Operation is performed. Appropriate heat levels should be applied for the proper writing process.

Setting	Description
<b>Flipper Home Offset</b>	This setting is a calibration driven value and should not be adjusted. If the Flipper unit is replaced and has not been calibrated this value may need to be adjusted. This setting is factory set and should not be changed unless directed by a technician.
<b>Flipper Eject Height Offset</b>	This setting is a calibration driven value and should not be adjusted. If the Flipper unit is replaced and has not been calibrated this value may need to be adjusted. This setting is factory set and should not be changed unless directed by a technician.
<b>Mag Super-Co Voltage Offset</b>	This option changes the voltage going the magnetic head. This setting is factory set and should not be changed unless directed by a technician..
<b>Mag Medium-Co Voltage Offset</b>	This option changes the voltage going the magnetic head. This setting is factory set and should not be changed unless directed by a technician.
<b>Head Home Offset</b>	This setting is a calibration driven value and should not be adjusted. If the Printhead assembly is replaced then this value may need to be adjusted. This setting is factory set and should not be changed unless directed by a technician
<b>Head Print Offset</b>	This setting is a calibration driven value and should not be adjusted. If the printhead assembly is replaced then this value may need to be adjusted. This setting is factory set and should not be changed unless directed by a technician.
<b>Head Contact Offset</b>	This setting is a calibration driven value and should not be adjusted. If the printhead assembly is replaced then this value may need to be adjusted. This setting is factory set and should not be changed unless directed by a technician.
<b>Head Queue Offset</b>	This setting is a calibration driven value and should not be adjusted. If the printhead assembly is replaced then this value may need to be adjusted. This setting is factory set and should not be changed unless directed by a technician.
<b>Head Card Thickness Offset</b>	Adjusts the card handling path to allow for variances in card thickness.
<b>Head Smart Card Engage Offset</b>	Adjusts the position of the print head to allow smart card encoder contact.
<b>Head Mag Offset</b>	Adjusts the printhead for magnetic encoding.
<b>Overlay Heat Adjust</b>	Adjusts the temperature setting for overlay film.
<b>10 Mil Card Queue Offset</b>	Adjusts the input queue for use with thick cards.
<b>Erase Speed</b>	Adjusts the speed of the erasure process.

Setting	Description
<b>Standard Resin Head Adjust</b>	Use this adjustment for Black standard resin text and barcodes if they appear faded, too light or too dark. Maximum Adjustment Range is +/- 100. This control can be helpful for fine-tuning the transfer of resin text and bar codes.
<b>Printhead Smart Cue Offset</b>	Adjusts the card handling path to allow for variances in card thickness.
<b>Enable Swift ID over USB connection</b>	Check this item to utilize Swift ID via a USB connection. When this box is checked the Ethernet connection (if applicable) on the printer will not be operational. <ul style="list-style-type: none"> <li>• If the USB selection is not be accessible, the HID EEM driver that Swift ID uses to connect via a USB connection has not been installed.</li> <li>• This driver can be found on the installation CD or it can be down loaded from the HID Global support page.</li> <li>• The easiest method for enabling Swift ID is to un-install the printer driver and its components and go through the installation procedure. During installation, select the connection type for the Swift ID application: USB or Ethernet.</li> </ul>

## 4.8 Device Options

Click **Device Options** to display the **Supplies**, **Dual Sided** and **Options** areas.

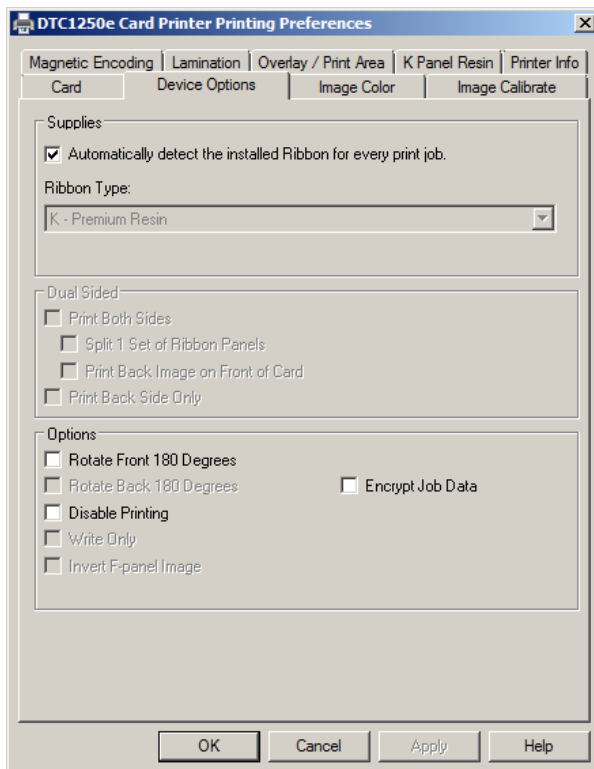

### 4.8.1 Supplies

Click **Automatically detect the installed Ribbon for every print job.** to verify that the ribbon type selected matches the installed ribbon. The printer changes the ribbon type to the correct setting. The dialog indicates that the current setting has changed or that the current ribbon type is correct.

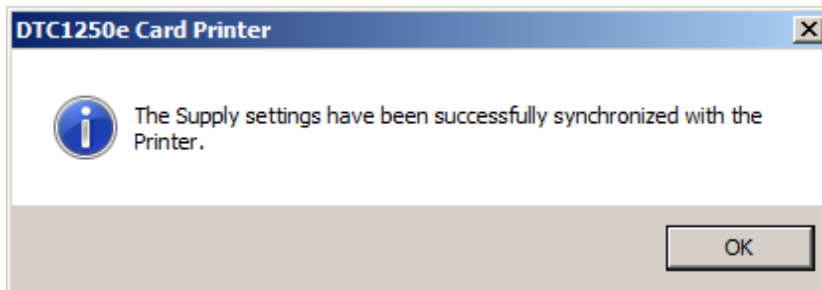

To manually select the ribbon type:

1. Deselect **Automatically detect the installed Ribbon for every print job.**
2. Click the drop-down button of the **Ribbon Type** field.
3. Select the preferred ribbon type. The available choices will vary, based on compatibility with your printer model. For rewritable cards, select **None – Re-Writable.**

### 4.8.2 Dual Sided

Checkboxes provide the capability to select two-sided printing options:

- **Print Both Sides** – Click to automatically print the front and back sides of the card.
- **Split 1 Set of Ribbon Panels** – Click to automatically print the front and back sides of the card using one ribbon panel.
- **Print Back Image on Front of Card** – Click to print the first page of a two-page print file on the card's backside. This option can also be used to print black resin on a smart card's chip side.  
**Note:** The second page of the file is printed on the card's front side.
- **Print Back Side Only** – Click to print only on the card's back side.

The Dual Sided area is grayed out when the printer is single-sided only.

### 4.8.3 Options

Checkboxes provide the capability to select additional print options:

- **Rotate Front 180 Degrees** – Click to change the orientation of the first page of the card design to accommodate the location of a chip or RFID sensor.
- **Rotate Back 180 Degrees** – Click to change the orientation of the second page of the card design to accommodate the location of a chip or RFID sensor.
- **Disable Printing** – Click to prevent the printer from printing.
- **Invert F-panel Image** – Click to change the portion of an image that is printed using a fluorescent film panel.

- **Write Only** – Click to use rewritable cards. The default setup is for the printer to first erase the entire card and then write new information on the card. There is no option to select specific areas to erase. However, to print or erase a section, use the **Overlay/Print Area** tab. Select the specific area in the same manner as a print job with a color ribbon. To erase many cards, use the **FARGO Workbench Re-Writable Card Eraser** option. It does not print. It only erases.  
**Note:** No ribbon is used with rewritable cards. Do not load a ribbon into the printer when using this process. Printing on a rewritable card with a ribbon will ruin the card.
- **Encrypt Job Data** – Click to encrypt information about the print job for enhanced security.

## 4.9 Image Color

Use the **Image Color** tab to improve the quality of the image on the card. Image Color includes two areas, **Image Quality** and **Heat**.

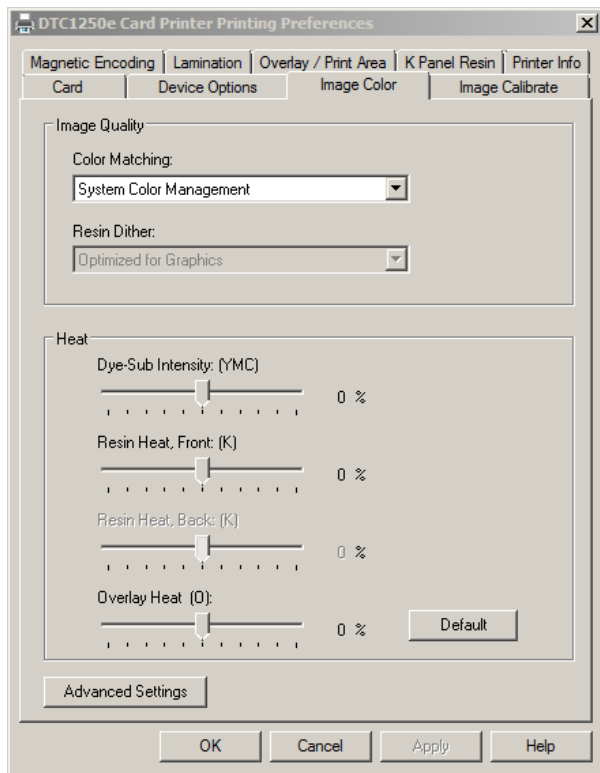

### 4.9.1 Image Quality

The **Image Quality** area includes two fields, **Color Matching** and **Resin Dither**.

- **Color Matching** – Three options are available:
  - **None** – Select:
    - (a) if interested in print speed rather than print color
    - (b) if color correcting an image that has been previously printed, or
    - (c) if using third-party color matching software
  - **System Color Management** – Select to perform color correction through a complex color-matching algorithm.  
**Note:** This option shifts colors so they more closely match how they appear on screen.
  - **Algebraic** – Select to use the Algebraic color-matching algorithm.
- **Dither** – Select the appropriate dither method according to the type of image to be printed. Graphics include images such as drawings, clipart and logos. Photos include images such as photographs and photo-quality images. This option affects objects printed with a resin-only ribbon.

### 4.9.2 Heat

The **Heat** area includes sliders for adjusting the temperature when printing with various types of ribbons:

- **Dye-Sub Intensity (YMC)** – Control the overall darkness and lightness of the dye-sub printed image by moving the slider to the left to use less heat in the printing process, resulting in a lighter print. Move the slider to the right to use more heat, resulting in a darker print.  
**Note:** This slide only affects those images printed with dye-sublimation ribbon panels (YMC).
- **Resin Heat, Front (K)** – Move the slider to the left to use less heat in the printing process, resulting in a lighter or less saturated print. Move the slider to the right to use more heat, resulting in a darker or more saturated print.  
**Note:** This control can be helpful for fine-tuning the sharpness of resin text and bar codes.
- **Resin Heat, Back (K)** – Move the slider to the left to use less heat in the printing process, resulting in a lighter or less saturated print. Move the slider to the right to use more heat, resulting in a darker or more saturated print.
- **Overlay Heat (O)** – Move the slider to the left to use less heat in the printing process. Move the slider to the right to use more heat.

### 4.9.3 Default

Click the **Default** button to return all options to their factory settings.



#### 4.9.4 Advanced Settings

Click the **Advanced Settings** button to display the **Advanced Image Color** window.

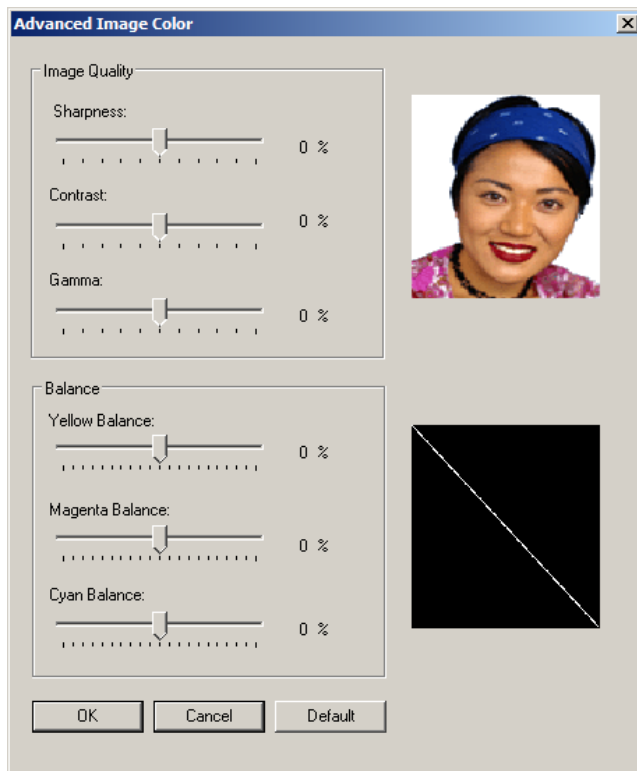

The Advanced Image Color window includes the **Image Quality** and **Balance** areas.

- **Image Quality** – Three options are available:
  - **Sharpness** – Move the slider to the right to sharpen the image. Move the slider to the left to decrease sharpness.
  - **Contrast** – Move the slider to the right to increase contrast in the image. Move the slider to the left to decrease contrast.
  - **Gamma** – Move the slider to the right to increase gamma in the image. Move the slider to the left to decrease gamma.
- **Balance** – Three options are available:
  - **Yellow Balance** – Move the slider to the right to increase the amount of yellow in the image. Move the slider to the left to decrease the amount of yellow.
  - **Magenta Balance** – Move the slider to the right to increase the amount of magenta in the image. Move the slider to the left to decrease the amount of magenta.
  - **Cyan Balance** – Move the slider to the right to increase the amount of yellow in the cyan. Move the slider to the left to decrease the amount of cyan.

Click the **Default** button to return all options to their factory settings.

## 4.10 Image Calibrate

Use the **Image Calibrate** tab to control the position of the printable area in relation to the card.

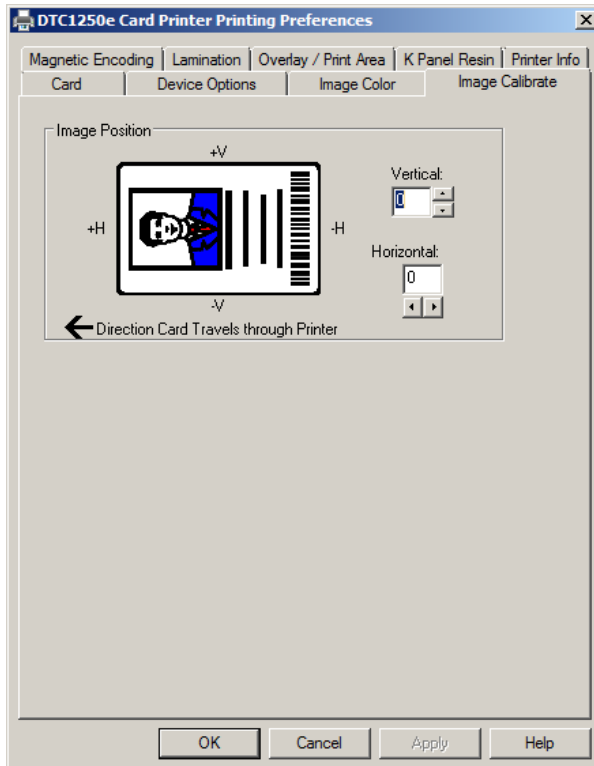

Use the Vertical and Horizontal image position controls to adjust the position of the overall print area to be precisely centered on a card. The maximum value for the Vertical and Horizontal adjustments is  $\pm 100$  pixels (10 pixels = about .03%, .8mm).

- **Vertical** – Use the Vertical adjustment to move the image toward the rear of the printer, if the adjustment is a positive number. Enter a negative number to move the image toward the front of the printer.
- **Horizontal** – Use the Horizontal adjustment to move the image toward the card output side of the printer, if the adjustment is a positive number. Enter a negative number to move the image toward the input side of the printer.

## 4.11 Magnetic Encoding

Select the **Magnetic Encoding** tab to display options for controlling the Magnetic Stripe encoding process. You can use these options only if the printer has an optional Magnetic Stripe Encoding Module installed.

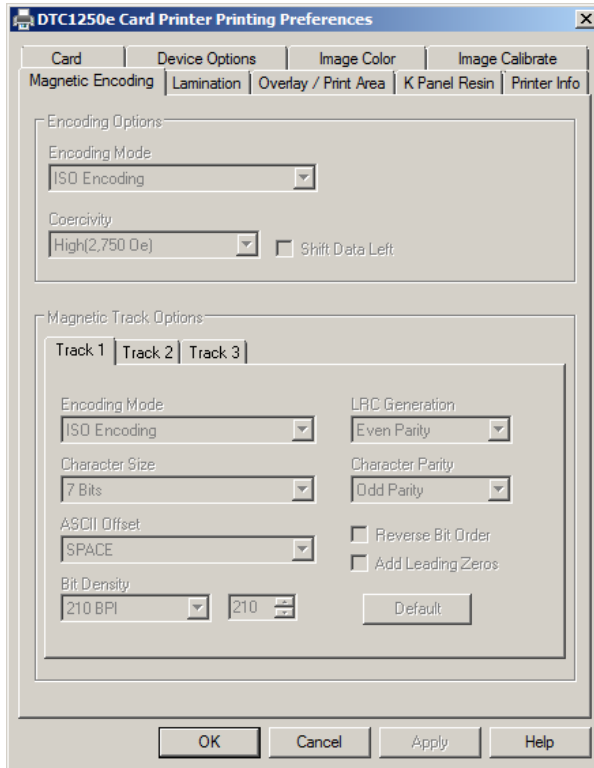

The Magnetic Encoding tab includes two areas, **Encoding Options** and **Magnetic Track Options**.

### 4.11.1 Encoding Options



Two encoding modes are available, ISO Encoding and Custom Encoding or Raw Binary Encoding Mode.

**ISO Encoding** – You can change the encoding mode and coercivity setting or modify the ISO standards for Tracks 1, 2 and 3. This can be done by correctly modifying these Magnetic Encoding options.

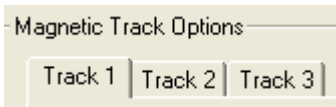
Window Tab	Procedure	Procedure (continued)
	<p>If you select <b>ISO Encoding</b>, you send down a formatted set of characters.</p>	<p>This selection activates the track tabs. However, all functions on the Track tabs are inactive or gray and display ISO defaults, which are the defaults listed for each track below. The <b>Shift Data Left</b> check box remains unchecked and inactive.</p>
	<p>If you select <b>Custom Encoding</b>, all options are active.</p>	<p>The <b>Default</b> is ISO Encoding. <b>Note:</b> The defaults are the same as the ISO Encoding defaults. All functions on the Magnetic Track Options tabs are active.</p>
	<p>If you select <b>Raw Binary Encoding</b>, you send down a raw binary string rather than a formatted set of characters.</p>	<p>The <b>Coercivity</b> dropdown function is active and the <b>Shift Data Left</b> checkbox is not active. All functions on the Magnetic Track Options tabs are inactive except for <b>Bit Density</b>.</p>
	<p>If you select <b>JIS II Encoding</b>, specific standards are used.</p>	<p>This selection disables all the Magnetic Track Options tabs. It also disables the Coercivity dropdown function and <b>Shift Data Left</b> checkbox option. The default Coercivity is 600 Oe.</p>
	<p>Select the <b>Coercivity</b> option (Oersted) that matches the card type.</p>	<ul style="list-style-type: none"> <li>• High Coercivity 4000 Oersted</li> <li>• FARGO's High Coercivity UltraCard IIIs are 2750 Oersted</li> <li>• Medium Coercivity=600 Oersted</li> <li>• Low Coercivity = 300 Oersted</li> </ul>
	<p>Select this option to shift the recorded magnetic data to the left-hand side of the card's Magnetic Stripe.</p>	<p>This is useful in situations that require cards to be readable with insert type readers.</p>

Window Tab	Procedure	Procedure (continued)
	<p>Select the <b>Magnetic Track Selection</b> option to specify which track is to be configured through the Magnetic Track Options.</p>	<p>This applies if the application being used <u>requires</u> customization of the standard ISO encoding process.</p>

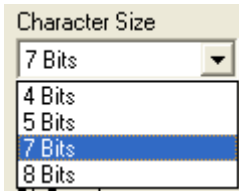
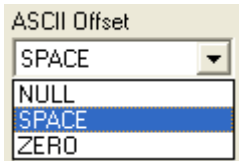
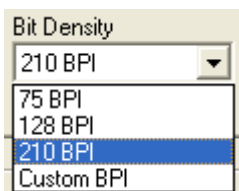
- **Custom Encoding or Raw Binary Encoding Mode** – You can change the Magnetic Track options for Tracks 1, 2 and 3 when using the Custom Encoding or Raw Binary Encoding Mode. These options are not available for ISO or JIS II encoding.

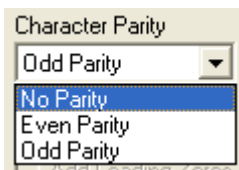
Window TAB	Procedure	Procedure (continued)
	<p>Select <b>4 Bits</b> to change the bits per character to 4 BPC.  <b>Note:</b> This is the default for Track 3.</p> <p>Select <b>5 Bits</b> to change the bits per character to 5 BPC.  <b>Note:</b> This is the default for Tracks 2 and 3.</p>	<p>Select <b>7 Bits</b> to change the bits per character to 7 BPC.  <b>Note:</b> This is the default for Track 1.</p> <p>Select <b>8 Bits</b> to change the bits per character to 8 BPC.</p>
	<p>Select <b>NULL</b> to change the ASCII Offset to NULL.</p> <p>Select <b>SPACE</b> to change the ASCII Offset to SPACE.  <b>Note:</b> This is the default for Track 1.</p>	<p>Select <b>ZERO</b> to change the ASCII Offset to ZERO.  <b>Note:</b> This is the default for Tracks 2 and 3.</p>
	<p>Select <b>75 BPI</b> to change the bits per inch to 75 BPI.  <b>Note:</b> This is the default for Track 2.</p> <p>Select <b>128 BPI</b> to change the bits per inch to 128 BPI.</p>	<p>Select <b>210 BPI</b> to change the bits per inch to 210 BPI.  <b>Note:</b> This is the default for Tracks 1 and 3.</p> <p>Select <b>Custom BPI</b>, which enables the custom BPI text box.  <b>Note:</b> The lower limit is 75 and upper limit is 210.</p>
	<p>Select <b>No LRC</b> to change the LRC Generation to none.</p> <p>Select <b>Even Parity</b> to change the LRC Generation to Even Parity.  <b>Note:</b> This is the default for all tracks.</p>	<p>Select <b>Odd Parity</b> to change the LRC Generation to Odd Parity.</p>
	<p>Select <b>No Parity</b> to change the Character Parity to none.</p> <p>Select <b>Even Parity</b> to change the Character Parity to Even Parity.</p>	<p>Select <b>Odd Parity</b> to change the Character Parity to Odd Parity.  <b>Note:</b> This is the default for all tracks.</p>



Window TAB	Procedure	Procedure (continued)
<input type="checkbox"/> Reverse Bit Order <input type="checkbox"/> Add Leading Zeros	<b>Reverse Bit Order</b> is used to reverse the character bits and is used for the encryption of data in specific programs	<b>Add Leading Zeros</b> is used to add a set number of leading zeros to the magnetic string in order to move the starting point of the encoded data in specific programs for encryption of data.

#### 4.11.2 Magnetic Track Options

The magnetic Encoding Module encodes onto tracks in accordance with an ISO 7811-2 Magnetic Stripe. For track locations, review the display below. Tabs are available on the **Magnetic Encoding** tab with options for encoding data on each track.

##### Reviewing the ISO Track Locations

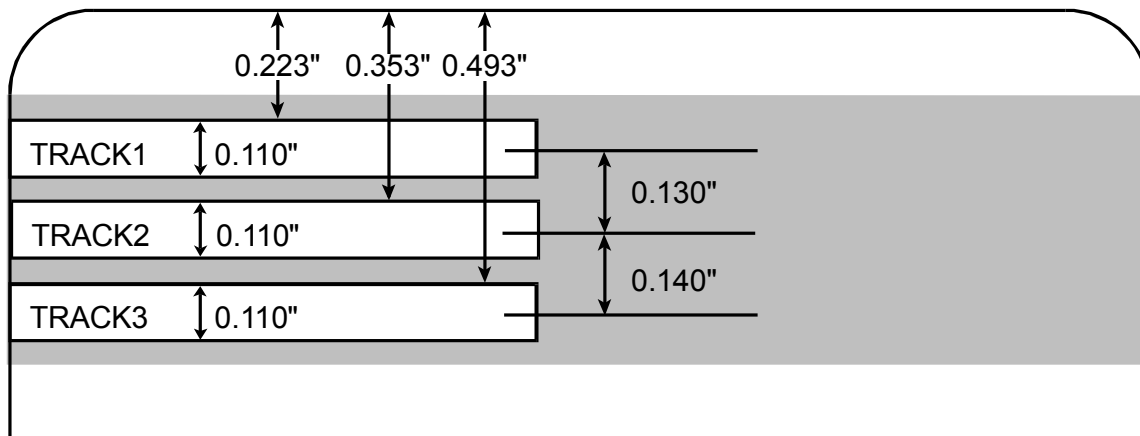

##### Reviewing the Sample String

- Track 1: ~1%JULIEANDERSON^1234567890?
- Track 2: ~2;1234567890987654321?
- Track 3: ~3;1234567890987654321?

Track	Start Sentinel	End Sentinel	Field Separator	Valid Characters	Maximum Number of Characters
<b>Track 1</b>	%	?	^	ASCII 32-95 (See the table below.)	78
<b>Track 2</b>	;	?	=	ASCII 48-63 (See the table below.)	39
<b>Track 3</b>	;	?	=	ASCII 48-63 (See the table below.)	106

## Sending the Track Data

Magnetic track data is sent in the form of text strings from the application software to the Printer Driver.

- In order for the Printer Driver to differentiate between Magnetic Track data and the rest of the printable objects, specific characters must be added to the magnetic data to be encoded.
- These specify the data that is to be encoded, the tracks to encode and mark the start and stop of the data string. In some cases, these specific characters are automatically added to the string of track data by ID software applications.
- In most cases, the user must carefully add these characters to the string of Magnetic Track data. If these characters are not added to the track data, the text intended for the Magnetic Track will appear as printed text on the card. To avoid this, track information must be entered as described below.

When entering track data, the ~ (tilde) character is entered first, followed by the track number (1, 2 or 3) on which the data should encode. The data to be encoded follows the track number.

The first character of this data string must be the track's specific Start Sentinel (SS) and the last character must be the specific End Sentinel (ES).

The characters or data in between the SS and ES can include all of the valid characters specific to each track.

The number of these characters, however, is limited by each track's maximum character capacity.

When segmenting track data, the appropriate Field Separator (FS) must be used. The table below shows the SS, ES, FS and the valid characters defined for each track.

### Reviewing the ASCII Code and Character Table

ASCII Code	Character	ASCII Code	Character	ASCII Code	Character
32	space	56	8	80	P
33	!	57	9	81	Q
34		58	:	82	R
35	#	59	;	83	S
36	\$	60	<	84	T
37	%	61	=	85	U
38	and	62	>	86	V
39	'	63	?	87	W
40	(	64	@	88	X
41	)	65	A	89	Y
42	*	66	B	90	Z
43	+	67	C	91	[
44	'	68	D	92	\
45	-	69	E	93	]
46	.	70	F	94	^
47	/	71	G	95	_
48	0	72	H		
49	1	73	I		
50	2	74	J		
51	3	75	K		
52	4	76	L		
53	5	77	M		
54	6	78	N		
55	7	79	O		



## 4.12 Overlay / Print Area

Use the **Overlay / Print Area** tab to control and customize where the Overlay (O) panel and/or the print area appear on the card. By default, this option is set to print and overlay the entire card.

The orientation of the card display area is determined by the orientation specified in your template.

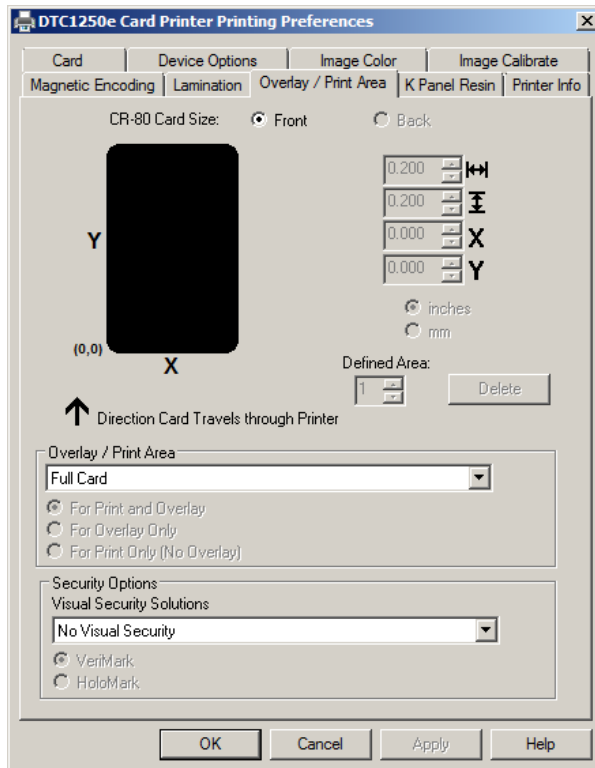

### 4.12.1 Defining an Overlay or Print Area

To define an overlay or print area:

1. Click the **Front** or **Back** radio button to specify the side of the card to apply the area definition.
2. Click the drop down button in the **Overlay / Print Area** field and select the option that serves your purpose:
  - **Full Card** – Select this option to overlay and/or print the entire card.
  - **Defined Area(s)** – Select this option to overlay and/or print only in the selected and definea area(s).
  - **Undefined Area(s)** – Select this option to overlay and/or print in the space outside the selected and defined area.
  - **Omit Smart Chip Area** – Select this option to overlay and/or print only in the space outside the standard location of a smart chip.
  - **Omit Mag Strip Area** – Select this option to overlay and/or print only in the space outside the standard location of an ISO-standard magnetic stripe.

- **Omit Signature Area** – Select this option to overlay and/or print only in the space outside the standard location of a signature panel.

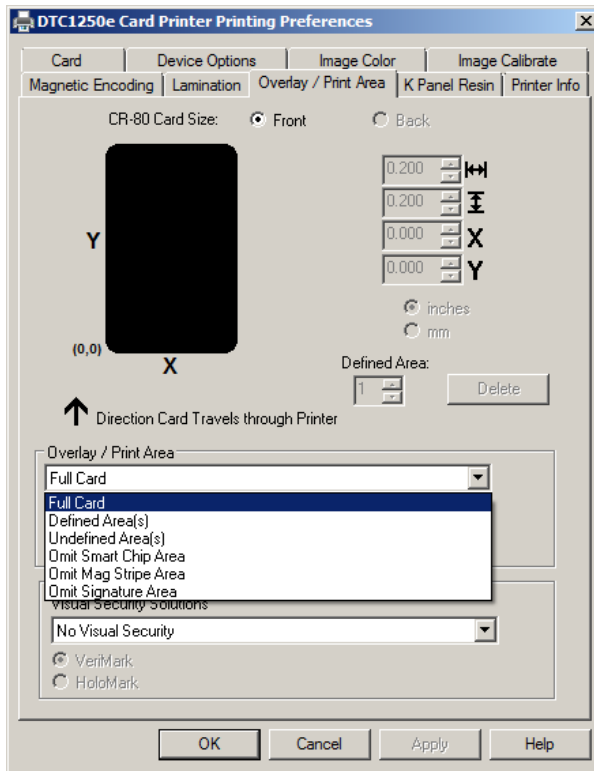

- When you select an option, a default blacked area appears on the card design area grid.

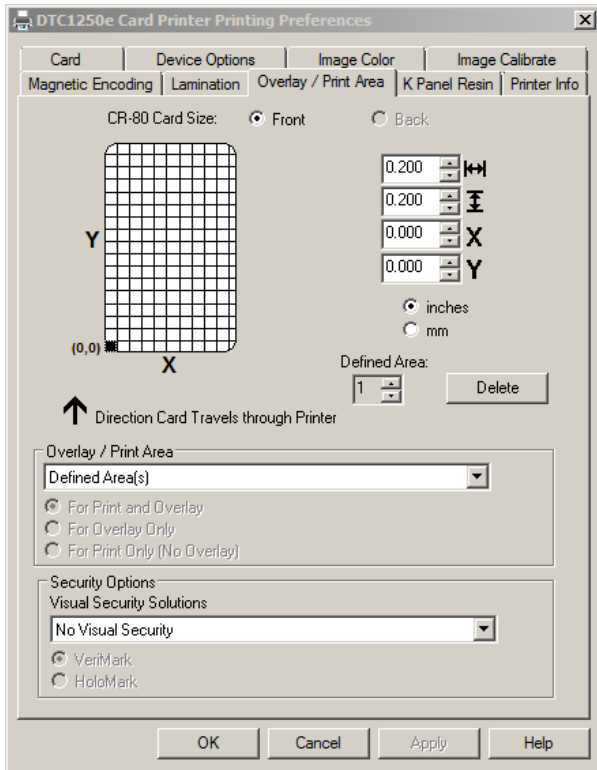

- Click and drag to enlarge the area and move it to the preferred location on the card. The size and coordinates of the area update in the number fields using the units you specify, inches or mm.

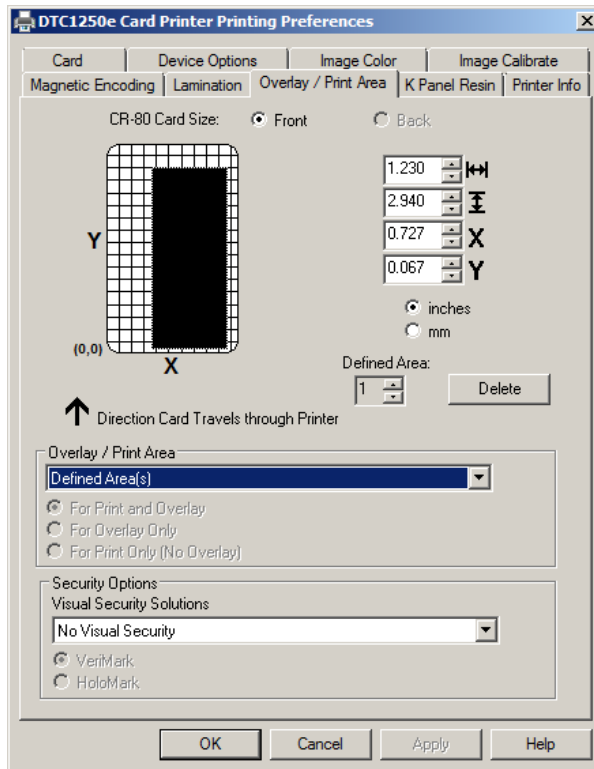

#### 4.12.2 Overlay / Print Area

The **Overlay / Print Area** box includes several options:

- **Defined Area** – To define multiple areas, increase the count in the Defined Area field and repeat the overlay or print area definition steps (above).
- **For Print and Overlay** – This option applies the defined area to both the print and overlay processes.
- **For Overlay Only** – The defined area applies only to the overlay process. The entire card prints and only the overlay is affected.
- **For Print Only (No Overlay)** – The defined area applies only to the print process. Overlay is disabled.

#### 4.12.3 Security Options

The Security Options area includes the following options:

- **Visual Security Solutions** – Use this field to enable and select a visual security option. When one of the options is selected, the **Overlay/Print Area** feature is disabled.

This field presents options based on the orientation of the card in the template. The default value for all cards is **No Visual Security**. Landscape designs offer:

- **A** – Upper Left
- **B** – Upper Right
- **C** – Lower Left
- **D** – Lower Right
- Portrait designs offer:
  - **E** – Upper Left
  - **F** – Upper Right
  - **G** – Lower Left
- **HoloMark** – Use this option for hologram security.

## 4.13 K Panel Resin

Use this tab to control where the resin black (K) Panel of a full-color ribbon is printed. If a ribbon without a K resin panel is installed in your printer, these options are grayed out and unavailable.

The orientation of the card display area is determined by the orientation specified in your template.

Refer to **Defining an Overlay or Print Area** for information that relates to this tab.

The **K Panel Resin** tab includes the **Print All Black with K Panel** area and options to **Print YMC under K** or **Print K Only**.

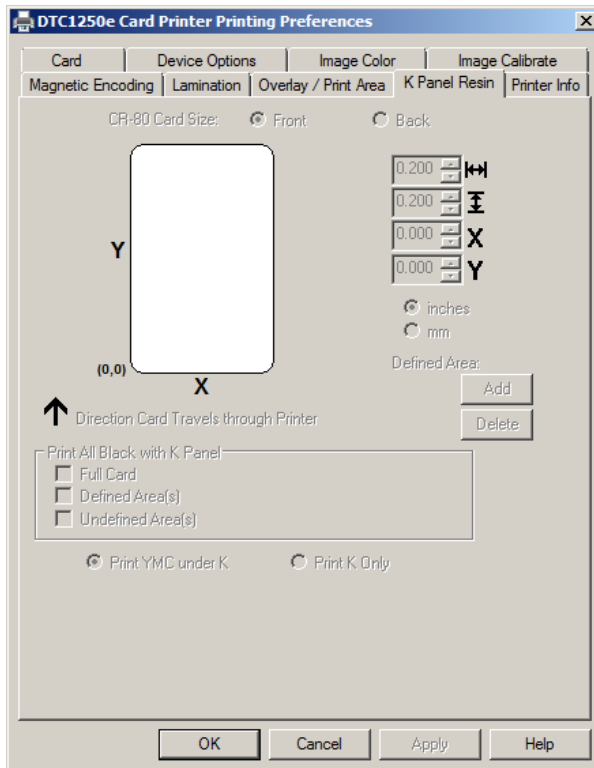

### 4.13.1 Print All Black with K Panel

This area includes three options:

- **Full Card** – Select this option to overlay and/or print the entire card.
- **Defined Area(s)** – Select this option to overlay and/or print only in the selected and define area(s).
- **Undefined Area(s)** – Select this option to overlay and/or print in the space outside the selected and defined area.

### 4.13.2 Print YMC under K

Select **Print YMC under K** to print all black in the designated areas with the yellow (Y), magenta (M) and cyan (C) ribbon panels directly beneath the resin black (K) panel. This combination provides a gradual transition between the resin black text or bar code.

### 4.13.3 Print K Only

Select **Print K Only** to print using the resin black (K) panel onto a white background to maximize the sharpness of printed text and bar codes.

## 4.14 Printer Info

Use the options on this tab to view information about the medias installed on the printer:

- Ribbon
- Card Count
- Printer Serial #
- Firmware Version
- Reorder Number

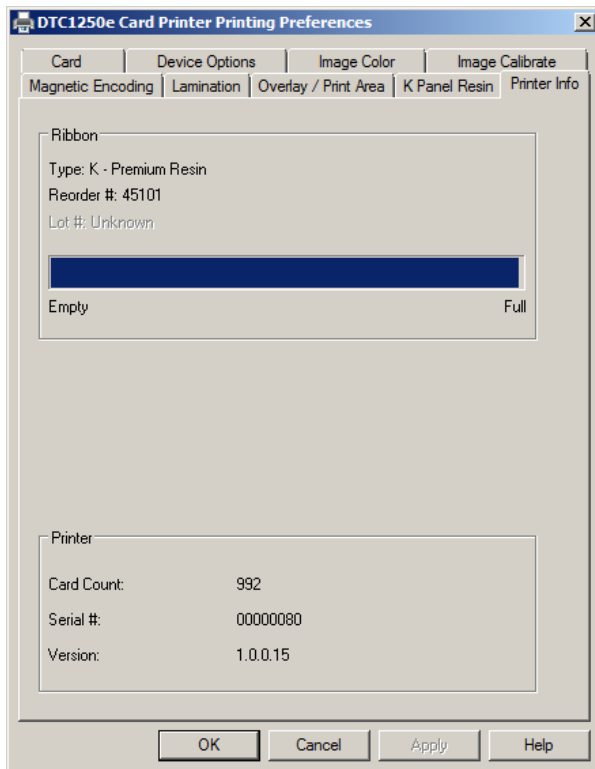

## 5 System Overview - Troubleshooting

### Sequence of Operations

Knowing the sequence of the printer operation helps when troubleshooting the printer.

Step	Process
1	File information is received from the PC.
2	Printer compares the installed ribbon type stored in memory with the ribbon type command that was sent from the printer. If the ribbon type does not match, the <b>Pause</b> button (on the right) flashes.
3	The print stepper motor engages.
4	The card feed sensor detects the leading edge of the card and the headlift stepper engages to disengage the input lever.
5	The card feeds through for the alignment pass.
6	The card feed stepper motor engages to queue card for magnetic encoding (if applicable).
7	The encoded data is written to the card (if applicable).
8	The magnetic encoder verifies while the stepper reverses the card (if applicable).
9	The print ribbon drive engages (if not already at the yellow panel).
10	The print ribbon sensor looks for the yellow panel. <b>Note:</b> The print ribbon encoder detects the number of revolutions required to use an entire color panel.
11	The print stepper motor engages.
12	The card feed sensor detects the leading edge of card.
13	The print stepper motor queues card to the middle of the platen roller. All stop.
14	The print headlift motor engages to the print position.
15	The print cover sensor checks for closed state.
16	The print stepper motor engages.
17	The ribbon drive motor engages.
18	The image data is burned by the printhead until the image data is depleted. All Stop.
19	The thermistor engages the printhead cooling fan to maintain proper operating temperature.
20	The headlift motor engages to the queue position.
21	The print stepper motor engages.
22	The print ribbon drive engages.
23	After ribbon advances a few encoder clicks, assume the ribbon is free of card. All stop.
24	Repeat Steps 9 through 22 for the appropriate number of color/overlay Panels.
25	Either the card is ejected from the singled-sided printer or the card feed stepper engages to queue the card for the flipper table for the dual-sided printer.
26	All stop.





## 5.1 Troubleshooting

### 5.1.1 Printer Error Buttons







The DTC1250e and DTC4250e use button messages rather than a display message system.



All Printers have two (2) buttons:

- ON/OFF 
- Pause 

The display message system appears as a graphical message, for example:



Step	Procedure
1	The <b>ON/OFF</b> (  ) button is blue when the printer is ON. When the printer enters the Sleep mode, the button LED is dimmed but still ON.
2	The <b>Pause</b> (  ) button illuminates blue when the printer is capable of accepting a print job and is not in an error state. This button LED will continue to stay on while the printer prints as long as there is no error. This button LED will also be dimmed when the printer goes into Sleep mode.
3	When an error occurs, the <b>Pause</b> (  ) button no longer illuminates blue but blinks red.
4	Press the <b>ON/OFF</b> (  ) button when printer is in an error state to cause the action to be cancelled. <b>Note:</b> If no other error occurs, the <b>Pause</b> button illuminates as blue.
5	Press the <b>Pause</b> (  ) button when printer is in an error state to cause the printer to retry. <b>Note:</b> The button illuminates as blue and retries the failed action.
6	When downloading an upgrade file, both buttons are blue and blink. If the unit is a DTC1250E, you are notified that the upgrade is in process.
7	<b>DTC4250E:</b> If a language (other than English) is currently selected, you can press and hold the <b>Pause</b> (  ) button during the power-up sequence to change the language back to English.

Step	Procedure
8	<p><b>DTC1250E:</b> When no printer display is available, press or hold the buttons to access some internal tests.</p> <ul style="list-style-type: none"> <li>To print a card with the Printer Settings, press the <b>Pause</b> (  ) button and hold for 4+ seconds when the printer is ready and idle.</li> <li>To print the Alignment or the Self Test, press and hold the <b>Pause</b> (  ) button during the power-up sequence</li> </ul>

### 5.1.2 Error Messages

This section provides the troubleshooting table for the error message. The DTC4250E has a display that shows the printer error messages.

- When an error occurs in the printer, the PC shows the error message on screen with solutions.
- The display blinks in the location requiring attention. Locations can include the printer, input hopper, magnetic encoder, flipper, card path, ribbon, and data/communication device error.

Each table uses a 3-column presentation to display a specific or printer error message, its cause and its solution.

- This format allows the troubleshooter to identify the error and its cause, and then perform the procedure provided in the solution column.
- This standard mode of identifying the problem and its solution should provide an efficient method of troubleshooting this printer.
- If you encounter problems beyond the capabilities of this error message table, you should contact Technical Support..

Error Message	Cause	Solution
# 81 Unable to Feed	The printer is unable to feed a card from the input card hopper.	<p>Check the following, then press the <b>Pause</b> button to continue.</p> <ul style="list-style-type: none"> <li>Verify the card thickness setting is set to the thickness of your cards.</li> <li>Verify the Cleaning roller is properly installed on the Ribbon Cartridge.</li> <li>Check for card slippage. If necessary, run the Printer cleaning routine.</li> <li>Verify that your cards are within the accepted card size range.</li> <li>Verify the cards are not sticking together.</li> </ul>

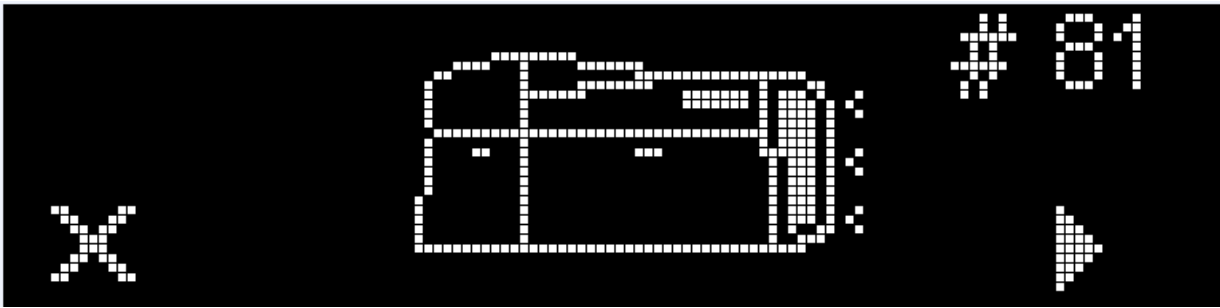

### 5.1.3 Troubleshooting with the Error Message Table

Error Message	Cause	Solution
# 2 Head Move Error	The printhead lift has malfunctioned.	Reset the printer and try again. If this problem persists, call for technical assistance.
# 8 Head Sensor Error	The printhead temperature sensor is not functioning or is not connected properly. Or, the printhead is not cooling properly.	Reset the printer and try again. If the problem persists, call for technical assistance.
# 9 Reboot Required	An unspecified system error has been detected by the printer firmware.	Reset the printer and try again. If this problem persists, call for technical assistance.
# 25 Ribbon not Installed	No ribbon is installed in the printer.	Install a ribbon and retry.
# 30 Mag Verify Error	Magnetic encoding verification has failed.	Try encoding with a different card. Verify cards have the magnetic stripe. Replace the magnetic encoding module.
# 31 No Mag Module	The printer is not configured with the encoder data type that you are trying to send.	Ensure that no encoding data is being sent with the print job and reprint the card. Install a magnetic encoding module.
# 38 # 39 # 40 EEPROM Corrupt EEPROM Read Error	EEPROM is restored with factory default values.	If changes were made in the Advanced Settings tab in the printer driver, click the Default button to reset these numbers. Reset the printer and try again. If this problem persists, call for technical assistance.

Error Message	Cause	Solution
# 44 Flipper Jam/ Home Error	A card has become jammed in the printer's flipper table. The flipper failed to position properly while aligning a card or flipping a card.	<ul style="list-style-type: none"> <li>Clear any cards in the flippertable using the buttons to move the card out. Resume printing.</li> <li>The flipper table should be level when the printer is powered up. If the flipper Table is at an angle, open the card output door and manually level it. Then cycle the printer power to reset.</li> <li>Reset the printer and retry. If problem persists call for technical assistance.</li> </ul>
# 45 No Flip Module installed	Request to print on 2 <sup>nd</sup> side of card, but no flipper is installed.	If a Flipper Module is present, ensure that the Print Both Sides option in the printer driver is set correctly. Install a flipper module.
# 64 # 65 # 66 Reboot Required	Unspecified system error detected by the printer firmware.	Reset the printer and try again. If this problem persists, call for technical assistance.
# 68 Card in Printer	A card is jammed in the print station or card flipping area of the Printer.	Clear the jam and press the <b>Pause</b> button.
# 70 Multiple Feed	Multiple cards were fed into the printer.	Verify the card thickness is set to the thickness of your cards, then press the <b>Pause</b> button. Check for card slippage. If necessary, run the printer cleaning routine Verify the cleaning roller is properly installed on the ribbon cartridge. Verify the cards are not sticking together.
# 81 Unable to Feed	The printer is unable to feed a card from the input card hopper.	Check the following, then press the <b>Pause</b> button to continue. Verify the card thickness setting is set to the thickness of your cards. Verify the Cleaning roller is properly installed on the Ribbon Cartridge. Check for card slippage. If necessary, run the Printer cleaning routine. Verify that your cards are within the perimeters accepted card size range. Verify the cards are not sticking together.
# 82 Mag Jam	A card is jammed magnetic station	Clear any cards in the magnetic station using the buttons to move the card out. Press the <b>Pause</b> button to continue.

Error Message	Cause	Solution
# 91 Ribbon Out	The print ribbon has run out.	Install a new ribbon. Press the <b>Pause</b> button to continue or the ON/OFF button to cancel.
# 93 Wrong Ribbon	The print ribbon installed in the printer does not match the ribbon type selected in the printer driver.	Change either the installed print ribbon or the ribbon type selected in the printer driver. Press the <b>Pause</b> button to continue or the ON/OFF button to cancel.
# 97 Ribbon Search Error	The ribbon is not able to find the next panel correctly. Check for jams/breaks.	Recalibrate the ribbon sensor. If broken, repair by taping the ribbon back on to the take- up core. Replace the ribbon. Press the <b>Pause</b> button to continue or the ON/OFF button to cancel.
# 99 Ribbon Error	The print ribbon has either broken or jammed.	If jammed, clear the jam. If broken, repair by taping the ribbon back on to the take- up core. Press the <b>Pause</b> button to continue or the ON/OFF button to cancel.
# 100 Ribbon RFID Error	There is no ribbon or the ribbon tag information is corrupted or incorrect.	Verify the printer driver settings for correct Ribbon. Try a new ribbon and continue. Press the ON/OFF button to cancel.
# 102 # 103 # 104 #3 Headlift Error	This is a problem with the printhead Lift.	Reset the printer and try again. If this problem persists, call for technical assistance.
# 106 Job Data Error	The print data sent to the printer is corrupt or has been interrupted.	Check the interface cable. Select the ON/OFF button to cancel this print job and then resend the job.
# 107 Printing Error	An error was detected during printing.	Reset the printer and try again. If this problem persists, call for technical assistance.
# 109 # 113 Ribbon Release Error	The printer cannot locate the next ribbon panel in order to release the ribbon from the card.	Ensure that the ribbon is not stuck to the card. Replace the ribbon. Recalibrate the ribbon sensor. If the ribbon is broken, repair by taping the ribbon back onto the take- up core and manually advance to the next panel. Press the Pause button to continue.
# 110 Card Jam/Align error	A card is jammed in the print station or card flipping area of the printer.	Clear the jam. Press the <b>Pause</b> button to continue.

Error Message	Cause	Solution
# 111 Head Loading	An unrecoverable error has occurred during printing.	Reset the printer and try again. If this problem persists, call for technical assistance.
# 112 Card Jam/Align error	A card is jammed in the print station or card flipping area of the Printer.	Clear the jam. Press the <b>Pause</b> button to continue.
# 128 # 170 Calibrate Ribbon	The print ribbon sensor is out of calibration or has failed.	Calibrate the ribbon sensor. Check for material blocking sensor and try again.
# 131 Flipper Jam/Home Error	A card has become jammed in the printer's flipper table. The flipper failed to position properly while aligning a card or flipping a card.	Clear any cards in the flipper table, using the buttons to move the card out. Resume printing. Reset the printer and retry. If problem persists call for technical assistance.
# 136 Secure Guard Print Disabled	Printing is disabled by SecureGuard until a password is received.	Reset the printer and retry. If the problem persists, call for technical assistance.
# 139 Please Remove Ribbon	Ribbon needs to be removed.	Reset the printer and retry. If problem persists, call for technical assistance.
# 144 EEPROM Corrupt EEPROM Read Error	EEPROM restored with factory default values.	If changes were made in the <b>Advanced Setting</b> tab in the printer driver, click the <b>Default</b> button to reset these numbers. Reset the printer and try again. If this problem persists, call for technical assistance.
#202 Encoder not installed	You are trying to send encoding data, but the Printer is not configured with this Encoder type. iCLASS, Prox, Mifare, SmartCard	Ensure that no encoding data is being sent with the print job and reprint the card. Install an encoding module.

**5.1.4 Printer-Specific Tools (DTC1250E, DTC4250E)**

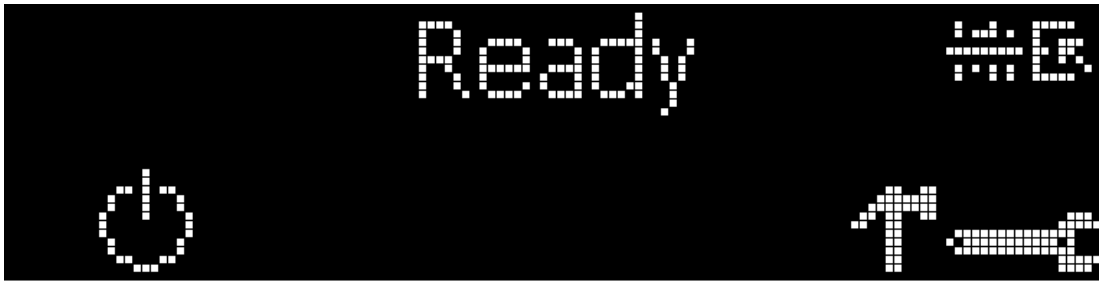

The status icons are as follows:

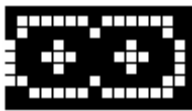

This icon indicates that the print ribbon supply is low and will require replacement soon. For the DTC1250E and DTC4250E models, the entire ribbon cartridge must be replaced.



This icon indicates that the printer needs to be cleaned.



This icon is only displayed for printers with an attached dual-input card hopper and indicates that the top input hopper is currently selected.



This icon is only displayed for printers with an attached dual-input card hopper and indicates that the bottom input hopper is currently selected.

Press the  button to scroll through the details of the printer and perform the action.

Press the  button to select the option.

When  is selected, use the left down arrow  to scroll through the Info, Test Prints, and Languages and Exit.

Use the corner arrow  to run that option.

The curved arrow  will return to the first screen.

#### 5.1.4.1 Additional Printer Specific Tools

Label	Description
INFO	<ul style="list-style-type: none"> <li>• Printer Type</li> <li>• Firmware Version</li> <li>• IP Address</li> <li>• Flipper</li> <li>• Lamination</li> <li>• Magnetics</li> <li>• E-Card</li> <li>• Password</li> <li>• Card count</li> </ul>
TEST PRINTS	<p><b>Color Photo:</b> Select this to print a color card to test communication and integrity.</p> <p><b>Alignment:</b> Select this to print a card used to align the print image on the card.</p> <p><b>Settings:</b> Select this to print a card with the Advanced settings.</p> <p><b>Resin:</b> Select this to print a RESIN test card.</p> <p><b>Rewritable:</b> Select this to ERASE the Rewritable card.</p> <p><b>Magnetic:</b> Select this to test Magnetic encoding. (Hi-Co only)</p> <p><b>Lamination:</b> Select this to laminate a test card.</p>



Label	Description
<b>Hopper Select</b>	Ability to select which hopper to feed cards from. Applies to Dual Hopper Printers.
<b>Toolbox</b>	<p><b>Clean Printer:</b> Select this to run the clean printer routine.</p> <p><b>Clean Laminator:</b> Select this to run the clean laminator routine.</p> <p><b>Calibrate Mag:</b> Select this to calibrate the Magnetic Sensor</p> <p><b>Calibrate Rib Sensor:</b> Select this to calibrate the ribbon sensor.</p> <p><b>Network:</b> Select this to configure network options.</p>
<b>Language</b>	<p><b>Language:</b> Select this choice to change the Printer Displayed Language.</p>
<b>Exit</b>	<p><b>Exit:</b> Select this choice to exit the Printer Tool options.</p>

## 6 Firmware Upgrades

### Upgrade the Printer Firmware

Step	Procedure
1	Requirements <ul style="list-style-type: none"> <li>• Internet access</li> <li>• Printer powered up and connected to PC</li> </ul>
2	Open the FARGO Workbench Printer Utility or use the <b>Diagnostics</b> button from the <b>Card</b> tab of the <b>Printing Preference</b> page. <b>Note:</b> Workbench is also available from the FARGO Folder in the Windows Program folder. <div data-bbox="404 674 1170 1625" style="border: 1px solid black; padding: 10px; margin: 10px 0;"> <p>The screenshot shows the 'Card' tab of the FARGO Workbench Printer Utility. The 'Card' tab is highlighted with a black box. The 'Diagnostics' button is also highlighted with a black box. The interface includes a 'Card Size' section with a dropdown menu set to 'CR-80', radio buttons for 'inches' (selected) and 'mm', and fields for 'Print Width: 2.114', 'Print Length: 3.362', and 'Card Thickness: 30'. Below this is an 'Orientation' section with 'Portrait' (selected) and 'Landscape' options. There are also 'Copies' and 'Card Hopper Selection' dropdowns. At the bottom, there are buttons for 'Diagnostics', 'Test Print', 'ToolBox', and 'About', along with standard 'OK', 'Cancel', 'Apply', and 'Help' buttons.</p> </div>

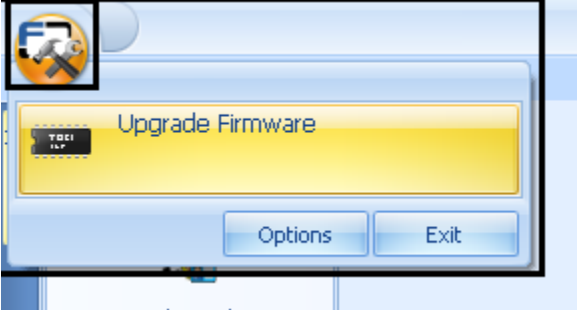
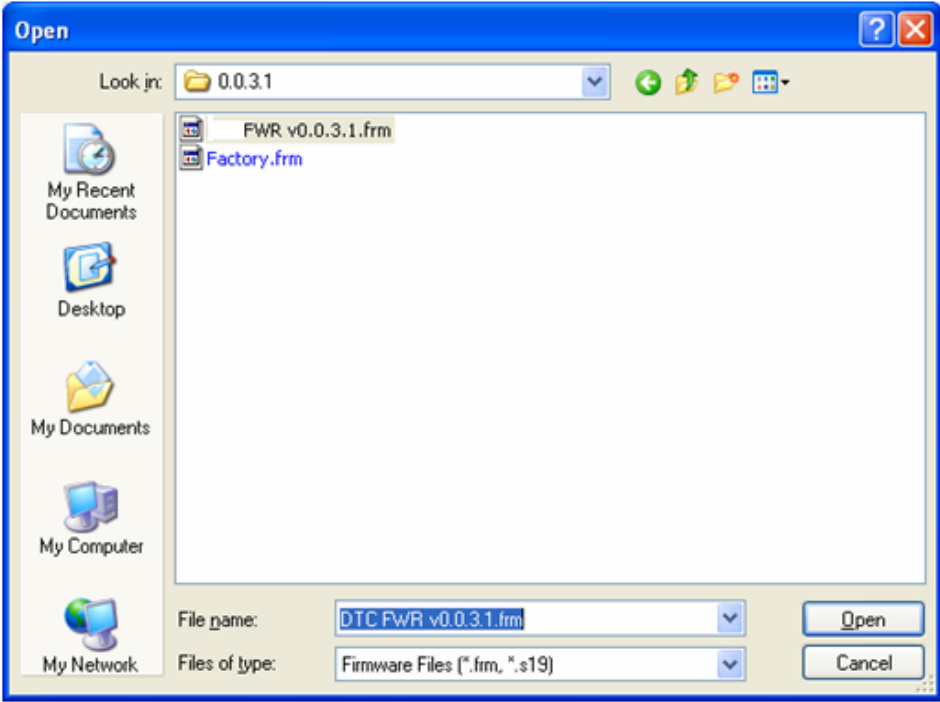
Step	Procedure
3	<p>From the <b>Application Icon</b>, select <b>Upgrade Firmware</b>.</p> 
4	<p>Find the Firmware via <b>Check for Firmware Updates</b> at <a href="http://www.hidglobal.com">www.hidglobal.com</a>.</p> <ul style="list-style-type: none"> <li>• Save the file to a folder. (Double-click the file to unzip the file.)</li> <li>• Use the <b>Browse</b> button to find the .frm file.</li> <li>• Select the file and click <b>Open</b>.</li> </ul> 
5	Click <b>Upgrade</b> to start the upgrade process.
6	The <b>LOADING FIRMWARE</b> message displays while the Firmware is updating.
7	Reboot the printer if it does not reboot automatically.

## 7 Technical Support

This section provides you with an efficient, step-by-step procedure to be used when contacting HID GLOBAL Technical Support, as needed, for this card printer.

Step	Procedure
1	Contact the HID Global Technical Support Group by phone at (866)607-7339 Ext #6 or by fax at (952) 946-8492 for additional technical assistance. <b>OR</b> Contact HID Technical Support.
2	Position a phone near the printer and computer so the Technician can help to troubleshoot the printer.
3	Please have a self-test and a sample card ready when calling HID Technical Support.

### 7.1 Reading the Serial Numbers on a FARGO Printer

You can determine when your card Printer was manufactured by reading directly from the serial number (affixed to your card printer).

Example	Explanation
Reviewing Example No. 2: Serial Number B2050028 (2012)	<ul style="list-style-type: none"> <li>• <b>B2050028:</b> The first two digits in the serial number indicate the year the printer was built (e.g., the digits B2 indicate the year 2012).</li> <li>• <b>B2050028:</b> The third and fourth digits in the serial number indicate the week the printer was built (e.g., the digits 05 indicate week 5 of that year).</li> <li>• <b>B2050028:</b> The last four digits indicate the sequence number for the numeric order in which the printers were built.</li> </ul>

## 8 Appendix A

### Selecting the Fluorescent Panel Ribbon Type (DTC4250e only)

Fluorescent dye color is bright when black light is applied to it. The YMCFKO/YMCFKOK ribbon is an economical way to add a fully customizable, incremental level of security to your photo identification cards.

This process allows you to configure the data that is printed with the fluorescent panel of an YMCFKO/YMCFKOK Ribbon.

**Note:** Any software program may be used to print the special florescent panel of the Ribbon to a card once the driver and Workbench are set up correctly.

These ribbons contain a yellow (Y), magenta (M), cyan (C), and resin black (K) panels to create a full color over-the-edge printing identification card. In addition, the ribbon contains a dye-based fluorescing panel (F) which will allow you to print a standard or one-to-one personalized fluorescing image that is completely invisible until exposed to ultraviolet light.

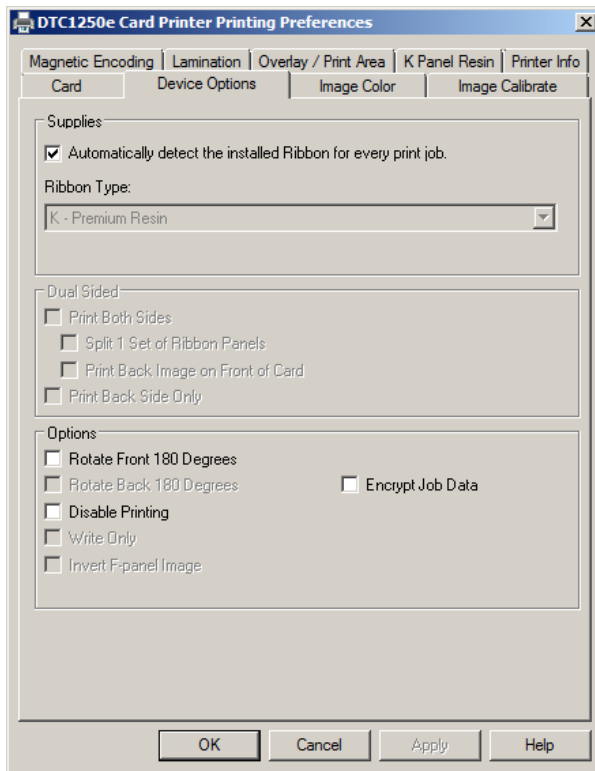

Check Invert F-Panel Image to create a negative of the fluorescent image. This option refers to the ability to cause light or white areas of the image to fluoresce and for dark colors to remain dark on the printed card when exposed to an ultraviolet light. By default, the dark areas of the image fluoresce on the card. Lighter or white areas have no dye applied.

### 8.1.1 Creating a Custom Fluorescent Image using the YMCFKO Ribbon



There are three methods used to accomplish the creation of a custom fluorescent image when using the YMCFKO Ribbon.

- **Printer Driver Method:** The fluorescent panel image can be configured directly from the badge application software.  
**Note:** You can now print a unique fluorescent image, such as the card holder's picture on each card.
- **Asure ID Method:** This method is described in the **Asure ID Software User Guide**. See the procedure relating to the Fluorescent Panel Ribbon. For more information about , please visit the HID Global support website.
- **Workbench Method:** This method is described in the **Workbench User Guide** and the **Help** facility. See the User Guide on your CD. For Help, enter Workbench by clicking the **Diagnostics** button from the **Card** tab of the **Printing Preferences** page and select **Help**.

### 8.1.2 Configuring Fluorescent Data using the Application

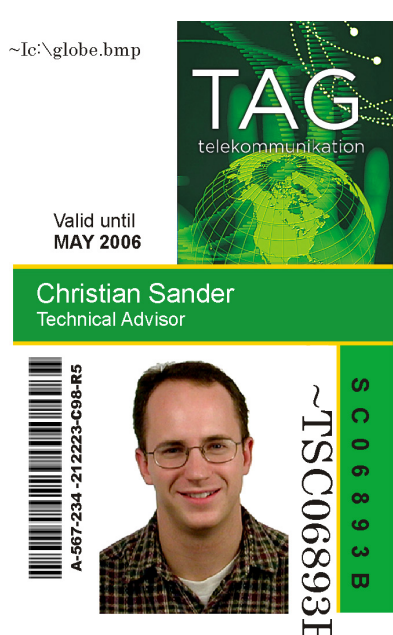
This process creates a fluorescent image on your card using a simple text string command in your badge application.

Step	Procedure
1	<b>Creating Fluorescent Text:</b> Create a new text box in your badge application.
2	Type the <b>TEXT</b> that you want to appear as fluorescent and put a <b>~T</b> before the start of the text with no space after the <b>~T</b> . The text will start on the card where the <b>~T</b> begins.  

Step	Procedure
3	<p><b>Creating a Fluorescent Image:</b> In a separate drawing program, create the image that you wish to fluoresce.</p> 
4	<p>Create the <b>IMAGE</b> in the actual size that you want it to appear on the card, and save it as a Grayscale or 1 - bit bmp file on the root c:\ directory.</p> <ul style="list-style-type: none"> <li>Do not put spaces in the file name.</li> </ul>
5	<p>Create a new text box in your badge application, and type ~I followed by the address of your image (see Display A below). The top left of your image will start at the top left of your text box.</p>
6	<p>Set up the printer driver preferences. Refer to Step 8-9 below.</p>
7	<p>Printer will print the fluorescent BMP IMAGE at the ~I position on the card. Printer will print the fluorescent TEXT at the ~T position on the card.</p> <p><b>BMP Image located at c:\globe.bmp</b></p> 
8	<p>Set the Ribbon for YMCFKO in the Printing Preferences.</p> <p><b>Note:</b> The <b>Automatically detect the installed Ribbon for every print job</b> button may also be used.</p>

Step	Procedure
9	<p data-bbox="391 296 1312 321">Check <b>Invert F-Panel Image</b> to create a negative of the fluorescent image. See below.</p> <ul data-bbox="391 327 1312 443" style="list-style-type: none"><li data-bbox="391 327 1312 384">• This refers to the ability to cause light or white areas of the image to fluoresce and dark colors to remain dark on the printed card when exposed to a UV light.</li><li data-bbox="391 390 1312 443">• This was requested because the fluorescent dye color is bright when black light is applied to it.</li></ul> <p data-bbox="391 449 1325 506">By default, the dark areas of the image will fluoresce on the card and the lighter or white areas will have no dye applied.</p> <p data-bbox="391 512 1192 529"><b>Note:</b> This may improve the look of the person's image if used for the Logo.</p>



**HID Global Headquarters:**

**North America: +1 949 732 2000**

**Toll Free: 1 800 237 7769**

**Europe, Middle East, Africa: +49 6123 791 0**

**Asia Pacific: +852 3160 9800**

**Latin America: +52 477 779 1492**

**[support.hidglobal.com](https://support.hidglobal.com)**

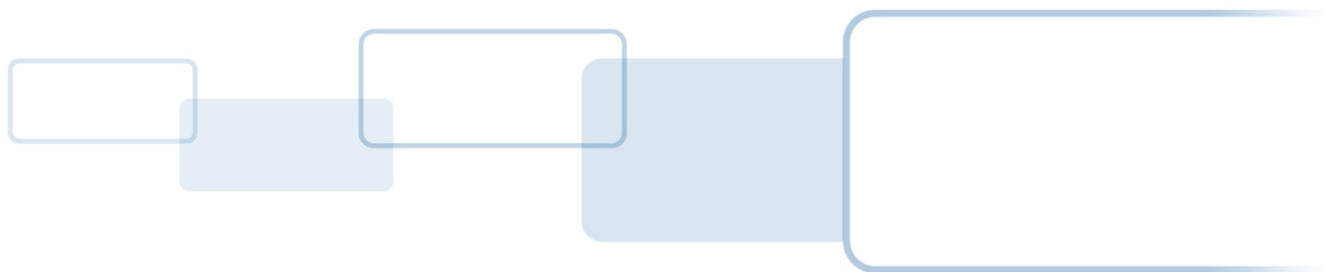

**[hidglobal.com](https://hidglobal.com)**