



## **DTC400e/Persona® C30e/M30e Card Printer User Guide (Rev. 1.1)**

- **Single-side Model**
- **Dual-side Model**
- **Single-side (plus Mag) Model**
- **Dual-side (plus Mag) Model**

**Part Number:** L001364 (user guide)

DTC400e/Persona C30e/M30e Card Printer User Guide (Rev. 1.1), property of Fargo Electronics, Incorporated

Copyright © 2008 by Fargo Electronics, Incorporated. All rights reserved. Printed in the United States of America. Exclusive permission is granted to authorized resellers of Fargo products to reproduce and distribute this copyrighted document to authorized Fargo customers, who have signed a “no disclosure agreement” regarding the restricted, proprietary use of said document.

The revision number for this document will be updated to reflect changes, corrections, updates and enhancements to this document.

Revision Control Number	Date	Document Title
Revision 1.1	November 2009	DTC400e/Persona C30e/M30e Card Printer User Guide Added 64 bit support
Revision 1.0	February 2009	DTC400e/Persona C30e/M30e Card Printer User Guide

These reference documents were thoroughly reviewed to provide Fargo with professional and international standards, requirements, guidelines and models for our technical, training and user documentation. At all times, the *Copyright Protection Notice* for each document was adhered to within our Fargo documentation process. This reference to other documents does not imply that Fargo is an ISO-certified company at this time.

ANSI/ISO/ASQ Q9001-2000 American National Standard, (sub-title) Quality Management Systems - Requirements (published by the American Society of Quality, Quality Press, P.O. Box 3005, Milwaukee, Wisconsin 53201-3005)

The ASQ ISO 9000:2000 Handbook (editors, Charles A. Cianfrani, Joseph J. Tsiakals and John E. West; Second Edition; published by the American Society of Quality, Quality Press, 600 N. Plankinton Avenue, Milwaukee, Wisconsin 53203)

Juran's Quality Handbook (editors, Joseph M. Juran and A. Blanton Godfrey; Fifth Edition, McGraw-Hill)

Any questions regarding changes, corrections, updates or enhancements to this document should be forwarded to:

Support Services  
6533 Flying Cloud Drive  
Eden Prairie, MN 55344 (USA)  
(952) 941-0050  
FAX: (952) 946-8492  
[www.fargosupport.com](http://www.fargosupport.com)

# Table of Contents

<b>Section 1: Introduction</b>	<b>1-1</b>
How to use the manual	1-1
Safety Messages (review carefully)	1-2
DTC400e/C30e/M30e Card Printer Overview	1-3
Reviewing the DTC400e/C30e/M30e Block Diagram	1-3
Reviewing the DTC400e/C30e/M30e Card Printer Sequence of Operations	1-4
Reviewing the DTC400e/C30e/M30e Boot up Sequence	1-7
<b>Section 2: Specifications</b>	<b>2-1</b>
Regulatory Compliances	2-1
Agency Listings	2-2
Technical Specifications	2-2
Functional Specifications	2-5
Printer Components: Front Cover to USB Port	2-6
Printer Components: Print Ribbons	2-7
Printer Components: Resin-Only Print Ribbons	2-8
Printer Components: Dye-Sublimation Print Ribbons	2-9
Printer Components: Dye-Sublimation/Resin Print Ribbons	2-10
Dye-Sublimation Ribbons for M30e	2-10
Printer Components: Blank Cards	2-11
<b>Section 3: Printer Setup &amp; Installation</b>	<b>3-1</b>
Choosing A Good Location	3-1
About Moisture Condensation	3-1
Unpacking and Inspection	3-2
Reviewing the Printer (front view)	3-2
Connecting the Printer power	3-3
Flipper Table Module Assembly	3-4
Installing the Print Ribbon Cartridge	3-5
Installing Blank Cards into the Card Hopper	3-7
Lowering the Card Output Hopper	3-10
Printer Driver Installation	3-11
Printing a Test Print Image	3-20
Printer Transport	3-21
<b>Section 4: General Troubleshooting</b>	<b>4-1</b>
Safety Messages (review carefully)	4-1
Communications Errors	4-2
Print Process Errors	4-4
Resolving a Card Not Fed Error (Cards will not feed off the Hopper)	4-4
Resolving a Card Not Fed Error (Two (2) or more cards feed at the same time)	4-7
Resolving a Ribbon RFID Error (Ribbon RFID Antenna is Corrupted)	4-9
Resolving the Mag Verify Error	4-10
Resolving the No Magnetic Encoder Installed Error	4-13
Resolving the No Mag Stripe Present Error	4-15
Resolving the No Smart Card Encoder Error	4-16
Resolving the No Prox Card Encoder Error	4-18
Resolving a Ribbon Sensor Error (Ribbon Miscue) DTC400e & C30e	4-20
Resolving a Ribbon Break Jam Error	4-21
Resolving a Ribbon Out Error	4-24
Resolving a No Ribbon Installed Error	4-25
Resolving a Invalid Ribbon Error	4-26
Resolving a Wrong Ribbon Error	4-28
Resolving a Card Jam Error	4-30

Resolving a Card Jam (Encoder) Error	4-32
Resolving a Headlift Motor or Sensor Error	4-34
Resolving the Cover Open issue	4-36
Resolving the Blank Output issues	4-37
Resolving the Remove Ribbon Message (Rewriteable Job)	4-39
Flipper Table Module Assembly Problems	4-40
Resolving the No Flipper Table Module problem	4-40
Resolving the Flipper Jam Error	4-41
Diagnosing Image Problems	4-43
Resolving the Pixel Failure problems	4-43
Resolving the Card Surface Debris problems	4-44
Resolving the Incorrect Image Darkness problems	4-45
Resolving Ribbon Wrinkle problems	4-47
Resolving the Excessive Resin printing problems	4-49
Resolving the Incomplete Resin printing problems	4-51
Resolving the Image Placement problems	4-52
Resolving the Poor Image Quality problems	4-56
Running the Self Test	4-57
Running the Standard Self Test Print	4-58
<b>Section 5: Ethernet Option Introduction</b>	<b>5-1</b>
Technical Specification - Ethernet Option	5-1
Functional Specification - Ethernet Option	5-2
Network Services - Overview	5-3
Reviewing the Print Server	5-3
Reviewing the Web Page Server	5-3
Reviewing the Network Management Interface	5-3
Reviewing the Telnet Server	5-3
Network Management Interface	5-4
Telnet Command Line Interface	5-4
Initiating a Telnet Session	5-4
Reviewing the Telnet Command Table	5-5
<b>Ethernet Printer Troubleshooting Procedures</b>	<b>5-9</b>
Verifying the Printer Connection	5-10
Verifying the Printer IP address	5-10
Verify that the PC can access the Printer using the ping command	5-11
Printing a test page	5-12
<b>Reviewing Frequently-asked Questions</b>	<b>5-13</b>
<b>Glossary of Terms</b>	<b>5-17</b>
<b>Section 6: Printer Adjustments</b>	<b>6-1</b>
Safety Messages (review carefully)	6-1
DTC400e/C30e/M30e Print Driver Options	6-2
<b>Using the Card tab (DTC400e/C30e/M30e)</b>	<b>6-3</b>
Adjusting the Card Size Option	6-3
Adjusting the Orientation Option	6-4
Selecting the number of copies	6-5
Using the Diagnostics button under the Card tab	6-6
Using the Clean Printer Option	6-7
Using the Test Print button	6-9
Using the About button	6-10
Using the Device Options tab (DTC400e/C30e or M30e)	6-11
Adjusting the Ribbon Type option	6-13
Selecting the Auto Ribbon Select option	6-16

Adjusting the Color Matching option _____	6-20
Adjusting for the Resin Dither _____	6-21
Using the Print Both Sides option _____	6-22
Using the Split 1 Set of Ribbon Panels option _____	6-23
Using the Print Back Side First option _____	6-24
Using the Print Back Side Only option _____	6-25
Using the Rotate Front 180 Degrees or Rotate Back 180 Degrees options _____	6-26
Using the Disable Printing option _____	6-27
Using the Image Color tab (DTC400e/C30e/M30e) _____	6-28
Using the Resin Heat (K) option (Front and Back) _____	6-29
Using the Overlay Heat (O) option _____	6-30
Using the Color Matching option and Default button _____	6-31
<b>Using the Calibrate tab (DTC400e/C30e/M30e) _____</b>	<b>6-32</b>
Using the Image Position Controls _____	6-33
Using the Sensors button _____	6-35
Using the Settings button _____	6-37
<b>Using the Magnetic Encoding tab _____</b>	<b>6-38</b>
Using the Encoding Mode dropdown list _____	6-39
Selecting the Coercivity/Magnetic Track _____	6-45
Reviewing the Shift Data Left Function _____	6-46
Reviewing the Magnetic Track Options _____	6-47
Using the Character Size buttons _____	6-49
Using the ASCII Offset dropdown list _____	6-50
Using the Bit Density dropdown list _____	6-51
Using the LRC Generation dropdown list _____	6-52
Using the Character Parity dropdown list _____	6-53
Reviewing the ISO Track Locations _____	6-54
Sending the Track Information _____	6-55
Reviewing the Sample String _____	6-56
Reviewing the ASCII Code and Character Table _____	6-57
<b>Using the Overlay / Print Area tab (DTC400e/C30e/M30e) _____</b>	<b>6-58</b>
Enabling the Back options _____	6-59
Using the Front option (Overlay / Print Area) _____	6-60
Using the Back option (Overlay / Print Area) _____	6-61
Using the Overlay / Print Area dropdown menu _____	6-62
Using the Overlay / Print Area _____	6-64
Using the Defined Area Option _____	6-66
Using Security Options (Visual Security Solutions) (Front option only) _____	6-70
Selecting Orientation - Landscape under Card tab _____	6-71
Selecting the Visual Security Solutions dropdown menu (A to D) _____	6-72
Selecting Orientation - Portrait under Card tab _____	6-73
Selecting the Visual Security Solutions dropdown menu (E to H) _____	6-74
Selecting the VeriMark radio button (Frontside option only) _____	6-75
Selecting HoloMark (Front option only) _____	6-76
Reviewing the Custom VeriMark Card (Custom Graphic in a 2D foil) _____	6-77
Reviewing the Custom HoloMark Card (Custom Graphic in a 2D foil) _____	6-78
<b>Using the K Panel Resin tab (DTC400e/C30e/M30e) _____</b>	<b>6-79</b>
Enabling the Frontside and Backside options _____	6-80
Enabling the Frontside option (K Panel Resin) _____	6-81
Enabling the Backside option (K Panel Resin) _____	6-82
Selecting from the Print All Black with K Panel options (Front and Back options) _____	6-83
Selecting the Full Card option (Front and Back options) _____	6-84
Selecting the Defined Area(s) option (Front and Back options) _____	6-85

Selecting the Undefined Area(s) option (Front and Back options)	6-86
Selecting the Defined Area(s) function (Front and Back options)	6-87
Selecting the Print YMC under K and Print K Only options	6-94
<b>Using the Printer Info tab (DTC400e/C30e/M30e)</b>	<b>6-95</b>
Reviewing the Ribbon Information	6-96
Reviewing the Ribbon Level Indicator	6-96
<b>Using the Printer Calibration Utility (DTC400e/C30e/M30e)</b>	<b>6-97</b>
Using the Image Darkness Option	6-98
Using the Print Top of Form Option	6-99
Using the Print End of Form Option	6-100
Using the Print Left of Form Option	6-101
Using the Magnetic Encoder Voltage Offset Option	6-102
Adjusting the Hi-Co Voltage Offset	6-103
Adjusting the Lo-Co Voltage Offset	6-104
Using the Mag Top of Form Option	6-105
Using the Ribbon Tension Option	6-107
Using the Flipper Home Offset Option	6-108
Using the Flipper Center Offset Option	6-108
Using the Flipper Smart Angle Offset Option	6-109
Using the Resin Heat (K) Adjustment (Settings)	6-110
Using the Print Temperature Offset	6-111
Using the Erase Temperature Offset	6-112
Using the Flipper Prox Offset Option	6-113
Using the Flipper Prox Angle Offset Option	6-114
<b>Section 7: Using the YMCFKO Ribbon in the Workbench</b>	<b>7-1</b>
Adding a Secure ID to the Card	7-4
Changing the Secure ID Properties	7-5
Adding a Logo to the Card	7-6
Changing the Logo Properties	7-7
Adding a Text on the Card	7-8
Changing the Text Properties	7-9
Fluorescing Panel – Application Specifications	7-10
Inserting Fluorescent Text	7-10
Insert Fluorescent Image	7-11
Printing Dynamic Text	7-11
<b>Selecting the NONE- Re-Writable Ribbon Type DTC400e/C30e</b>	<b>7-12</b>
Using the Workbench (to erase the card)	7-13
Using the Erase Intensity Option (DTC400e/C30e)	7-15
Using the Erase Temperature Offset	7-16
<b>Section 8: Cleaning</b>	<b>8-1</b>
Safety Messages (review carefully)	8-1
Supplies (included with the Cleaning Kit)	8-2
Cleaning the Printhead	8-3
Cleaning the Platen and the Card Feed Rollers	8-4
Cleaning the Printer's Interior	8-6
Cleaning the Printer's Exterior	8-6
Packing the Card Printer	8-1
<b>Section 9: Firmware Upgrades</b>	<b>9-1</b>
Requirements	9-1
Safety Messages (review carefully)	9-1
Upgrade the Printer Firmware	9-2

<b>Section 10: Fargo Technical Support</b>	<b>10-1</b>
Contacting Fargo Technical Support	10-1
Reading the Serial Numbers on a Fargo Printer	10-2
Finding out when a Fargo Card Printer was manufactured	10-2
Reviewing Example No. 1: Serial Number A9020001	10-2
<b>Section 11: Glossary of Terms</b>	<b>11-1</b>

# Section 1: Introduction



## How to use the manual

The DTC400e/Persona C30e/M30e Card Printer User Guide is designed to provide Installers and Technicians with quick, efficient lookup of related procedures, components and terms. The manual can be used effectively either in soft or hard copy, depending on the preference of the Installer or Technician.

<b>Manual</b>	<b>Description</b>
Sequence of Operations, Glossary of Terms and Technical/Functional Specifications (hyper-linked)	You can go directly to the Sequence of Operations, Glossary of Terms, Technical Specifications and Functional Specifications to learn how to use the processes, procedures, functions and windows for the card Printer within concise, correlative tables.
Table of Contents (hyper-linked)	You can use the automated Table of Contents to quickly locate, for example, an error message, a procedure, the index or an appendix.
Troubleshooting, Replacement, Removal, Diagnostic and Navigation Procedures (in hyper-linked Sections)	You can go directly to Specifications, General Troubleshooting, Printer Adjustments, Parts Replacement, Printer Packing, Board Level Diagnostics and Firmware Updates to find troubleshooting, removal and replacement procedures. The section titles are always labeled according to their function for consistent usage.
Cross-Referencing (hyper-linked)	You can use the cross-referencing links to quickly locate, for example, an error message or a procedure.
Comprehensive Index (hyper-linked)	You can use the COMPREHENSIVE INDEX to quickly locate information on the card Printer, relating to a specification, a procedural step, a window or screen, a component, a term, a qualifier or a related feature to this Printer.



## Safety Messages (review carefully)

Symbol	Critical Instructions for Safety purposes
<p><b>Danger:</b></p> 	<p><b>Failure to follow these installation guidelines can result in death or serious injury.</b></p> <p>Information that raises potential safety issues is indicated by a warning symbol (as shown to the left).</p> <ul style="list-style-type: none"> <li>• <b>To prevent personal injury</b>, refer to the following safety messages before performing an operation preceded by this symbol.</li> <li>• <b>To prevent personal injury</b>, always remove the power cord prior to performing repair procedures, unless otherwise specified.</li> <li>• <b>To prevent personal injury</b>, make sure only qualified personnel perform these procedures.</li> </ul>
<p><b>Caution:</b></p> 	<p><b>This device is electrostatically sensitive. It may be damaged if exposed to static electricity discharges.</b></p> <p>Information that raises potential electrostatic safety issues is indicated by a warning symbol (as shown to the left).</p> <ul style="list-style-type: none"> <li>• <b>To prevent equipment or media damage</b>, refer to the following safety messages before performing an operation preceded by this symbol.</li> <li>• <b>To prevent equipment or media damage</b>, observe all established Electrostatic Discharge (ESD) procedures while handling cables in or near the Circuit Board and Printhead Assemblies.</li> <li>• <b>To prevent equipment or media damage</b>, always wear an appropriate personal grounding device (e.g., a high quality wrist strap grounded to avoid potential damage).</li> <li>• <b>To prevent equipment or media damage</b>, always remove the Ribbon and Cards from the Printer before making any repairs, unless otherwise specified.</li> <li>• <b>To prevent equipment or media damage</b>, take jewelry off of fingers and hands, as well as thoroughly clean hands to remove oil and debris before working on the Printer.</li> </ul>

# DTC400e/C30e/M30e Card Printer Overview

## Reviewing the DTC400e/C30e/M30e Block Diagram

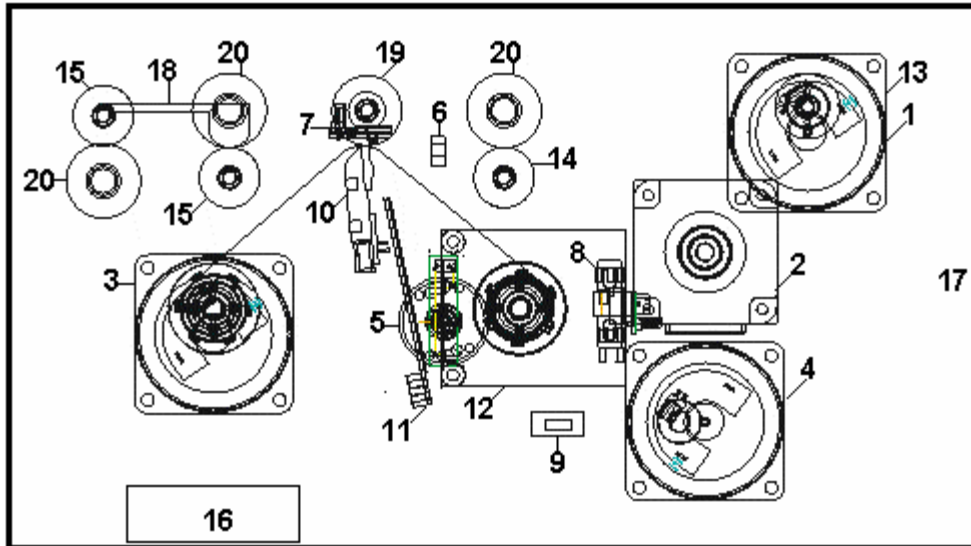

Motors	
1	Card Feed
2	Print Stepper
3	Ribbon Drive
4	Print Headlift
5	Ribbon Rewind Motor

Sensors	
6	Card Feed
7	Ribbon Sensor
8	Ribbon Encoder
9	Headlift Sensor
10	Printhead Thermistor
11	Ribbon LED SNR
12	RFID Antenna

Parts	
13	Card Input Roller
14	Cleaning Roller
15	Card Feed Roller
16	Printhead Cooling Fan
17	Card Input Hopper
18	Magnetic Encoding Head Module
19	Platen Roller
20	Pinch Roller

## Reviewing the DTC400e/C30e/M30e Card Printer Sequence of Operations

The following sequence describes a full color print job with magnetic encoding.

Step	Process
1	The File information is received from the PC.
2	Printer checks the installed Ribbon type (stored in memory) against the Ribbon type command that was sent from the Printer. <ul style="list-style-type: none"> <li>• If Ribbon type does not match, the <b>Pause</b> button on the right will begin flashing.</li> </ul>
3	The Card Input Motor and Print Stepper Motor engage.
4	The Card Feed Sensor detects leading edge of card and disengages the card input Motor.

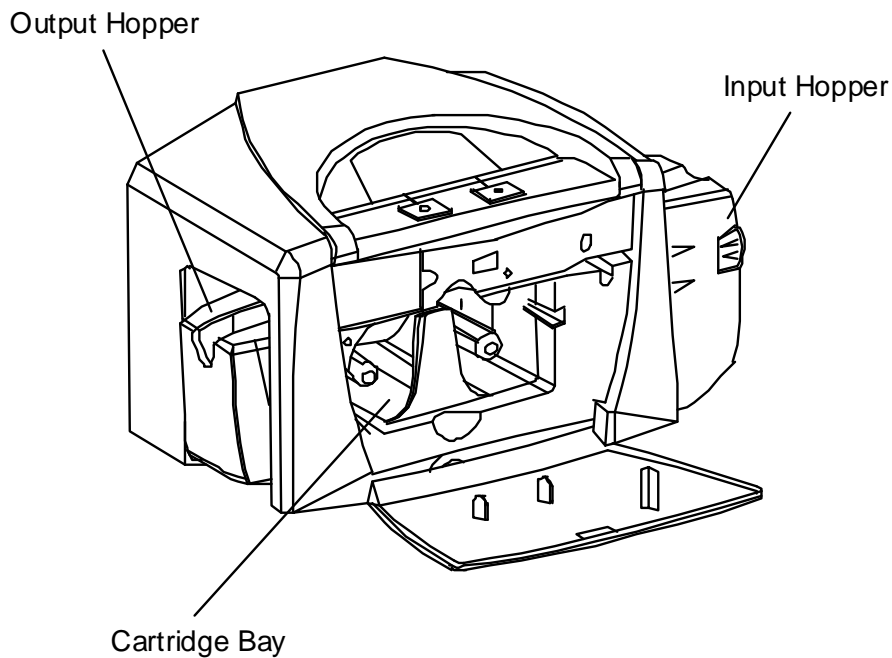

5	The Card Feed Stepper Motor engages to queue card for magnetic encoding.
6	The Encoding data is written to the card.
7	The Magnetic Encoder verifies while the Stepper reverses the card.
8	The Print Ribbon Drive engages.

9	The Print Ribbon Sensor looks for the Yellow panel. ( <b>Note:</b> The Print Ribbon Encoder detects number of revolutions, required to use an entire color panel.) (C30e & DTC 400e only)
10	The Print Stepper Motor engages.
11	The Card Feed Sensor detects trailing edge of card.
12	The Print Stepper Motor queues card to the middle of the platen Roller. All Stop.
13	The Print Headlift Motor engages.
14	The Print Headlift Sensor detects the closed state.
15	The Print Headlift Motor disengages.
16	The Print Stepper Motor engages.
17	The Print Cover Sensor checks for a closed state.
18	The Ribbon Drive Motor engages.
19	The Image data is burned by the Printhead until the image data is depleted. All Stop.
20	The Thermistor engages the Printhead Cooling Fan to maintain proper operating temperature.
21	The Headlift Motor engages.
22	The Print Headlift Sensor detects an open state.
23	The Print Headlift Motor disengages.
24	The Print Stepper Motor engages.
25	The Print Ribbon Drive engages.
26	After Ribbon advances a few encoder clicks, assume Ribbon free of card. All Stop.
27	Repeat steps 9 through 22 for the appropriate number of color/overlay panels.
28	The Card is ejected from the singled-sided Printer. <b>OR</b> The Card Feed Stepper engages to queue the card for the Flipper Table for the dual-sided Printer.
29	All Stop.



## Reviewing the DTC400e/C30e/M30e Boot up Sequence

Step	Process
1	On Power up, the Printer checks the current state of the Card Feed Sensor and the Headlift Sensor.
2	If the Headlift Sensor is found to be open, the Headlift Motor will turn until a closed state is seen.
3	If the Card Feed Sensor is found to be blocked, the Card Feed Stepper will engage to eject the card.

## Section 2: Specifications

The purpose of this section is to provide the User with specific information on the Regulatory Compliances, Agency Listings, Technical Specifications and Functional Specifications for the DTC400e/Persona C30e/M30e Card Printer User Guide.

### Regulatory Compliances

Term	Description
CSA (cUL)	<p>The Printer manufacturer has been authorized by UL to represent the Card Printer as CSA Certified under CSA Standard C22.2 No. 60950-1-03.</p> <p><b>File Number:</b> E145118</p>
FCC	<p>The Card Printer complies with the requirements in Part 15 of the FCC rules for a Class B digital device. (<b>Note:</b> These requirements are designed to provide reasonable protection against harmful interference in a residential installation.)</p> <p>If equipment operation in a residential area causes unacceptable interference to radio and TV reception, the operator is required to take whatever steps are necessary to correct the interference.</p>
ITS-EMC	<p>The Card Printer has been tested and complies with EN55022 Class B: 1995 and EN82082-1: 1997 standards for EMI emissions.</p> <p>(<b>Note:</b> Based on the above testing, the Printer manufacturer certifies that the Card Printer complies with all current EMC directives of the European Community and has placed the CE mark on the Card Printer.)</p> <p><b>License Number:</b> J99032510</p>
UL	<p>The Card Printer is listed under UL IEC 60950-1 (2001) INFORMATION TECHNOLOGY EQUIPMENT.</p> <p><b>File Number:</b> E145118</p>

## Agency Listings

Term	Description
Emissions Standards	CE, FCC, CRC c1374, EN 55022 Class B, FCC Class B, EN 55024: 1998, EN 61000-3-2 and EN 61000-3-3.
Safety Standards	UL IEC 60950-1 (2001), CSA C22.2 No. 60950-1-03.

## Technical Specifications

Type	Description
Accepted Standard Card Sizes	<ul style="list-style-type: none"> <li>CR-80 (3.375"L x 2.125"W / 85.6mmL x 54mmW)</li> <li>CR-79 (3.295"L x 2.043"W / 83.7mmL x 51.9mmW)</li> </ul>
Accepted Card Thickness	9 mil to 40 mil (.009"/.23mm to .040" /1.02mm)
Accepted Card Types	PVC, polyester cards with polished PVC finish. Re-Writable cards (C30e & DTC 400e only).
Agency Listings	<p><b>Safety:</b> UL IEC 60950-1 (2001), CSA C22.2 No. 60950-1-03.</p> <p><b>Emissions:</b> CE, FCC, CRC c1374, EN 55022 Class B, FCC Class B, EN 55024: 1998, EN 61000-3-2 and EN 61000-3-3.</p>
Card Input Hopper Capacity	100 cards (30 mil)
Colors	Up to 16.7 million: Monochrome (M30e monochrome only)
Dimensions	See the Size and Weight information in this same table.
Humidity	20-80% non-condensing
Interface	USB 20.



Type	Description
ISO Magnetic Encoding	<ul style="list-style-type: none"> <li>• <b>ISO:</b> This option allows the user to select magnetic encoding that conforms to ISO standard 7811, Parts 1-7.</li> <li>• <b>ISO Coercivity:</b> ISO magnetic encoding option provides selectable options for either High or Low Coercivity.</li> </ul> <p>See the <a href="#">Using the Magnetic Encoding tab</a> section.</p>
Memory	2MB RAM
Monochrome Printing	<p>The C30e shall render rewriteable card images using a monochrome color pallet.</p> <p>The M30e shall render card images using a monochrome pallet.</p>
Operating Temperature	65° to 80° F / 18° to 27° C
Print Area	CR-80 edge-to-edge
Printer Drivers	32-bit Windows 2000/XP/2003/VISTA ( 32 bit & 64 bit)
Print Method	<ul style="list-style-type: none"> <li>• Dye-Sublimation/Resin Thermal Transfer</li> <li>• Resin Thermal Transfer</li> </ul>
Print Speed	<p>Print Speeds**</p> <ul style="list-style-type: none"> <li>• 7 seconds per card / 514 cards per hour (K, Color Resin)*</li> <li>• 12 seconds per card / 300 cards per hour (KO, BO)</li> <li>• 27 seconds per card / 133 cards per hour (YMCKO)*</li> <li>• 35 seconds per card / 102 cards per hour (YMCKOK)*</li> </ul> <p>*Indicates the Ribbon type and the number of Ribbon panels printed where Y=Yellow, M=Magenta, C=Cyan, K=Resin Black, O=Overlay,</p> <p>**Print speed indicates an approximate batch print speed and is measured from the time a card feeds into the printer to the time it ejects from the printer.</p> <p>Print speeds do not include encoding time or the time needed for the PC to process the image. Process time is dependent on the size of the file, the CPU, amount of RAM and the amount of available resources at the time of the print.</p>

Type	Description
Resolution	300 dpi (11.8 dots/mm)
Supply Voltage	100-240 VAC, .6-1.0 A
Supply Frequency	50 Hz/60 Hz
System Requirements	<ul style="list-style-type: none"> <li>• x86 based PC or compatible</li> <li>• Windows 2000, Windows XP, Windows 2003, Windows Vista (32 bit &amp; 64 Bit)</li> <li>• 500MHz computer with 256MB of RAM or higher</li> <li>• 500MB free hard disk space or higher</li> </ul>
Weight and Size	<ul style="list-style-type: none"> <li>• <b>Single-sided (weight):</b> 8 lbs. / 3.65 kg</li> <li>• <b>Single-sided (size):</b> 7.90"H x 13.62"W x 8.14"D / 200mmH x 346mmW x 207mmD</li> <li>• <b>Dual-sided (weight):</b> 12 lbs. / 5.45 kg</li> <li>• <b>Dual-sided (size):</b> 7.9"H x 18.28"W x 8.14"D / 200mmH x 465mmW x 207mmD</li> </ul>

## Functional Specifications

This Card Printer utilizes two different, yet closely related printing technologies to achieve its remarkable direct-to-card print quality for dye-sublimation and resin thermal transfer.

The following describes how each of these technologies works:

Function	Description
Dye-Sublimation	<p>Dye-Sublimation is the print method the Persona C30e/M30e uses to produce smooth, continuous-tone images that look truly photographic. (<b>Note:</b> This process uses a dye-based Ribbon roll that is partitioned by a number of consecutive color panels.)</p> <p>The panels are grouped in a repeating series of these three process colors along the entire length of the print Ribbon: yellow, magenta and cyan or YMC.</p> <p>The Printer always prints the yellow panel first, followed by the magenta panel and the cyan panel. (<b>Note:</b> As the print Ribbon passes beneath the Printhead, hundreds of thermal elements within the Printhead heat the dyes on the Ribbon. When these dyes are heated, they diffuse into the surface of the card. A separate pass is made for each of the three color panels on the Ribbon.)</p> <p>By combining the colors of each panel and by varying the heat used to transfer these colors, it is possible to print up to 16.7 million different shades of color. (<b>Note:</b> This blends one color smoothly into the next, producing photo-quality images with absolutely no dot pattern.)</p>
Resin Thermal Transfer	<p>Resin Thermal Transfer is the print method the Printer uses to print sharp black text and crisp bar codes, which can be read by both infrared and visible-light bar code scanners.</p> <ul style="list-style-type: none"> <li>• Used to print ultra-fast, one-color ID cards on the Persona C30e/M30e. (<b>Note:</b> Like dye-sublimation, this process uses the same thermal Printhead to transfer color to a card from a resin-only print Ribbon or the resin black (K) panel of a full color print Ribbon.)</li> <li>• Solid dots of resin-based ink are transferred and fused to the surface of the card. (<b>Note:</b> This produces durable, saturated printing.)</li> </ul>

## Printer Components: Front Cover to USB Port

Components	Description
Front Cover	Opens to allow access to the Ribbon Cartridge. <b>(Note:</b> This cover must be closed in order for the Printer to begin printing.)
Printhead	The component of the Printer that actually does the printing. <b>(Note:</b> This component is fragile and must not be bumped or touched with anything other than a cleaning swab.)
<b>Cancel</b> button	The <b>Cancel</b> button  turns the Printer ON and OFF. <b>(Note:</b> It also serves to cancel the current print job and reset the Printer for the next print job.)  If a card is left within the Printer after a print job is canceled, it will automatically be ejected when the Printer is turned back ON.
<b>Pause</b> button	The <b>Pause</b> button is used to pause the Printer during normal operation and also to resume operation after an error condition is cleared. <b>(Note:</b> In general, as the icon above this button indicates, errors are related to either the Ribbon or the cards. If an error occurs, the Pause LED will flash.)
Card Cleaning Roller	Automatically cleans cards for higher print quality.
Card Input Hopper	Load blank cards into this Hopper.
Power Port	Connect to the included power cord.
USB Port	Connect to a Windows PC with a USB cable.

## Printer Components: Print Ribbons

The Card Printer utilizes both dye-sublimation and/or resin thermal transfer methods to print images directly onto blank cards. Since the dye-sublimation and the resin thermal transfer print methods each provide their own unique benefits, print Ribbons are available in resin-only, dye-sublimation-only and combination dye-sublimation/resin versions.

To make it easier to remember which print Ribbons are which, a letter code has been developed to indicate the type of Ribbon panels found on each Ribbon. This letter code is as follows:

C30e & DTC400e



= Dye-Sublimation Yellow Panel



= Dye-Sublimation Magenta Panel

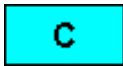

= Dye-Sublimation Cyan Panel



= Resin Black Panel

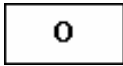

= Clear Protective Overlay Panel



= Ultra Violet Fluorescing Panel DTC 400e

M30e

**B** = Dye-Sub Black Panel



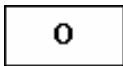

= Resin Black Panel



= Clear Protective Overlay Panel

## Printer Components: Resin-Only Print Ribbons

Resin-only print Ribbons consist of a continuous roll of a single resin color. No protective overlay panel (O) is provided since resin images do not require the protection of such an overlay. The following resin-only Ribbon types are available for use with the DTDC400e/Persona C30e/M30e.





Type	Description
Standard Resin Black (K) (provides 1,000 prints)	<p>This Ribbon provides high resin durability ideal for most general-purpose monochrome ID card applications. Resin black bar codes are readable by both infrared and visible-light bar codes scanners.</p> 
Premium Resin Black (K) (provides 1,000 prints)	<p>This Ribbon provides maximum resin durability ideal for applications such as access control where cards are repeatedly swiped through a Magnetic Stripe reader. Resin black bar codes are readable by both infrared and visible-light bar codes scanners.</p> <p><b>(Note:</b> Using a Premium Resin Black Ribbon will provide better photo realistic output.)</p> 
Colored Resin (provides 1,000 prints)	Several colored resin Ribbons are available in a variety of colors for customizing or color-coding resin-only ID cards.
Metallic Resin (provides 500 prints)	Metallic resin Ribbons are available for printing resin images with a unique metallic sheen.

## Printer Components: Dye-Sublimation Print Ribbons

Note that the Printer requires both specialized and authorized print Ribbons in order to print and function properly.

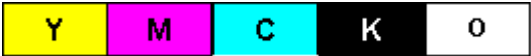
Step	Procedure
1	<p>Do not run the cards with a contaminated, dull or uneven surface through the Printer.</p>  <p><b>Caution:</b> Printing onto such cards will ultimately lead to poor print quality and will greatly reduce the life of the Printhead.</p>
2	<p>Always store the card stock in its original packaging or in a clean, dust-free container.</p>
3	<p>Do not print onto cards that have been dropped or soiled. (<b>Note:</b> Printhead damage caused by contaminated or poor quality cards will automatically void the Printhead's factory warranty.)</p>
4	<p>If printing onto cards with a pre-punched slot, do not print over the area of the card with the punched slot. (<b>Note:</b> To avoid this area when printing, use the options in the Overlay / Print Area tab to omit printing in this area or punch the slot after the card has printed.)</p>

## Printer Components: Dye-Sublimation/Resin Print Ribbons

Type	Description
Dye-Sublimation/resin print Ribbon	<p>The Dye-Sublimation/resin print Ribbon combines the yellow (Y), magenta (M) and cyan (C) dye-sublimation panels with a resin black (K) panel.</p> <p>By combining both types of Ribbon panels, this Ribbon can be used to print full-color, photo-quality images with the dye-sublimation panels along with sharp, black text and bar codes with the resin black panel.</p> <p>A clear overlay panel (O) is also included on most Ribbons to protect the dye-sublimation images. Dye-Sublimation images must have an overlay panel applied to them or they will quickly begin to wear or fade.</p>
Full-Color (YMCKO) (provides 250 prints)	<p>This Ribbon is used to print full-color photo ID cards along with resin black text and bar codes. Both infrared and visible-light bar code scanners can read bar codes printed with resin black.</p> <ul style="list-style-type: none"> <li>An overlay panel (O) is included to protect the full-color dye-sublimation printing.</li> </ul> 
YMCKOK	<p>The designation of colored Ribbon by the Panels of color in the order in which they are printed: Yellow (Y), Magenta (M), Cyan (C), Black (K), Overlay (O), Black (K) (used for backside, black only printing).</p> 
YMCFKO	<p>Here are the colored Ribbon designations. The Panels of color are displayed in the order in which they are printed: Yellow (Y), Magenta (M), Cyan (C), Fluorescent (F), Black (K), Overlay (O).</p> 
YMCFKOK	<p>Here are the colored Ribbon designations. The Panels of color are displayed in the order in which they are printed: Yellow (Y), Magenta (M), Cyan (C), Fluorescent (F), Black (K), Overlay (O) and Black (K) (used for backside, black only printing.)</p> 

### Dye-Sublimation Ribbons for M30e

Type	Description
BO	The BO print Ribbon uses the Black (B) dye-sublimation panel



	A clear overlay panel (O) is also included Ribbons to protect the dye-sublimation images. Dye-Sublimation images must have an overlay panel applied to them or they will quickly begin to wear or fade.
--	---

## Printer Components: Blank Cards

Type	Description
Card Size	The Card Printer accepts standard CR-80 and CR-79 sized cards.
Card Design	The Printer will print onto any card with a clean, level and polished PVC surface.  Although the Printer is equipped with card cleaning Rollers, it is very important to always print onto cards specifically designed for direct-to-card dye-sublimation printing.
Card Surface	Suitable cards must have a polished PVC surface free of fingerprints, dust or any other types of embedded contaminants. In addition, cards must have a completely smooth, level surface in order for the Printer to achieve consistent color coverage.  Certain types of Proximity cards have an uneven surface that will inhibit consistent color transfer. <ul style="list-style-type: none"> <li>• Certain types of smart card chips are raised slightly above the cards surface which also results in poor color transfer.</li> </ul>
UltraCard Stock	Due to the importance of using high-quality blank cards, a factory-approved card stock called UltraCard™ is available and recommended for best results. <ul style="list-style-type: none"> <li>• UltraCard stock has a glossy PVC laminate on top and bottom and is optically inspected to provide the cleanest, most scratch and debris-reduced cards possible.</li> <li>• Two types of these cards are available: UltraCard and UltraCard III. UltraCard stock has a PVC core and offers medium card durability. UltraCard III stock has a 40% polyester core and offers high durability.</li> <li>• Both types of UltraCards produce printed images with a glossy, photo-quality finish.</li> </ul>

The following guide will walk you through the installation of the Persona C30e/M30e Card Printer Driver.

- **Time Requirement (software):** This software installation process will require approximately 2 to 5 minutes (depending on the speed of your PC).
- **Time Requirement (Printer):** The time required to set up a standard Persona C30e/M30e Printer would be approximately 5 to 10 minutes.

The System Requirements are as follows:

- x86 PC or compatible, Windows 2000, Windows XP, Windows 2003, 500MHz computer with 256MB of RAM or higher, 500MB free hard disk space or higher
- Printer Setup and Installation

# Section 3: Printer Setup & Installation

## Choosing A Good Location

Follow these guidelines:

- Place the unit in a location with adequate air circulation to prevent internal heat build up.
- Use the Printer's dimensions as a guideline for the minimum clearances to the unit.  
(**Note:** Allow for adequate clearance in front of the unit to accommodate the unit with its Covers open.)
- Do not install unit near heat sources such as radiators or air ducts or in a place **subject to direct sunlight**, excessive dust, mechanical vibration or shock.

## About Moisture Condensation

If the unit is brought directly from a cold to a warm location or is placed in a very damp room, moisture may condense inside the unit. Should this occur, print quality may not be optimum.

Leave the unit turned OFF in a warm, dry room for several hours before using. This will allow the moisture to evaporate.

## Unpacking and Inspection

While unpacking your Printer, inspect the carton to ensure that no damage has occurred during shipping. Make sure that all supplied accessories are included with your unit.

Check that the following items are included:

- Power Supply
- US / EU Power Cable
- Software Installation CD/User Guide
- User Guide
- Warranty Statement, Registration Card and Compliancy Document

## Reviewing the Printer (front view)

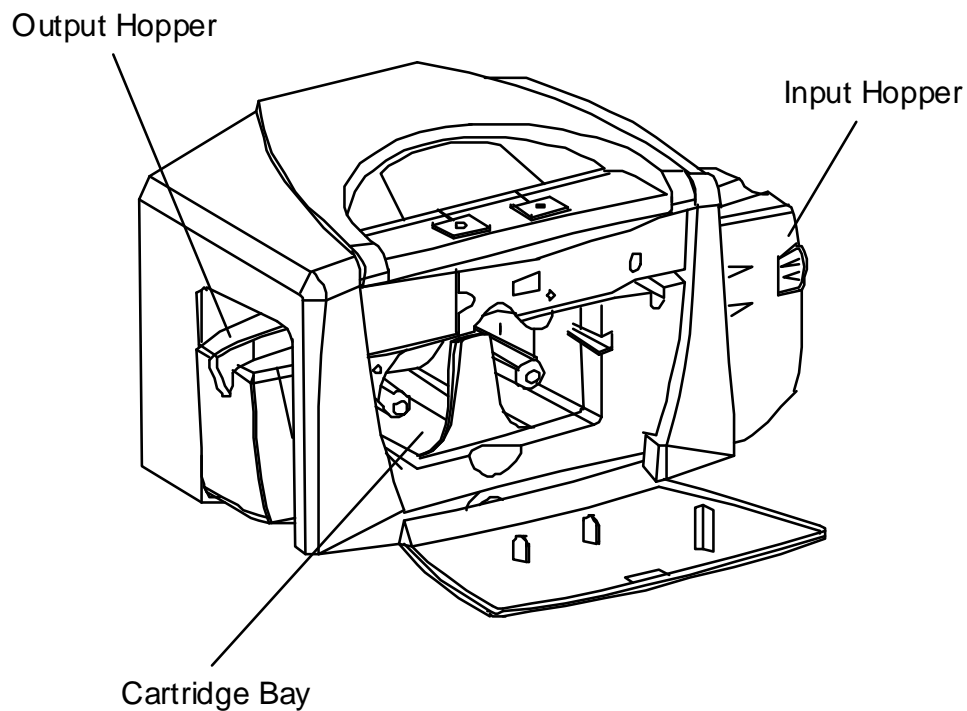

**Reviewing the Printer (front view; Cartridge being installed)**

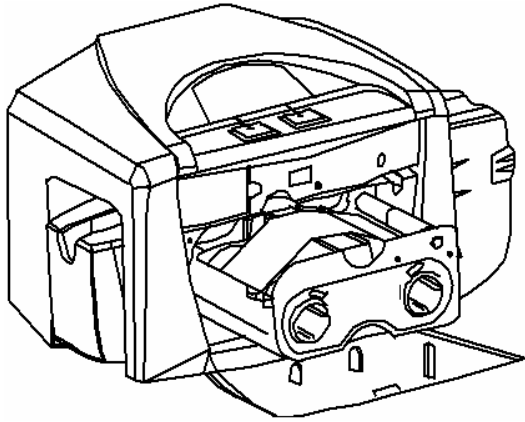

**Connecting the Printer power**

Follow this procedure. (**Note:** Do not connect the Printer’s USB cable until prompted during the Printer Driver installation.)

Step	Procedure
1	Plug the AC adapter power cable into the back of the Printer. See Display A.
2	Plug the wall power cable into the AC power adapter.
3	Plug the wall power cable into a standard 110VAC power outlet.

Display A – Shows back of Printer with AC power cable (below).

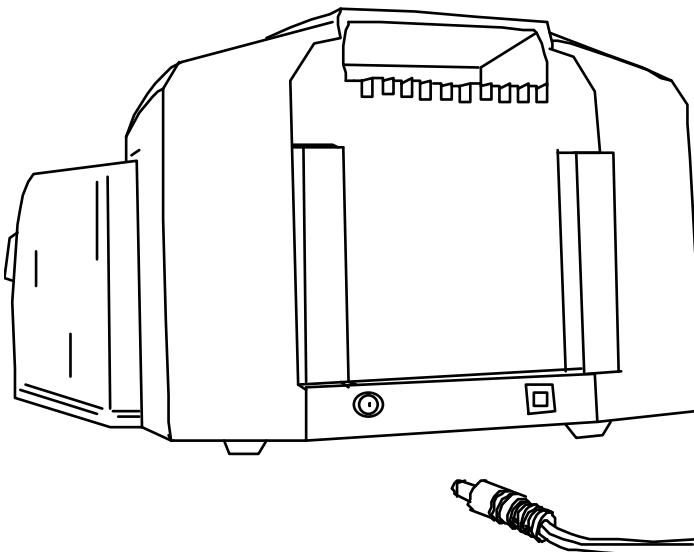

## Flipper Table Module Assembly

The Flipper Table Module Assembly (D900200) is an automated Flipping Module that allows the Printer to print on the frontside and backside of each card.

**Display:** Flipper Table Module Assembly

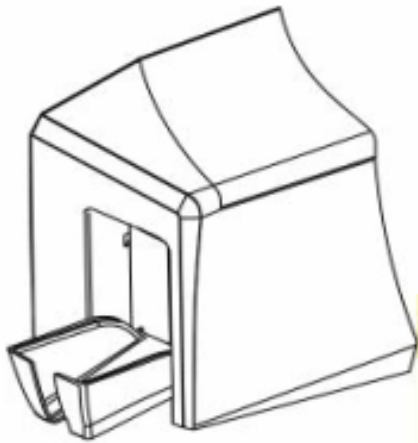

## Installing the Print Ribbon Cartridge

The DTC400e/C30e/M30e Card Printer uses a one-piece, disposable Ribbon Cartridge load system.

Step	Procedure
1	To install the Ribbon Cartridge, simply open the front Cover by pressing the black rubber pad or touch pad and lowering the Cover down, as shown below.

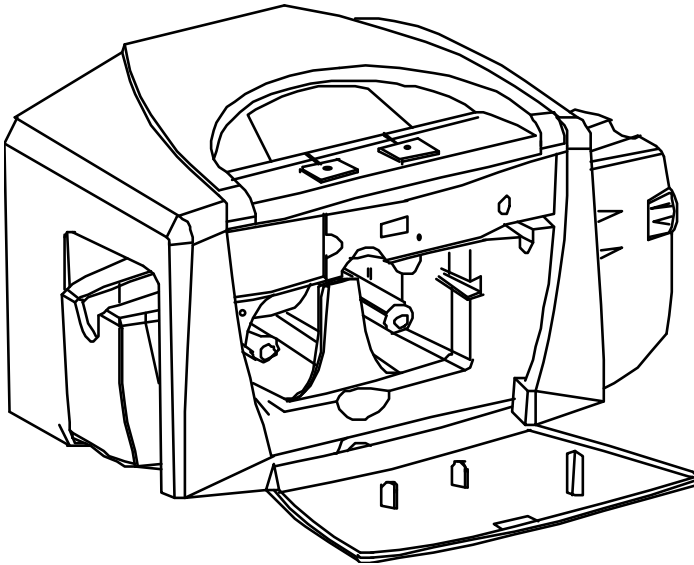

2	<ol style="list-style-type: none"> <li>a. Remove the liner on the Card Cleaning Roller before installing the Cartridge, as shown in Display A (upper right arrow of display).</li> <li>b. Remove the Ribbon securing tape, as shown in Display A (middle right arrow of display).</li> </ol>
3	Slide the Ribbon Cartridge into the Printer, as shown in this section.
4	Raise the front Cover and press the front Cover's black rubber pad or touch pad to secure it.

Display A – Shows the Print Ribbon Cartridge before it is installed or inserted into the Printer. The Card Cleaning Roller (see arrow) is already inserted into the Print Ribbon Cartridge.

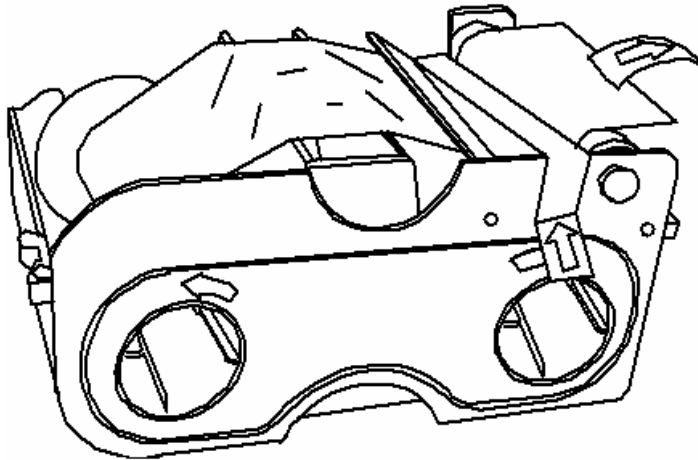

Display B – Shows direction that Cartridge is inserted in the Printer.

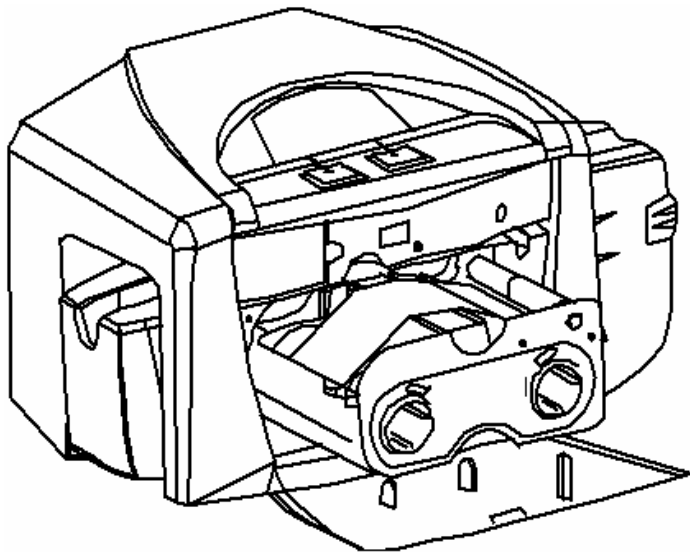



## Installing Blank Cards into the Card Hopper

The DTC400e/C30e/M30e Printer is capable of printing single load cards and multiple feed cards (batch mode).

- To print using single feed, simply remove all cards from the Card Hopper, leave the Card Hopper door closed and place a card in the single Feed Card Slot (which can be used repeatedly).
- Again, the cards should be loaded with the print side down and (if applicable) the magnetic strip up and towards the front of the Printer.

To print using Batch Mode follow the instructions below.

Step	Procedure
1	Open the Card Hopper Cover.
2	Press the Card Hopper Load Lever down until the Card Tray locks into place, as shown in Display B in this section.
3	Load up to 100 cards into the Hopper with the print side down. If using cards with a magnetic stripe, the magnetic stripe should be loaded with the stripe up and to the front of the Printer, as shown in Display C in this section.
4	Close the Card Hopper Cover to release the Card Tray.

Display A – This is a graphics showing how to insert the cards.

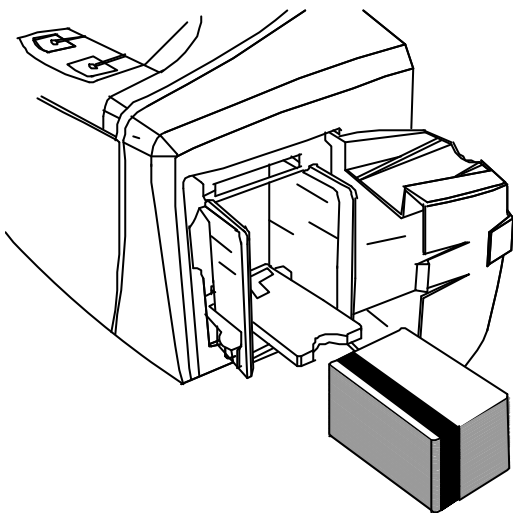

Display B - Press the Card Hopper Load Lever down. Insert the cards.

Here the Lever is still up.

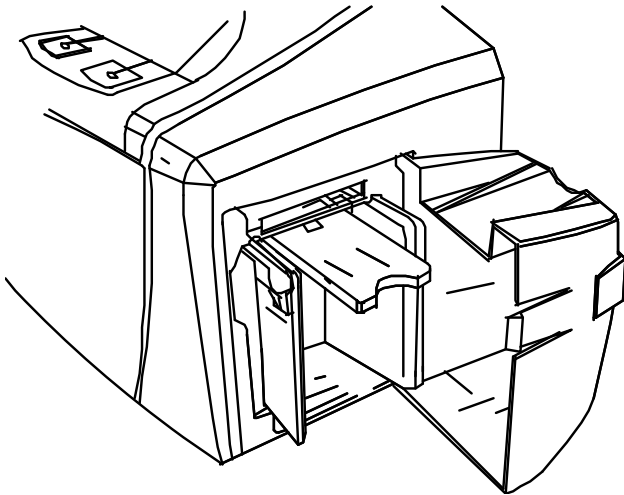

Here the Lever is pressed down.

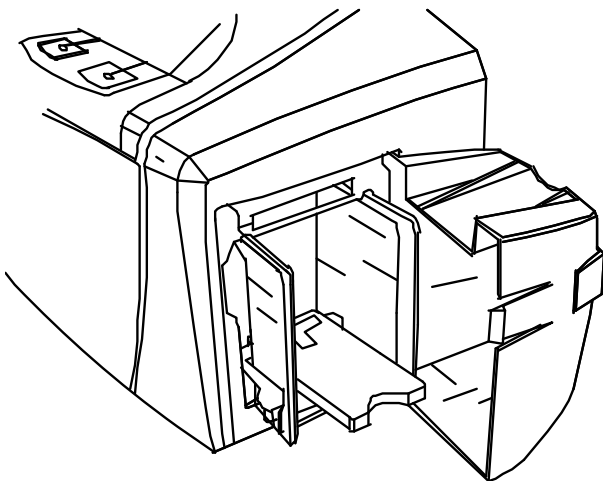

**Here are the cards ready to insert.**

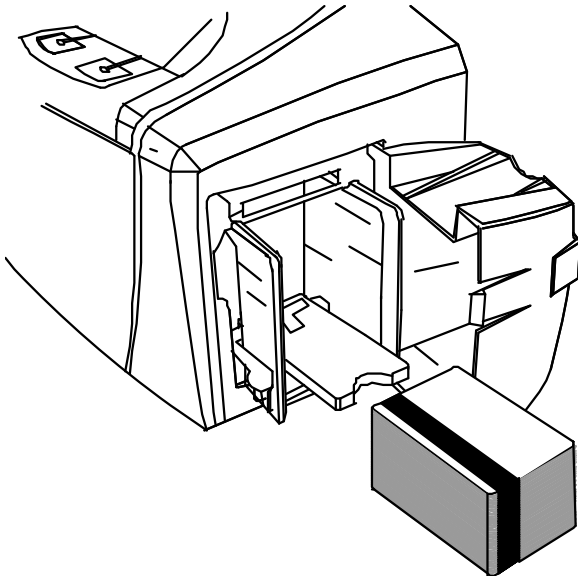

Here the Input Hopper Door is closed.

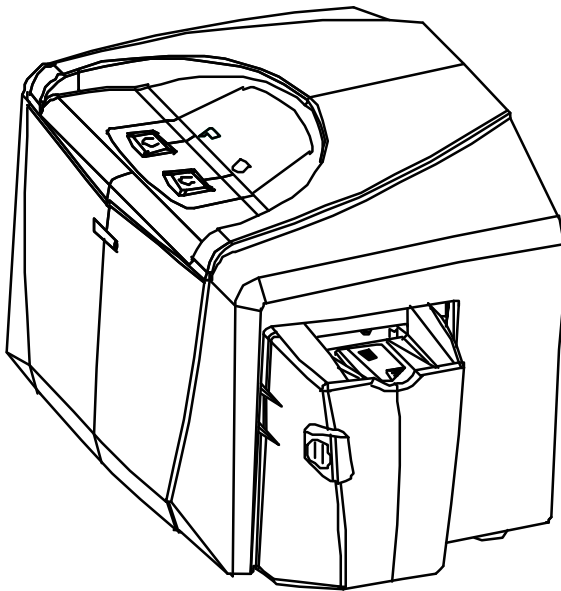

## Lowering the Card Output Hopper

Step	Procedure
1	The DTC400e/C30e/M30e comes with a Card Output Hopper (to hold cards after they have been printed). Pull the Output Hopper down until it snaps into place.

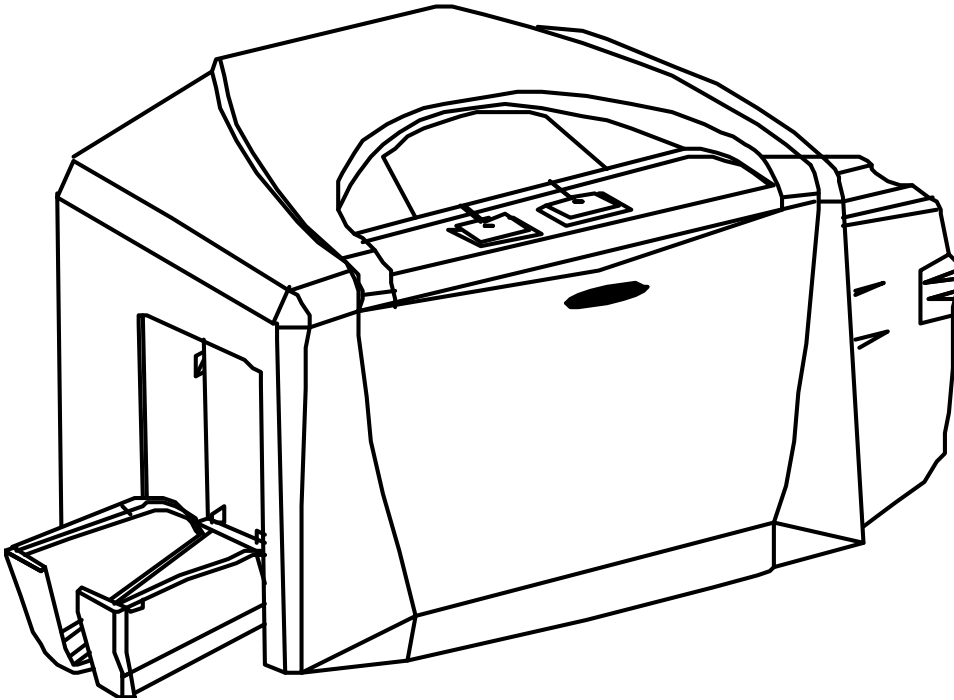

# Printer Driver Installation

Installing the Printer Driver – (C30e shown for this example)

Use the same procedure for M30e and DTC400e Card Printer.

Step	Procedure
1	<p>Close all programs and insert the Software Installation CD into your computer's CD drive. After a few seconds, the CD's installer program will automatically open.</p> <p>Follow the CD's on-screen Procedures to complete installation.</p> <p><b>(Note:</b> If the CD does not automatically open, use My Computer or Windows Explorer to view the contents of the CD. Then, double-click on the Setup.exe file listed on the CD.)</p>
2	<p>Click on the following buttons to install the appropriate Printer Driver and Online User's Guide, as shown below:</p> <p><b>INSTALL the Printer Driver</b> button for the <b>C30e/M30e Card Printer/Encoder</b></p>

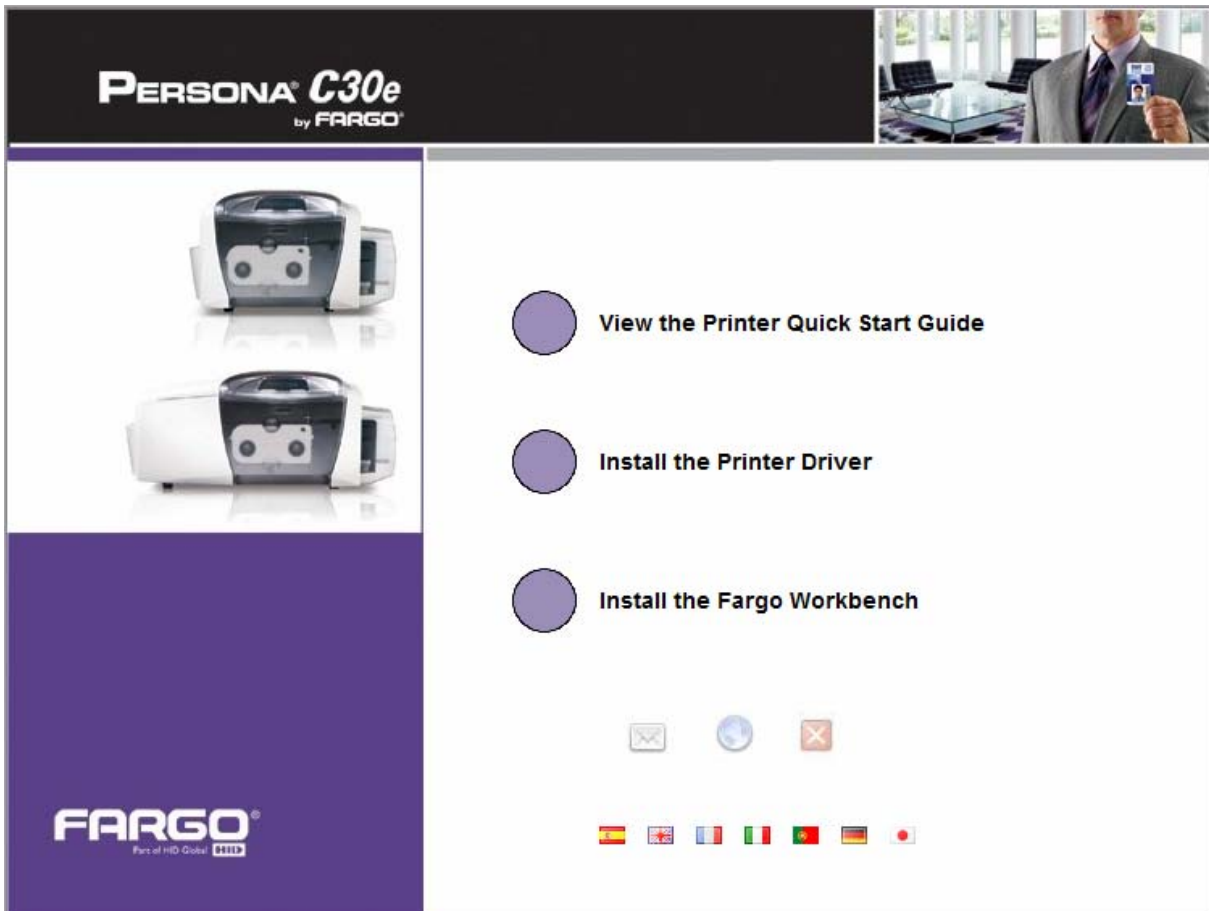

3	Click on the <b>Next</b> button to continue with the Setup program.
---	---

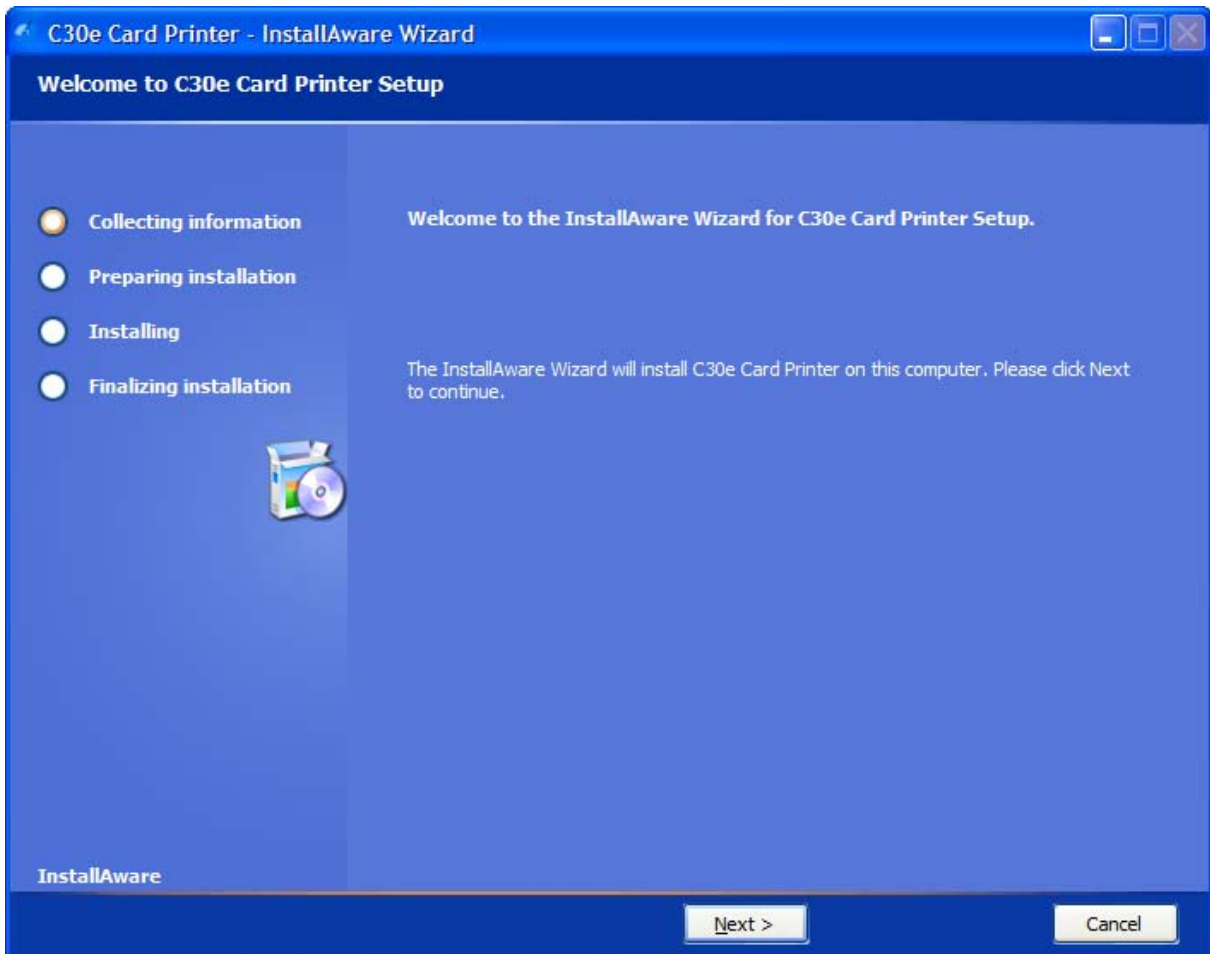

4	Read the License Agreement. Select the <b>I accept the license agreement</b> option and click <b>Next</b> to continue.
---	--

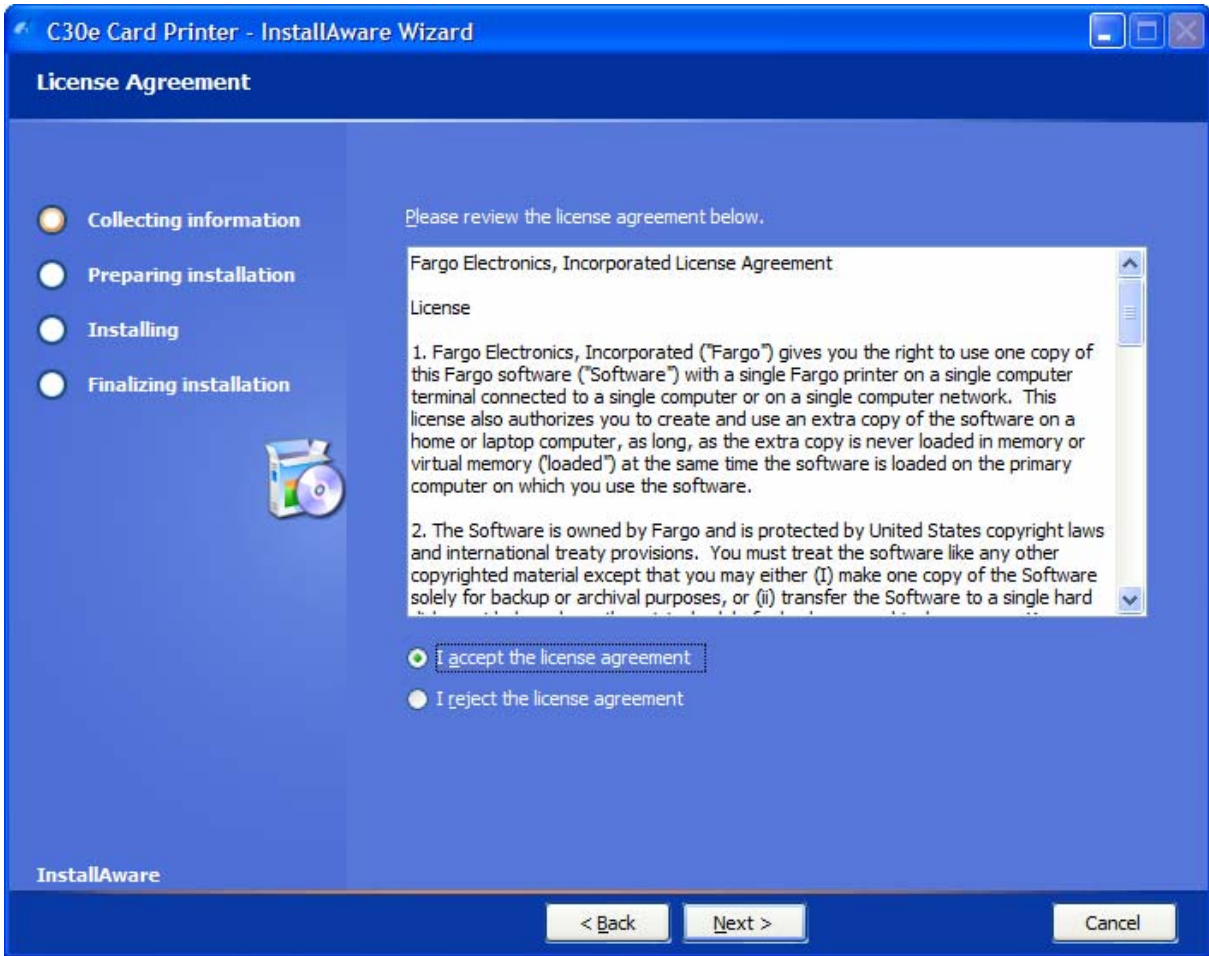

5	<p>Select <b>Local Connection (USB :)</b> if the printer is equipped with a USB port and click <b>Next</b> to continue with the installation.</p> <p><b>OR</b></p> <p>Select <b>Network Connection (Ethernet)</b> if the printer is equipped with an Ethernet port and enter the Printer's IP address. Click <b>Next</b> to continue with the installation.</p>
---	---

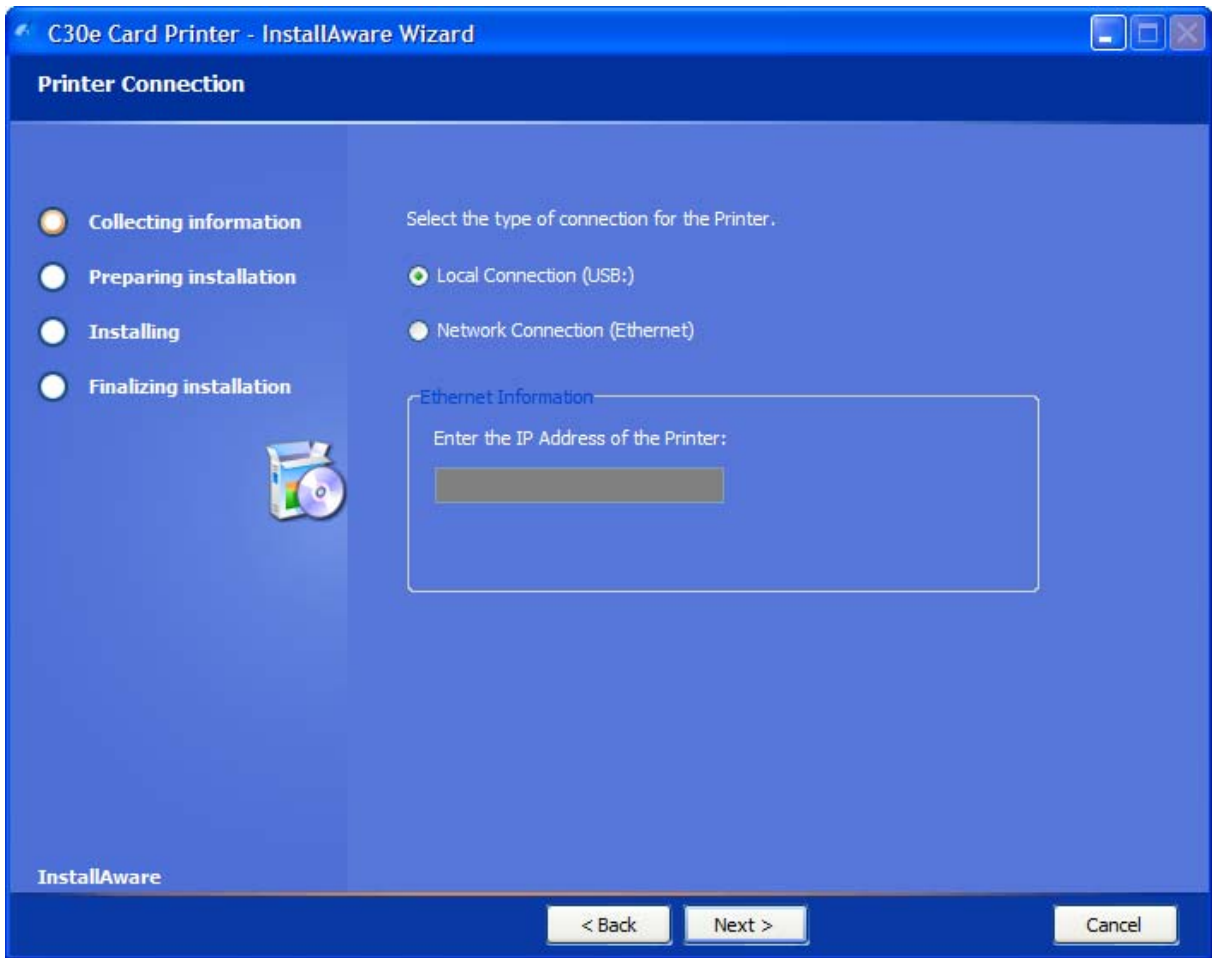

6	Click <b>Next</b> to begin the installation.
---	--



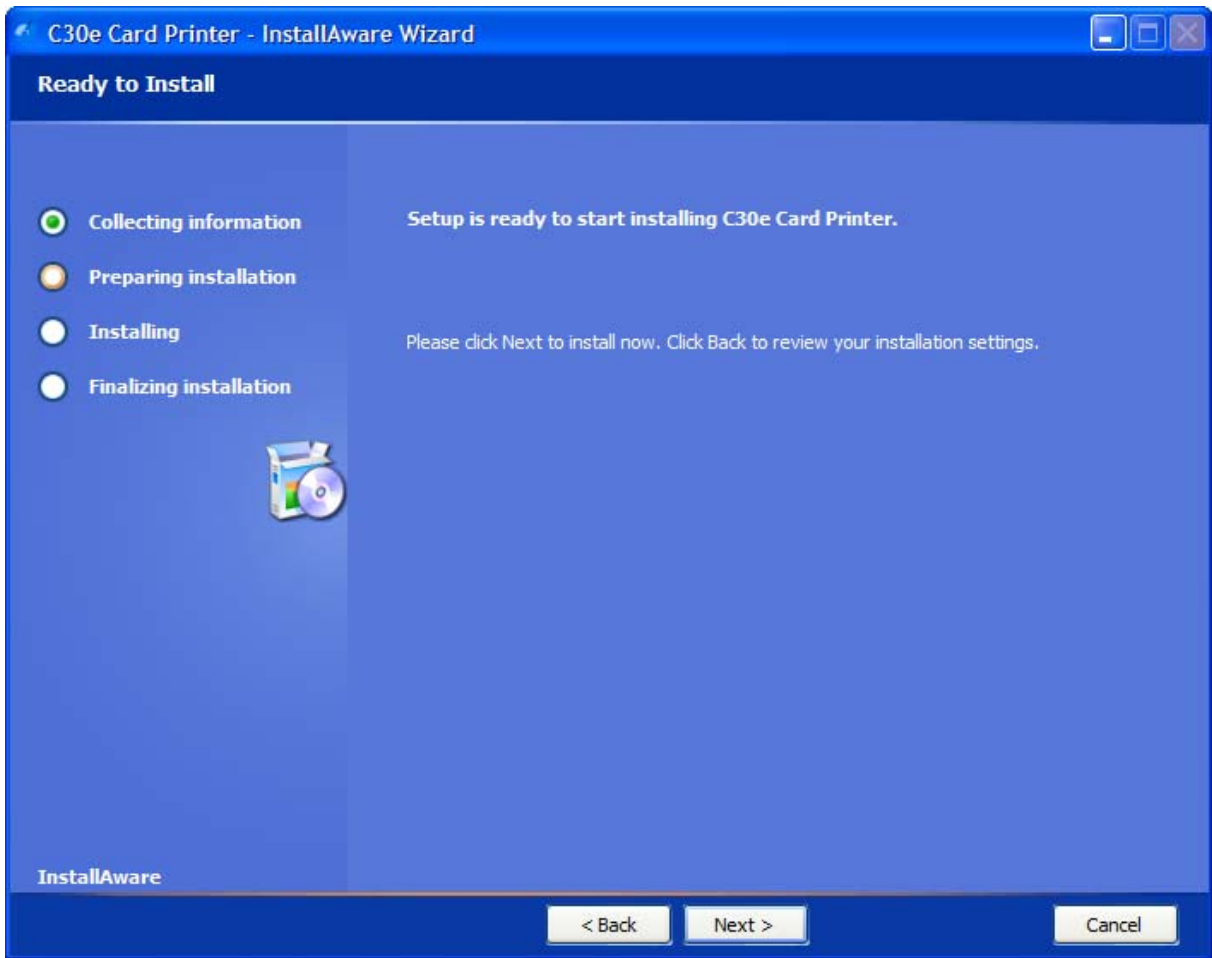

7	Wait while the DTC400e/C30e/M30e Card Printer is configuring your new software installation.
---	--

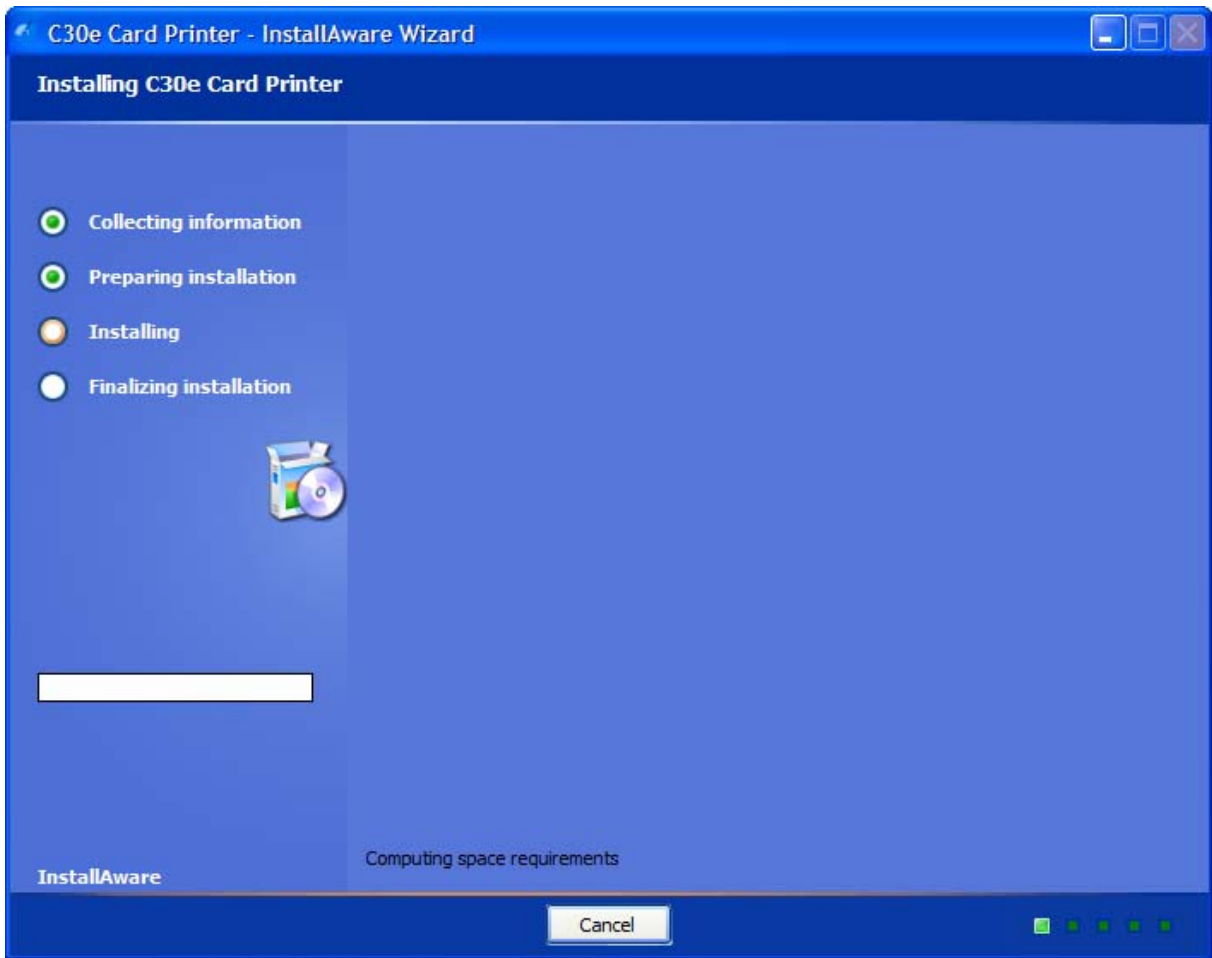

8	<p>This step only applies to local connection installation (USB).</p> <ul style="list-style-type: none"><li>a. Connect the USB cable to the Printer.</li><li>b. Turn ON the Printer at this time if it is not already ON.</li><li>c. Wait during the installation.</li></ul>
---	--

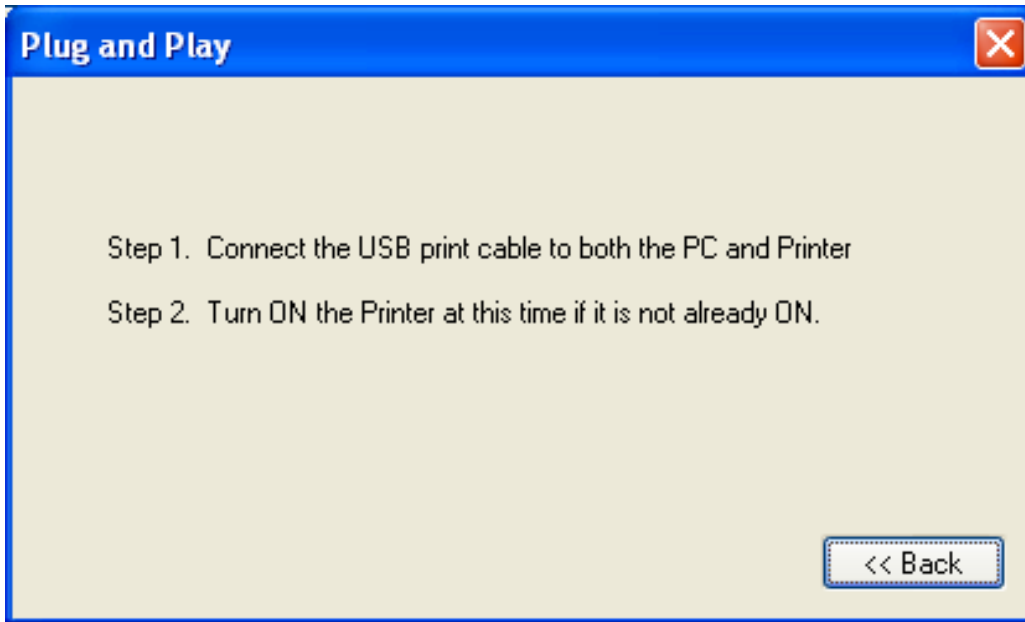

9	Select the installed Ribbon Type.
---	-----------------------------------

DTC400e & C30e

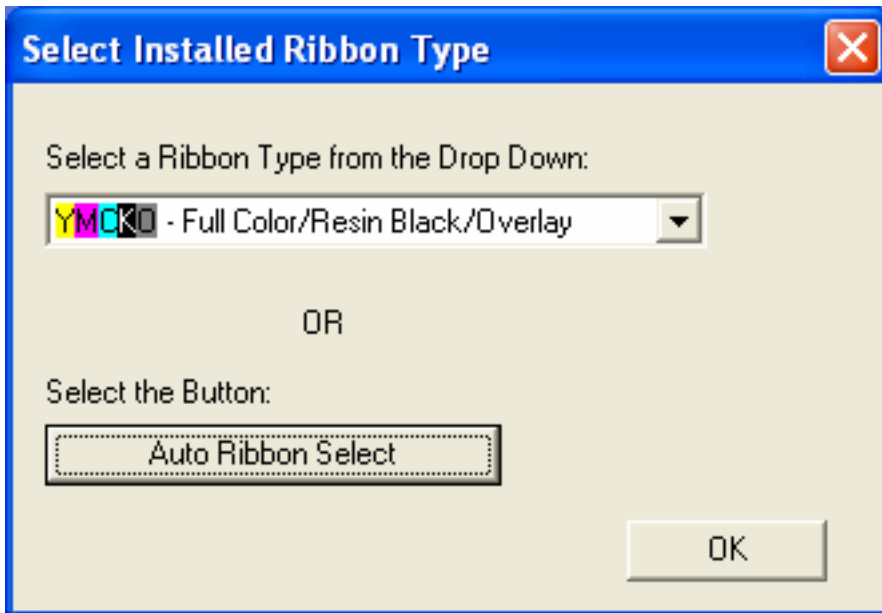

M30e

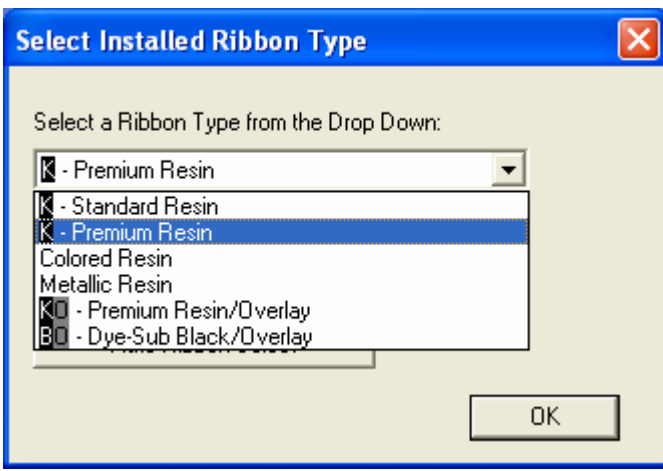
 <p>10</p>	<p>Click on the <b>Finish</b> button to complete the Setup.</p>
---	---

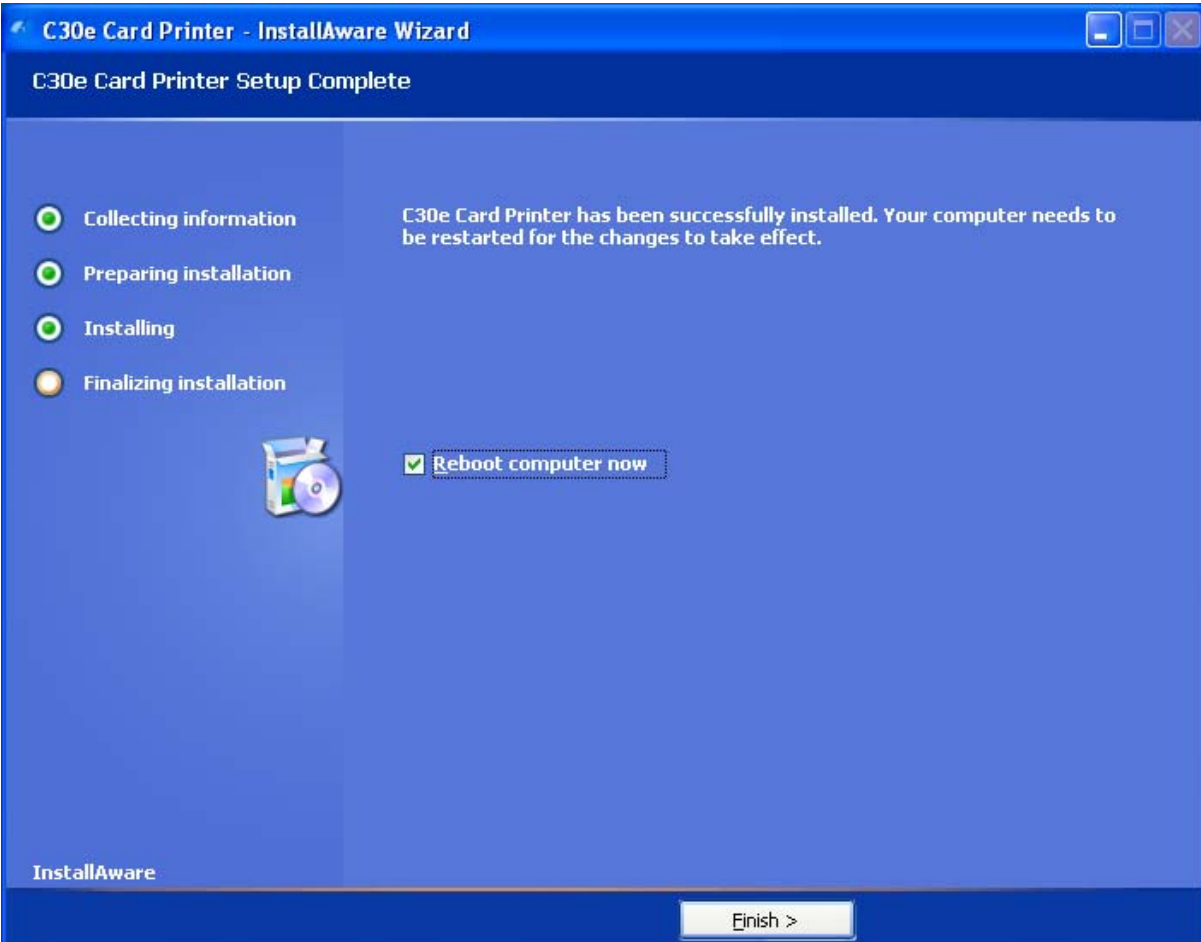

11	<ul style="list-style-type: none"><li>• Click the <b>Exit</b> button to exit the installer, as shown below.</li></ul>
----	---

	<b>OR</b> <ul style="list-style-type: none"><li>Click on <b>Install the Fargo Workbench</b>.</li></ul>
12	<b>You have completed the installation</b>

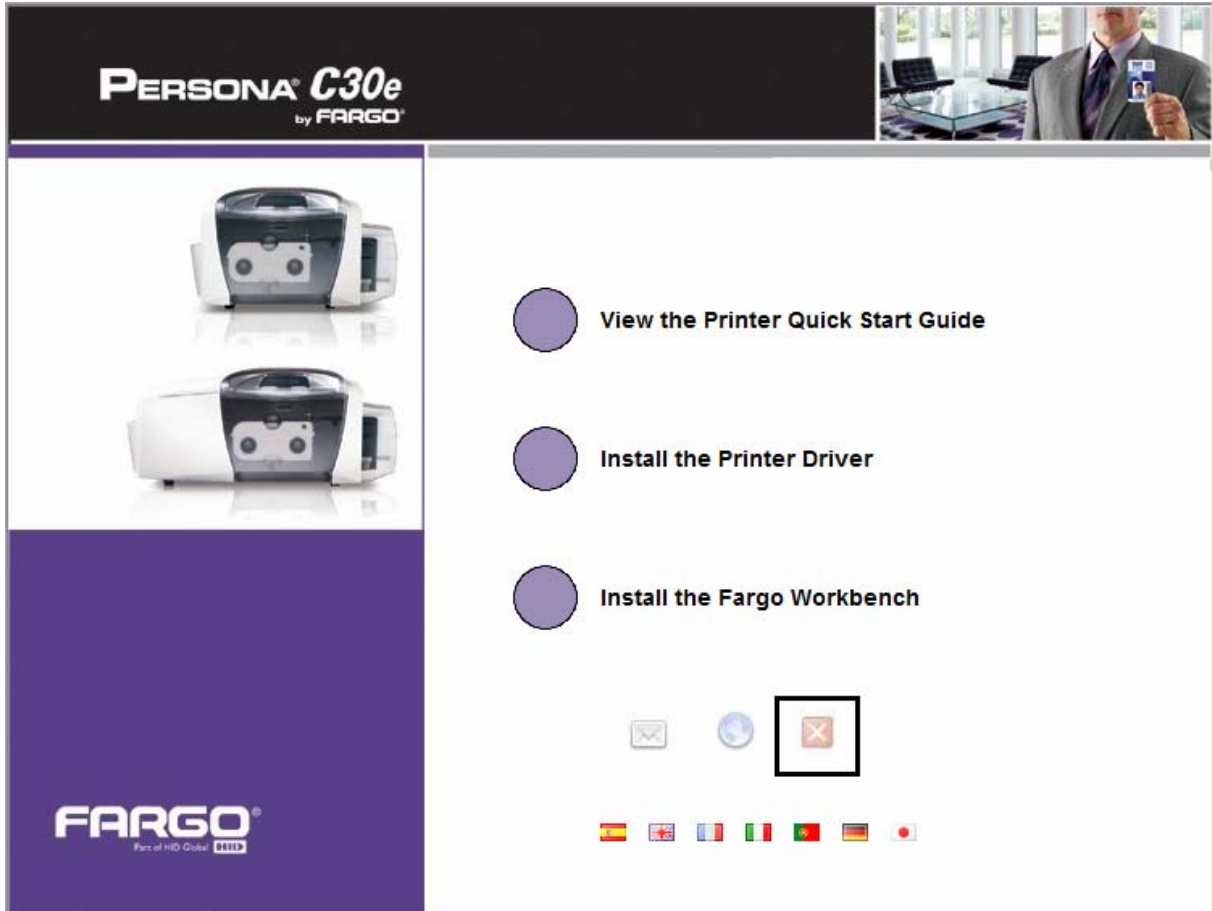

## Printing a Test Print Image

Step	Procedure
1	<ol style="list-style-type: none"> <li>From your computer's startup menu, select Settings &gt; Printers and Faxes (Windows XP, 2003) or &gt; Printers (Windows 2000).</li> <li>Double click on the DTC400e or Persona C30e or M30e Card Printer under the Printers window.</li> <li>Select Printing Preferences under the Printer drop-down menu. This will bring up the Printing Preferences window.</li> </ol>
2	<ol style="list-style-type: none"> <li>Select the Card tab, and then click on the <b>Test Print</b> button, as shown in Display A in this section. (<b>Important:</b> Ensure that the Ribbon is installed before proceeding. The correct Ribbon type is selected in the Device Options tab.)</li> <li>When the <b>Test Print</b> button is selected, an image is copied to the Printer.</li> </ol>

Display A - Persona C30e/M30e Printer Driver Card tab

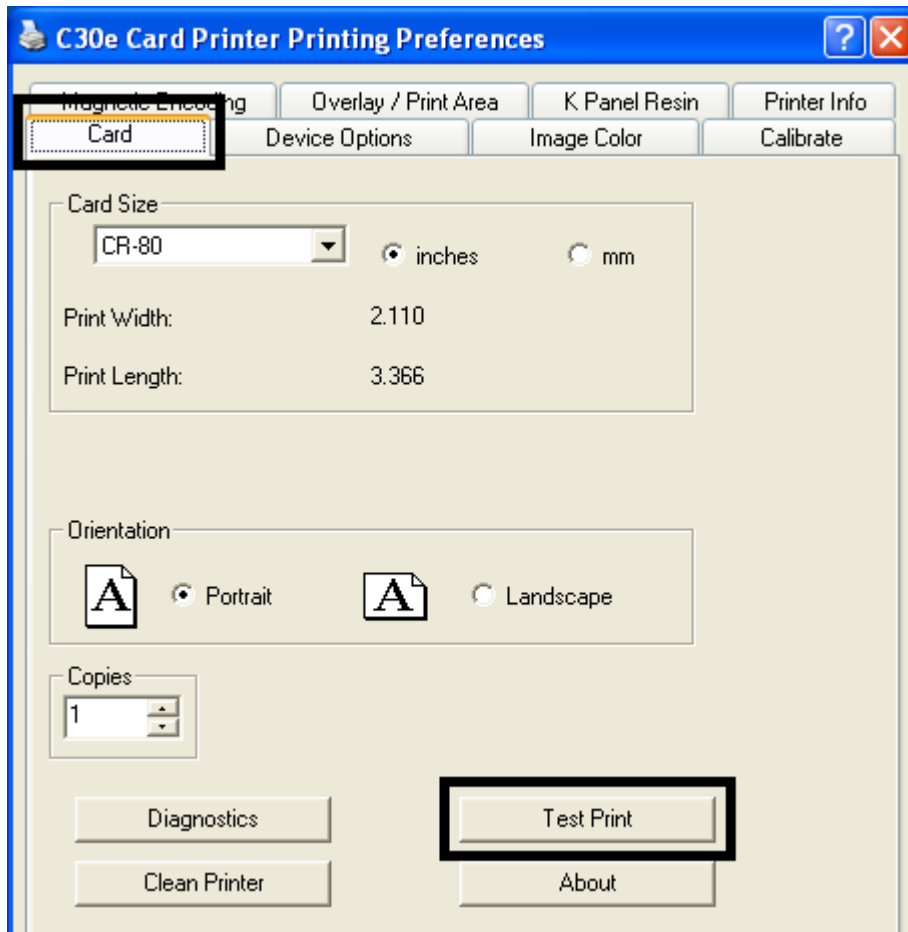

# Printer Transport

Moving the Printer to another location

Step	Procedure
1	The Printer can be transported by gripping it under the back lid, as shown in the photo below.
2	<b>You have completed the setup and installation procedures in this section.</b>

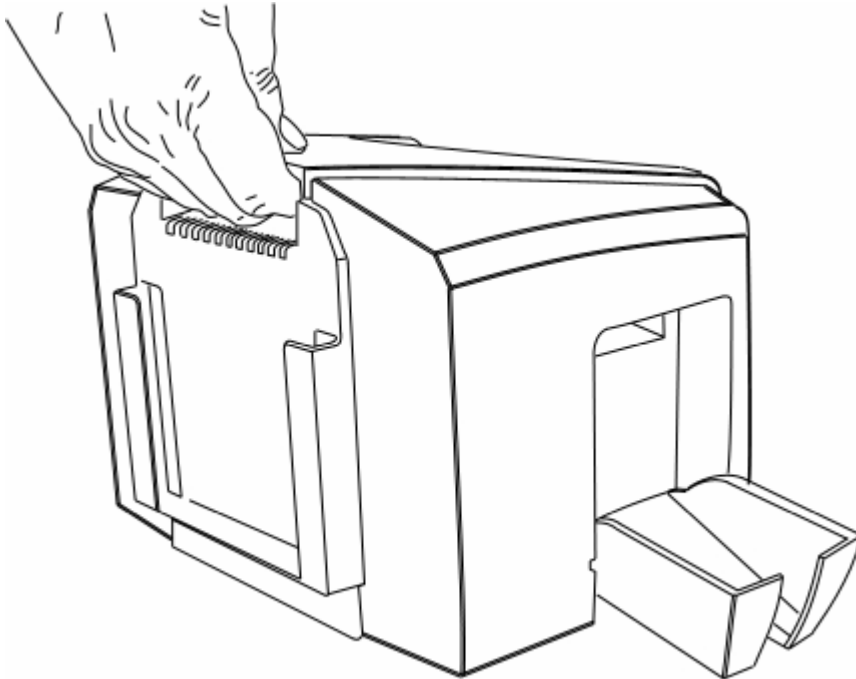



## Section 4: General Troubleshooting

This section provides Troubleshooting procedures for this Printer for Communication Errors, Card Feed Errors, Print Process Errors, Card Jam Errors, Encoding Errors and Diagnosing Image Problems.

**NOTE: ANY PART REPLACEMENT REFERENCES MUST BE DONE BY FARGO AUTHORIZED DEALERS OR FARGO REPAIR DEPARTMENT ONLY.**

### Safety Messages (review carefully)

Symbol	Critical Instructions for Safety purposes
<p><b>Danger:</b></p> 	<p><b>Failure to follow these installation guidelines can result in death or serious injury.</b></p> <p>Information that raises potential safety issues is indicated by a warning symbol (as shown to the left).</p> <ul style="list-style-type: none"> <li>• <b>To prevent personal injury</b>, refer to the following safety messages before performing an operation preceded by this symbol.</li> <li>• <b>To prevent personal injury</b>, always remove the power cord prior to performing repair procedures, unless otherwise specified.</li> <li>• <b>To prevent personal injury</b>, make sure only qualified personnel perform these procedures.</li> </ul>
<p><b>Caution:</b></p> 	<p><b>This device is electrostatically sensitive. It may be damaged if exposed to static electricity discharges.</b></p> <p>Information that raises potential electrostatic safety issues is indicated by a warning symbol (as shown to the left).</p> <ul style="list-style-type: none"> <li>• <b>To prevent equipment or media damage</b>, refer to the following safety messages before performing an operation preceded by this symbol.</li> <li>• <b>To prevent equipment or media damage</b>, observe all established Electrostatic Discharge (ESD) procedures while handling cables in or near the Circuit Board and Printhead Assemblies.</li> <li>• <b>To prevent equipment or media damage</b>, always wear an appropriate personal grounding device (e.g., a high quality wrist strap grounded to avoid potential damage).</li> <li>• <b>To prevent equipment or media damage</b>, always remove the Ribbon and Cards from the Printer before making any repairs, unless otherwise specified.</li> <li>• <b>To prevent equipment or media damage</b>, take jewelry off of fingers and hands, as well as thoroughly clean hands to remove oil and debris before working on the Printer.</li> </ul>



# Communications Errors

## Resolving the Communication Errors

**Symptom(s):** Incorrect output, communications error on PC or Printer, stalling, no response from Printer, no job printed, “paper out” error.

Step	Procedure
1	Confirm that the system meets the minimum requirements, as shown here: <ul style="list-style-type: none"> <li>• IBM-PC or compatible.</li> <li>• Windows 2000/XP Pentium™ class 500 MHz computer with 256 MB of RAM or higher</li> <li>• 500 MB free hard disk space or higher</li> <li>• USB Port</li> </ul>
2	Confirm the correct installation of the Printer Driver. <ol style="list-style-type: none"> <li>a. Close the software program and check the Printer Driver.</li> <li>b. Reboot the computer.</li> <li>c. Ensure the Printer Driver is installed correctly. (<b>Note:</b> Especially if an obsolete Driver was recently removed.)</li> <li>d. Ensure the correct setup options within the Printer Driver are selected.</li> <li>e. Confirm that the Driver is current by checking at: <a href="http://www.fargo.com">www.fargo.com</a></li> </ol>
3	Confirm the correct installation of the Flipper Table Module Assembly. <ol style="list-style-type: none"> <li>a. Reboot the computer.</li> <li>b. Ensure that the <b>Print Both Sides</b> option in the Printer Driver is set correctly.</li> <li>c. Verify the Flipper Table Module Assembly is functioning properly by printing out cards in a test run.</li> <li>d. If you are experiencing problems, see Resolving the No Flipper Table Module problem.</li> </ol>
4	Determine the problem with printing from the application. <ol style="list-style-type: none"> <li>a. Print a self-test from the Printer by holding down the <b>Pause</b> button on power up to ensure that the Printer (itself) is functioning properly.</li> <li>b. Print the Windows test page that is located in the General tab of the Driver.</li> <li>c. Use <b>WordPad</b> (a Windows word processing program in the Accessories Program Group).               <ol style="list-style-type: none"> <li>1) Go to the <b>File</b> menu and select <b>Page Setup</b>.</li> </ol> </li> </ol>

	<ol style="list-style-type: none"><li>2) Click on the <b>Printer</b> button and select the Persona C30e/M30e Card Printer.</li><li>3) Click <b>OK</b> and reset all four margins to zero. (<b>Note:</b> The WordPad will automatically replace the values with its minimum margins.)</li><li>4) Open the program and type: "This is a Test." then, go to <b>File</b> on the menu bar and select <b>Print</b>.</li></ol>
5	<p>Determine whether there is adequate hard Drive space.</p> <p>(<b>Note:</b> A large volume of temporary files on the computer can cause communications errors.)</p> <ol style="list-style-type: none"><li>a. Access the temporary files by following this process:<ul style="list-style-type: none"><li>• Search for all folders called TEMP. Once found, clear out the contents of the folders.</li><li>• If using Windows 2000/XP, run the System Utility - Disk Defragmenter found in the Accessories folder of the <b>Start</b> Menu.</li><li>• Use a disk cleanup utility (such as <b>Disk Cleanup</b> found in the System Tools folder of the Start menu) or use a third party application.</li></ul></li></ol>

## Print Process Errors

All Troubleshooting procedures assume that only factory-authorized supplies are in use in the Printer.

### Resolving a Card Not Fed Error (Cards will not feed off the Hopper)

Step	Procedure
1	<p>Review the following information.</p> <ul style="list-style-type: none"> <li>• <b>Symptom:</b> Cards will not feed at all.</li> <li>• <b>Printer Error State:</b> Card is not being detected by the Card TOF Sensor 11 seconds after the initiation of a print job causing the Printer to produce an error.</li> <li>• <b>Driver Monitor Error Display:</b> Unable to Feed Card</li> </ul>



2	<p>Check the card quality / loading.</p> <ol style="list-style-type: none"> <li>a. Remove cards from the Card Hopper.</li> <li>b. Ensure that the cards are not sticking together by fanning them out and then lining them back together in a straight deck.</li> <li>c. Press the Card Hopper Load Lever down until the Card Tray locks into place.</li> <li>d. Load up to 100 cards into the Hopper with the print side down.</li> <li>e. Close the Card Hopper Cover to release the Card Tray.</li> <li>f. Press on the <b>Resume</b> button.</li> <li>g. If the cards do not feed, continue to Step 3.</li> </ol>
3	<p>Press the <b>Cancel Print</b> button on the Driver Monitor Error Display Message.</p>
4	<p>Reboot the Printer by cycling the power.</p>
5	<p>Check the Card Feed Motor.</p> <ol style="list-style-type: none"> <li>a. Remove all cards from the Hopper.</li> <li>b. Press the Card Hopper Load Lever down until the Card Tray locks into place.</li> <li>c. Use the Fargo Workbench Printer Utility to send a test print to the Printer.</li> <li>d. Gently touch the Card Hopper Feed Roller to verify that it is turning</li> <li>e. If Roller is NOT turning, continue to Step 7.</li> <li>f. If Roller is turning, continue to Step 6.</li> </ol>
6	<p>Check Hopper Tray Spring Tension.</p> <ol style="list-style-type: none"> <li>a. Open Card Hopper Cover.</li> <li>b. Use the Fargo Workbench Printer Utility to send a test print to the Printer.</li> <li>c. When the Card Hopper Feed Roller engages, push up on the Card Hopper Tray.</li> <li>g. If the cards feed, replace the Card Hopper Lift Spring.</li> <li>d. If the cards do not feed, replace the Card Hopper Feed Roller.</li> </ol>
7	<p>Card Hopper Feed Roller is not turning during a print job.</p> <ol style="list-style-type: none"> <li>a. Remove the Printer rear cover.</li> <li>b. Ensure that the Card Hopper Feed Motor power cable is securely connected to J-20 on the Printers Main Board.</li> <li>c. Ensure that the Card Hopper Feed Motor power cable is securely connected to the Card Hopper Feed Motor.</li> <li>d. Use the Fargo Workbench Printer Utility to send a test print to the Printer.</li> <li>e. If the Card Hopper Feed Motor is not moving, continue to Step 8.</li> </ol>

8	<p>Replace Card Hopper Feed Motor.</p> <ol style="list-style-type: none"><li>a. Replace the Card Hopper Feed Motor.</li><li>b. Use the Fargo Workbench Printer Utility to send a test print to the Printer.</li><li>c. If the Card Hopper Feed Motor does not turn, replace the Main Board.</li></ol>
---	---

## Resolving a Card Not Fed Error (Two (2) or more cards feed at the same time)

All Troubleshooting procedures assume that only factory-authorized supplies are in use in the Printer.

Step	Procedure
1	<p>Review the following information.</p> <ul style="list-style-type: none"><li>• <b>Symptoms:</b> Two or more cards feed at the same time causing the cards to jam at the Card Hopper Roller. Printer is out of cards.</li><li>• <b>Printer Error State:</b> Card is not being detected by card TOF Sensor 11 sec after the initiation of a print job causing the Printer to produce an error.</li><li>• <b>Driver Monitor Error Display:</b> Unable to Feed Card</li></ul>



2	<p>Check card quality / loading.</p> <ol style="list-style-type: none"><li>a. Remove cards from the Card Hopper.</li><li>b. Ensure that the cards are not sticking together by fanning them out and then lining them back together in a straight deck.</li><li>c. Press the Card Hopper Load Lever down until the Card Tray locks into place.</li><li>d. Load up to 100 cards into the Hopper with the print side down.</li><li>e. Close the Card Hopper Cover to release the Card Tray.</li><li>f. Press on the <b>Resume</b> button.</li><li>g. If the cards do not feed, continue to Step 3.</li></ol>
3	Press the <b>Cancel Print</b> button on the Driver Monitor Error Display Message.
4	Reboot the Printer by cycling the power.
5	<p>Check Card Feed TOF Sensor.</p> <ol style="list-style-type: none"><li>a. Remove the Printers rear cover.</li><li>b. Use a digital volt meter to place the Positive lead to pin 9 of the J-4 Main Board connection and the negative lead to pin 12 of the J-4 Main Board connection.<ul style="list-style-type: none"><li>• The blocked Sensor should read +4.99 vdc.</li><li>• The open Sensor should read +1.5 vdc.</li></ul></li><li>c. If the Card Feed TOF Sensor does not read properly, replace the Sensor.</li></ol>
6	Clean the Card Feed Roller.

## Resolving a Ribbon RFID Error (Ribbon RFID Antenna is Corrupted)

All Troubleshooting procedures assume that only factory-authorized supplies are in use in the Printer.

Step	Procedure
1	<p>Review the following information.</p> <ul style="list-style-type: none"> <li>• <b>Symptom:</b> Printer RFID Sensor does not detect a recognizable signal from the Ribbon.</li> <li>• <b>Printer Error State:</b> The Ribbon tag information is corrupted or incorrect.</li> <li>• <b>Driver Monitor Error Display:</b> Ribbon RFID Error</li> </ul>

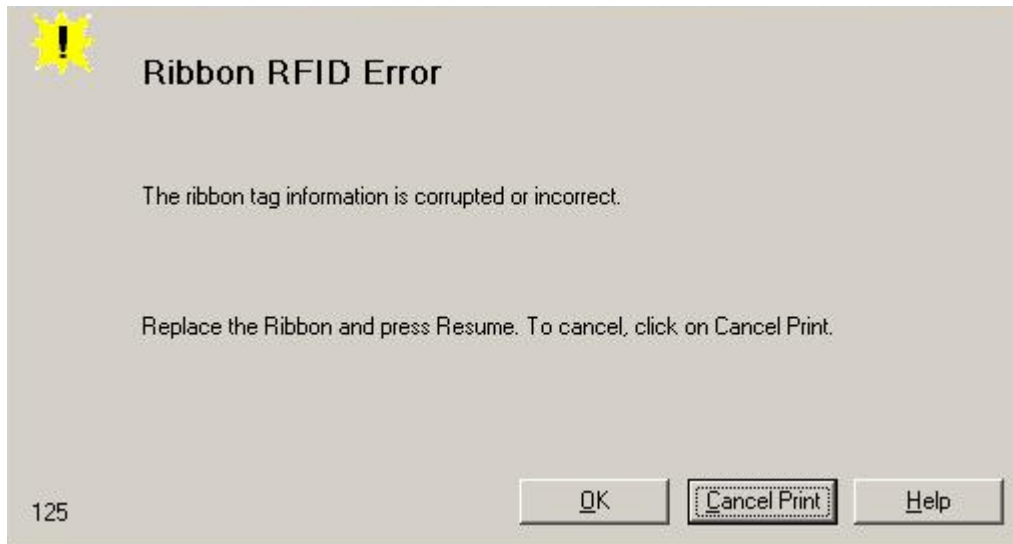

2	<p>Replace the Print Ribbon</p> <ol style="list-style-type: none"> <li>a. Replace the Print Ribbon Cartridge.</li> <li>b. Press on the <b>Resume</b> button.</li> <li>c. If the error continues, replace the Printer Main Board.</li> </ol>
---	---



## Resolving the Mag Verify Error

All Troubleshooting procedures assume that only factory-authorized supplies are in use in the Printer.

Step	Procedure
1	<p>Review the following information.</p> <ul style="list-style-type: none"> <li>• <b>Symptom:</b> The Printer is unable to verify encoded data.</li> <li>• <b>Printer Error State:</b> The Printer is unable to verify encoded data.</li> <li>• <b>Driver Monitor Error Display:</b> Mag Verify Error</li> </ul>

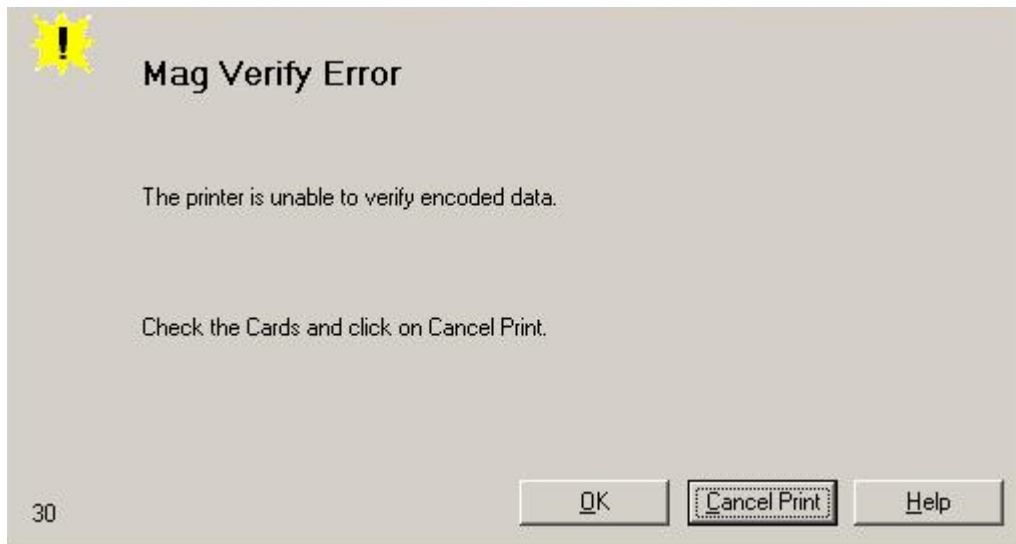

2	Check to ensure that the cards are loaded with the Magnetic Stripe facing Up and towards the front of the Printer.
3	<ol style="list-style-type: none"> <li>a. Press on the <b>Resume</b> button.</li> <li>b. If the error continues continue to step 4</li> </ol>
4	Verify the Driver settings if cards are loaded properly. See the Using the Magnetic Encoding tab (Persona C30e/M30e) procedure.
5	<p>Verify that data is being encoded to the Magnetic Stripe.</p> <ol style="list-style-type: none"> <li>a. Clear any Error Messages by unplugging the Printer and reapplying power.</li> <li>b. Remove the failed card.</li> <li>c. Use a Magnetic Stripe reader or magnetic developer spray to determine if</li> </ol>

	<p>data is being written to the Magnetic Stripe.</p> <p>d. If data is not being written to the Magnetic Stripe,</p> <ul style="list-style-type: none"> <li>• Open the front cover.</li> <li>• Verify that the Magnetic Module is seated securely into the Magnetic Module docking station.</li> </ul> <p>e. If the Magnetic Module is properly seated, replace the magnetic head (as needed). (<b>Note:</b> in the Parts Replacement Section.)</p> <p>f. If data is being written to the Magnetic Stripe, the Magnetic Offset may need to be adjusted. See the Using the Mag Top of Form Option procedure.</p>
<p>6</p>	<p>Verify that the coercivity of the cards matches the Driver Settings.</p>

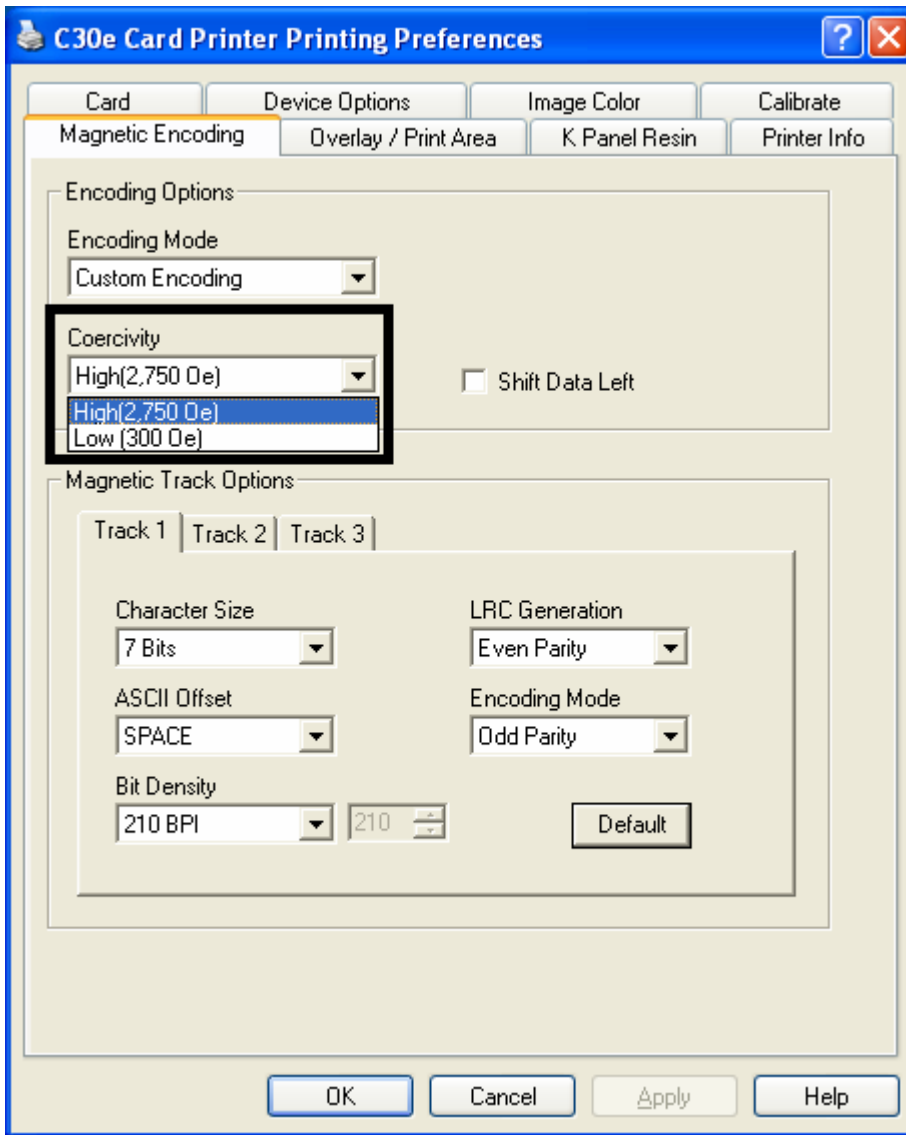

## Resolving the No Magnetic Encoder Installed Error

All Troubleshooting procedures assume that only factory-authorized supplies are in use in the Printer.

Step	Procedure
1	<p>Review the following information.</p> <ul style="list-style-type: none"> <li>• <b>Symptom:</b> There is not a Magnetic Encoder installed.</li> <li>• <b>Printer Error State:</b> A print job with Magnetic encoding was sent with no Magnetic encoder installed in the Printer.</li> <li>• <b>Driver Monitor Error Display:</b> No Magnetic Encoder Installed</li> </ul>

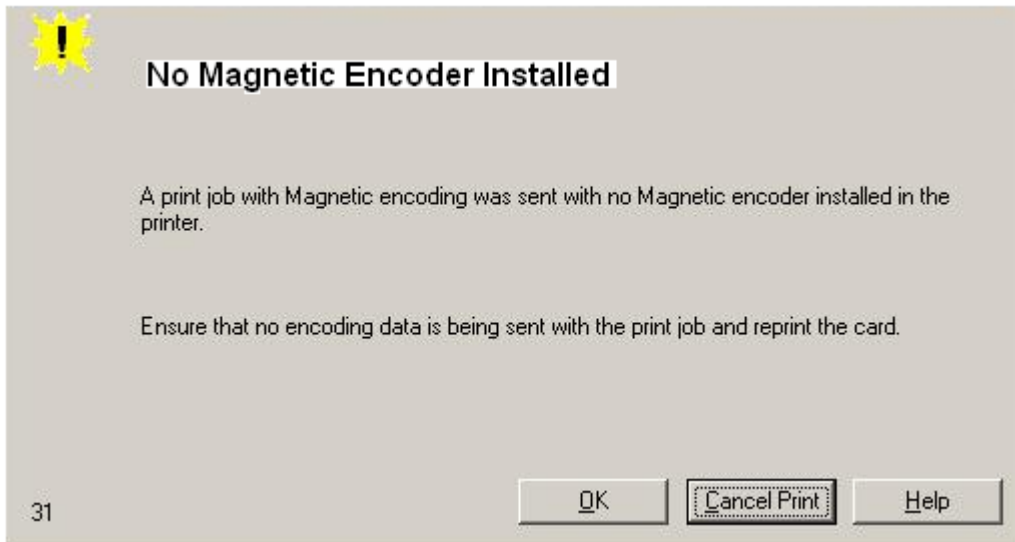

2	Press the <b>Cancel Print</b> button on the Driver Monitor Error Display Message.
3	Reboot the Printer by cycling the power.
4	<p>Verify that the Printer has a Magnetic Encoder installed.</p> <ol style="list-style-type: none"> <li>a. Open the front cover.</li> <li>b. Verify that the Printer has a Magnetic Module installed. (<b>Note:</b> If the Printer is equipped with a Magnetic Encoder Module, ensure that it is seated securely into the Magnetic Module docking station. If the issue persists, replace the Magnetic Module. See the Persona C30e/M30e service manual for replacement procedures.)</li> </ol>
5	If the Printer has no Magnetic Encoder Module, verify that the encoding data

	was sent in error, check the appropriate software user's manual for encoding instructions.
--	--

## Resolving the No Mag Stripe Present Error

All Troubleshooting procedures assume that only factory-authorized supplies are in use in the Printer.

Step	Procedure
1	<p>Review the following information.</p> <ul style="list-style-type: none"><li>• <b>Symptom:</b> There is no magnetic card in the printer.</li><li>• <b>Printer Error State:</b> A print job with Magnetic encoding data was sent to the printer but the card does not have a magnetic stripe on it.</li><li>• <b>Driver Monitor Error Display:</b> No Mag Strip Present</li></ul>
2	<ul style="list-style-type: none"><li>• Verify card has magnetic stripe and it is placed in the hopper correctly. Magnetic stripe must face UP.</li></ul>



## Resolving the No Smart Card Encoder Error

All Troubleshooting procedures assume that only factory-authorized supplies are in use in the Printer.

Step	Procedure
1	Review the following information. <ul style="list-style-type: none"> <li>• <b>Symptom:</b> There is not a Smart Card Encoder installed.</li> <li>• <b>Printer Error State:</b> A print job with Smart Card encoding was sent with no encoder installed in the Printer.</li> <li>• <b>Driver Monitor Error Display:</b> No Smart Card Encoder Installed</li> </ul>
2	Press the <b>Cancel Print</b> button on the Driver Monitor Error Display Message.
3	Reboot the Printer by cycling the power.
4	Verify that the Printer has a Smart Card Encoder installed. <ol style="list-style-type: none"> <li>c. Open the front cover.</li> <li>d. Verify that the Printer has a Smart Card Module installed. (<b>Note:</b> If the Printer is equipped with a Smart Card Encoder Module, ensure that it is seated securely into the Module docking station. If the issue persists, replace the Smart Card Module. See the Persona C30e/M30e service manual for replacement procedures.)</li> </ol>
5	If the Printer has no Smart Card Encoder Module, verify that the encoding data was sent in error, check the appropriate software user's manual for encoding instructions.

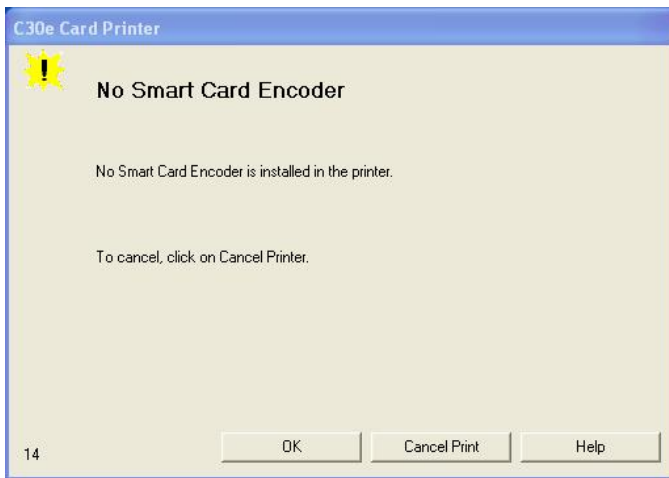



## Resolving the No Prox Card Encoder Error

All Troubleshooting procedures assume that only factory-authorized supplies are in use in the Printer.

Step	Procedure
1	Review the following information. <ul style="list-style-type: none"> <li>• <b>Symptom:</b> There is not a Prox Card Encoder installed.</li> <li>• <b>Printer Error State:</b> A print job with Prox Card encoding was sent with no encoder installed in the Printer.</li> <li>• <b>Driver Monitor Error Display:</b> No Prox Card Encoder Installed</li> </ul>
2	Press the <b>Cancel Print</b> button on the Driver Monitor Error Display Message.
3	Reboot the Printer by cycling the power.
4	Verify that the Printer has a Prox Card Encoder installed. <ol style="list-style-type: none"> <li>e. Open the front cover.</li> <li>f. Verify that the Printer has a Prox Card Module installed. (<b>Note:</b> If the Printer is equipped with a Prox Card Encoder Module, ensure that it is seated securely into the Module docking station. If the issue persists, replace the Prox Card Module. See the Persona C30e/M30e service manual for replacement procedures.)</li> </ol>
5	If the Printer has no Prox Card Encoder Module, verify that the encoding data was sent in error, check the appropriate software user's manual for encoding instructions.

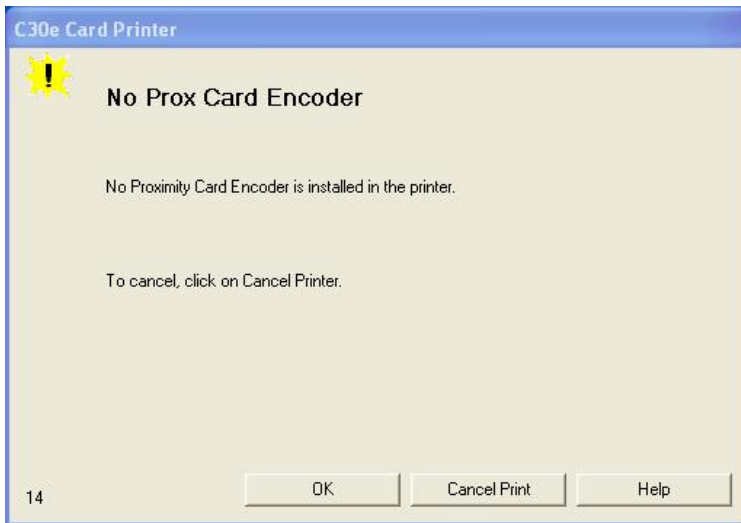

## Resolving a Ribbon Sensor Error (Ribbon Miscue) DTC400e & C30e

All Troubleshooting procedures assume that only factory-authorized supplies are in use in the Printer. (**Note:** Using the printer in direct sunlight may adversely affect the ribbon sensor integrity.)

Step	Procedure
1	<p>Review the following information.</p> <ul style="list-style-type: none"> <li>• <b>Symptom:</b> The Printer rolls through Ribbon and errors out.</li> <li>• <b>Printer Error State:</b> The Printer cannot find the next panel on the Ribbon.</li> <li>• <b>Driver Monitor Error Display:</b> Ribbon Sensor Error</li> </ul>

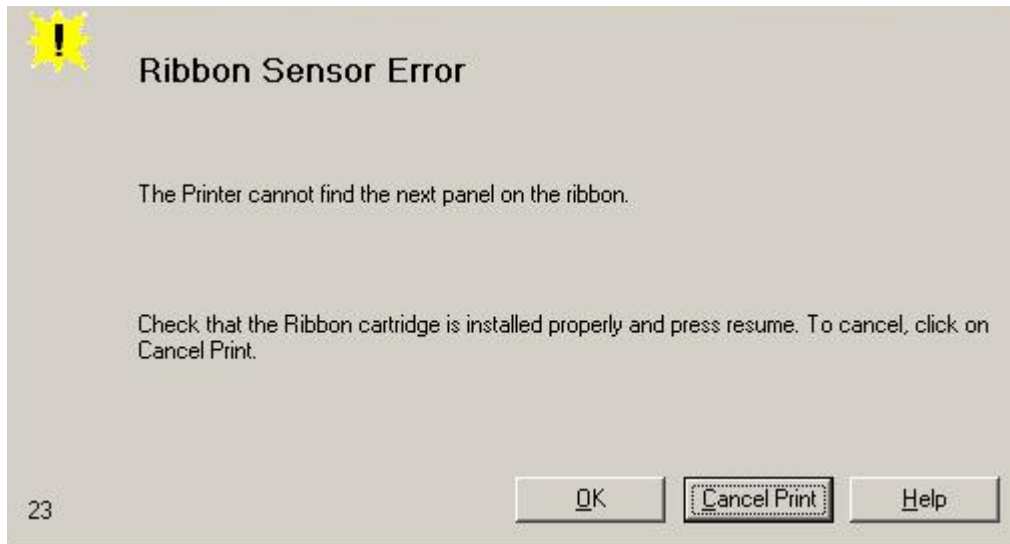

2	<p>Open the front cover and remove the Ribbon Cartridge.</p> <ol style="list-style-type: none"> <li>a. Check that the Ribbon is in good condition and not wrinkled or broken.</li> <li>b. If Ribbon is broke or wrinkled, repair the Ribbon and wind up the take-up roll 4-color panels past the damaged area.</li> </ol>
3	<p>Press on the <b>Resume</b> button.</p> <p>If the issue persists, continue to Step 4.</p>

4	<p>Replace the Ribbon Cartridge.</p> <ol style="list-style-type: none"> <li>a. Press on the <b>Resume</b> button.</li> <li>b. If the issue persists, continue to Step 5.</li> </ol>
5	Press the <b>Cancel Print</b> button on the Driver Monitor Error Display Message.
6	Reboot the Printer by cycling the power.
7	<p>Use the Driver Calibration tab to calibrate the Ribbon Sensor. Cover the front of the printer to block the light while calibrating this sensor.</p> <ul style="list-style-type: none"> <li>• If the issue persists, continue to Step 8.</li> </ul>
8	Replace the Ribbon Sensor.

## Resolving a Ribbon Break Jam Error

All Troubleshooting procedures assume that only factory-authorized supplies are in use in the Printer. (**Note:** Using the printer in direct sunlight may adversely affect the ribbon sensor integrity.)

Step	Procedure
1	<p>Review the following information.</p> <ul style="list-style-type: none"> <li>• <b>Symptom:</b> The Print Ribbon has become jammed or has broken in the Printer.</li> <li>• <b>Printer Error State:</b> The Ribbon Supply Encoder Sensor has unexpectedly stop receiving information from the Ribbon Encoder</li> <li>• <b>Driver Monitor Error Display:</b> Ribbon Break/Jam</li> </ul>

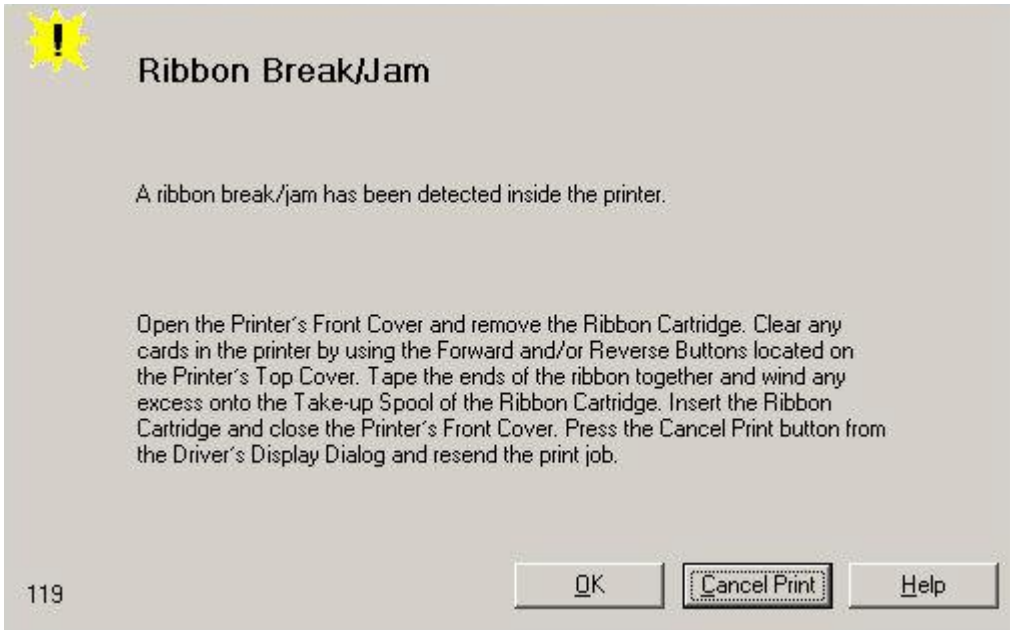

2	<p>Open the front cover and remove the Ribbon Cartridge.</p> <ul style="list-style-type: none"> <li>• If Ribbon is broken, continue to Step 3.</li> <li>• If Ribbon is in good condition, continue to Step 6.</li> </ul>
3	<p>Adjust the print offset. See the <u>Using the Print Top of Form Option</u> procedure. If the issue persists, continue to Step 4.</p>
4	<p>Repair the Ribbon and wind up the take-up roll 4 color panels past the damaged area.</p> <ol style="list-style-type: none"> <li>a. Press on the <b>Resume</b> button.</li> <li>b. If the issue persists, continue to Step 5.</li> </ol>
5	<p>Use the Fargo Workbench Printer Utility to cycle the Printhead to ensure proper Printhead operation.</p> <ul style="list-style-type: none"> <li>• If the Printhead does not cycle properly, see Resolving the Headlift Motor / Sensor Error.</li> <li>• If the Printhead functions properly, continue to Step 6.</li> </ul>
6	<p>Replace the Ribbon Cartridge.</p> <ol style="list-style-type: none"> <li>a. Press on the <b>Resume</b> button.</li> <li>b. If the issue persists, continue to Step 7.</li> </ol>

7	<p>Remove the rear cover in order to check that the Ribbon Encoder Sensor is securely connected to the J-4 Main Board connection and to the Encoder Sensor.</p> <ol style="list-style-type: none"><li>a. Press on the <b>Resume</b> button.</li><li>b. If the issue persists, replace the Encoder Sensor.</li></ol>
---	---

## Resolving a Ribbon Out Error

All Troubleshooting procedures assume that only factory-authorized supplies are in use in the Printer. (**Note:** Using the printer in direct sunlight may adversely affect the ribbon sensor integrity.)

Step	Procedure
1	Review the following information. <ul style="list-style-type: none"> <li>• <b>Symptom:</b> Printer will not print.</li> <li>• <b>Printer Error State:</b> The Ribbon Sensor has detected the End of Ribbon mark.</li> <li>• <b>Driver Monitor Error Display:</b> Ribbon Out</li> </ul>
2	Replace the Ribbon Cartridge <ol style="list-style-type: none"> <li>a. Press on the <b>Resume</b> button.</li> </ol>

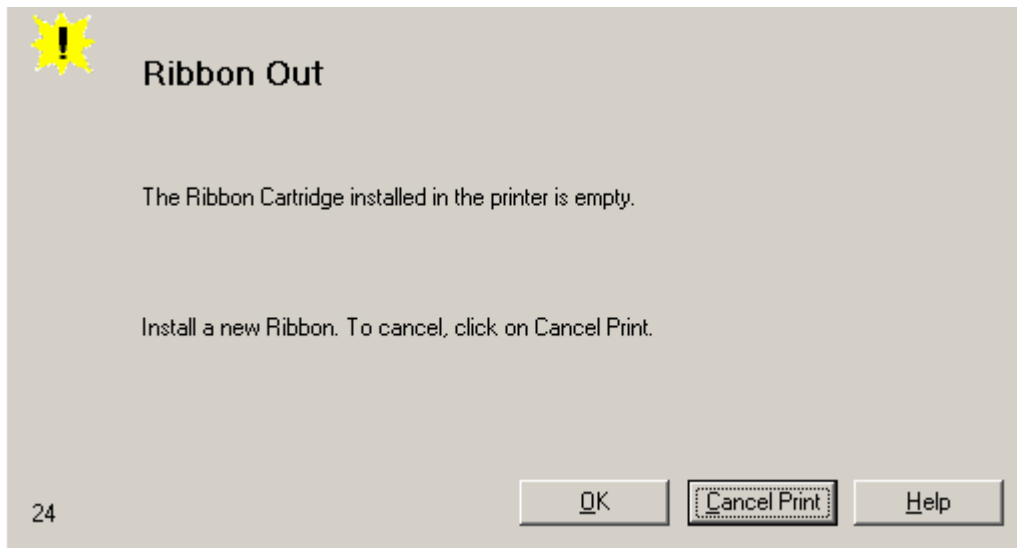

## Resolving a No Ribbon Installed Error

All Troubleshooting procedures assume that only factory-authorized supplies are in use in the Printer.

Step	Procedure
1	<p>Review the following information.</p> <ul style="list-style-type: none"> <li>• <b>Symptom:</b> Printer errors out as soon as it receives data from PC.</li> <li>• <b>Printer Error State:</b> The Printer RFID Sensor is not receiving a signal from the Ribbon.</li> <li>• <b>Driver Monitor Error Display:</b> No Ribbon Installed</li> </ul>



2	<p>Verify that a Ribbon Cartridge is installed in the Printer.</p> <ol style="list-style-type: none"> <li>a. Press on the <b>Resume</b> button.</li> <li>b. If the issue persists, continue to Step 3.</li> </ol>
3	<p>Remove the rear cover and check that the Ribbon RFID cable is securely connected to the Main Board (J-5) and the RFID Sensor.</p> <ul style="list-style-type: none"> <li>• If the connections are loose, reattach them.</li> <li>• Press on the <b>Resume</b> button.</li> <li>• If the connections are good or if the issue persists, continue to Step 4.</li> </ul>
4	<p>Replace the Ribbon RFID Sensor.</p>



## Resolving a Invalid Ribbon Error

All Troubleshooting procedures assume that only factory-authorized supplies are in use in the Printer.

Step	Procedure
1	<p>Review the following information.</p> <ul style="list-style-type: none"> <li>• <b>Symptom:</b> Printer errors out as soon as it receives data from the PC.</li> <li>• <b>Printer Error State:</b> The Ribbon installed does not match the Printer model.</li> <li>• <b>Driver Monitor Error Display:</b> Invalid Ribbon</li> </ul>

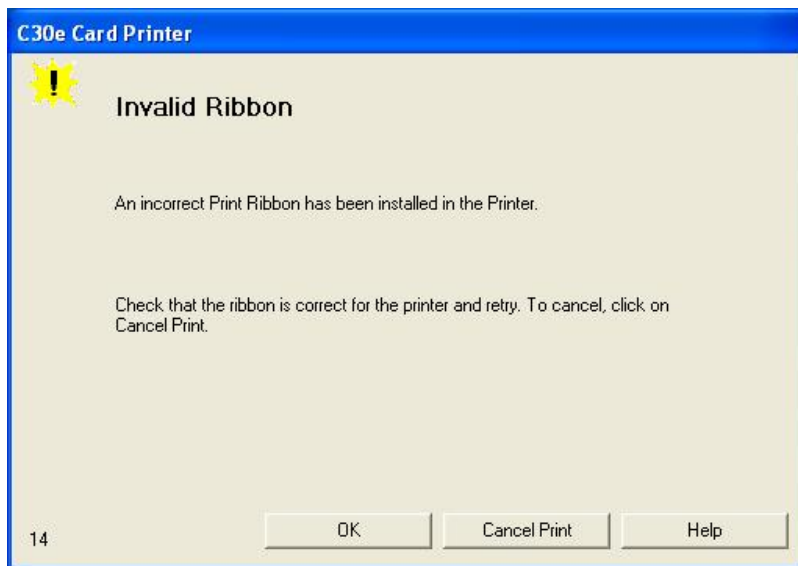

2	Verify that the Ribbon Cartridge installed is designed for the correct Printer model.
3	<p>Press on the <b>Resume</b> button.</p> <p>If the issue persists, continue to Step 4.</p>
4	<p>Remove the rear cover and check that the Ribbon RFID cable is securely connected to the Main Board (J-5) and the RFID Sensor.</p> <ul style="list-style-type: none"> <li>• If the connections are loose, reattach.</li> </ul>

	<ul style="list-style-type: none"><li>• Press on the <b>Resume</b> button.</li><li>• If the connections are good or if the issue persists, continue to Step 5.</li></ul>
5	Replace the Ribbon RFID Sensor.

## Resolving a Wrong Ribbon Error

All Troubleshooting procedures assume that only factory-authorized supplies are in use in the Printer.

Step	Procedure
1	<p>Review the following information.</p> <ul style="list-style-type: none"> <li>• <b>Symptom:</b> Printer errors out as soon as it receives data from the PC.</li> <li>• <b>Printer Error State:</b> The Ribbon installed does not match the Printer Driver information.</li> <li>• <b>Driver Monitor Error Display:</b> Wrong Ribbon Installed</li> </ul>

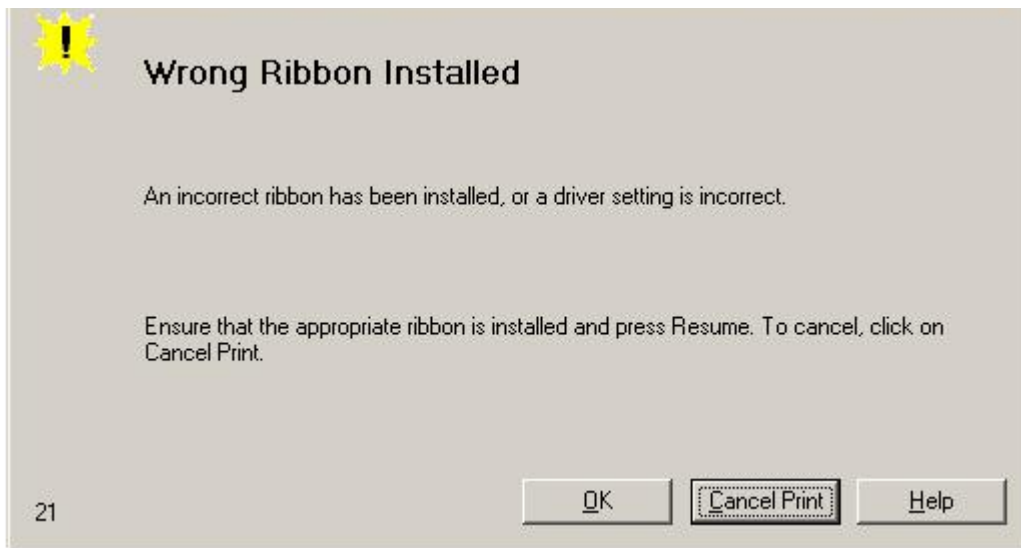

2	<p>Verify the Driver settings are correct.</p> <ol style="list-style-type: none"> <li>a. Open the Printer Control Panel from the Computer. <ul style="list-style-type: none"> <li>• If using Windows 2000/XP, right click on the DTC400e/C30e/M30e Card Printer and select <b>Printing Preferences</b>.</li> </ul> </li> <li>b. Click on the Device Option tab.</li> <li>c. Click on the <b>auto select</b> button.</li> <li>d. Check that the Ribbon type matches the Ribbon selected.</li> </ol>
3	<p>Press on the <b>Resume</b> button.</p> <p>If the issue persists, continue to Step 4.</p>

4	<p>Remove the rear cover and check that the Ribbon RFID cable is securely connected to the Main Board (J-5) and the RFID Sensor.</p> <ul style="list-style-type: none"><li>• If the connections are loose, reattach it.</li><li>• Press on the <b>Resume</b> button.</li><li>• If the connections are good or if the issue persists, continue to Step 5.</li></ul>
5	Replace the Ribbon RFID Sensor.

## Resolving a Card Jam Error

All Troubleshooting procedures assume that only factory-authorized supplies are in use in the Printer.

Step	Procedure
1	<p>Review the following information.</p> <ul style="list-style-type: none"> <li>• <b>Symptom:</b> Card is jammed.</li> <li>• <b>Printer Error State:</b> Card TOF Sensor is detecting no card motion.</li> <li>• <b>Driver Monitor Error Display:</b> Card Jam</li> </ul>

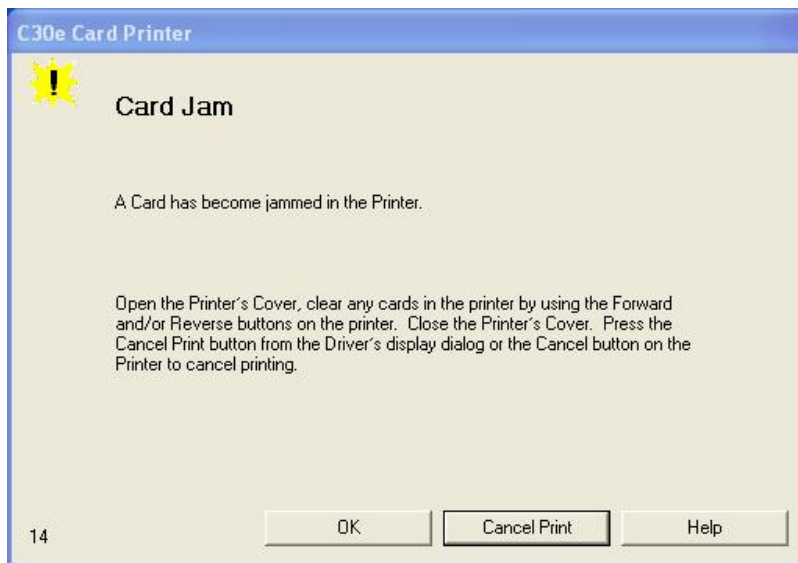

2	<p>Look for a jammed card in the Printer.</p> <ol style="list-style-type: none"> <li>a. Open the Printer's front cover.</li> <li>b. Remove the Ribbon Cartridge from the Printer.</li> <li>c. Check to see if a card is jammed in the print station of the Printer.</li> <li>d. If a card is found in the print station, continue to Step 3.</li> <li>e. If no card was found in the print station, continue to Step 4.</li> </ol>
3	<p>Clearing a jammed card.</p> <ol style="list-style-type: none"> <li>a. If a card is jammed in the Printer, use the <b>Cancel button</b> and the <b>Pause button</b> to move the Feed Rollers and free the card.</li> <li>b. The card can then be fed out of the Printer.</li> </ol>

4	<p>Test the Card Sensor.</p> <ol style="list-style-type: none"><li>a. Remove the rear cover.</li><li>b. Using a Digital Voltmeter, connect the negative lead to ground.</li><li>c. Connect the positive lead to Pin 10 of J4.<ul style="list-style-type: none"><li>• If <b>blocked</b>, the Sensor should read 4.9 to 5.5 VDC.</li><li>• If <b>unblocked</b>, the Sensor should read 0.15 to 0.18 VDC.</li></ul></li><li>d. If the voltages do not read correctly, replace the Sensor. (<b>Note:</b> Contact an authorized repair center)</li></ol>
---	---

## Resolving a Card Jam (Encoder) Error

All Troubleshooting procedures assume that only factory-authorized supplies are in use in the Printer.

Step	Procedure
1	<p>Review the following information.</p> <ul style="list-style-type: none"> <li>• <b>Symptom:</b> Card is jammed in the Printer Encoding Station</li> <li>• <b>Printer Error State:</b> Card TOF Sensor is detecting no card motion.</li> <li>• <b>Driver Monitor Error Display:</b> Card Jam (Encoder)</li> </ul>

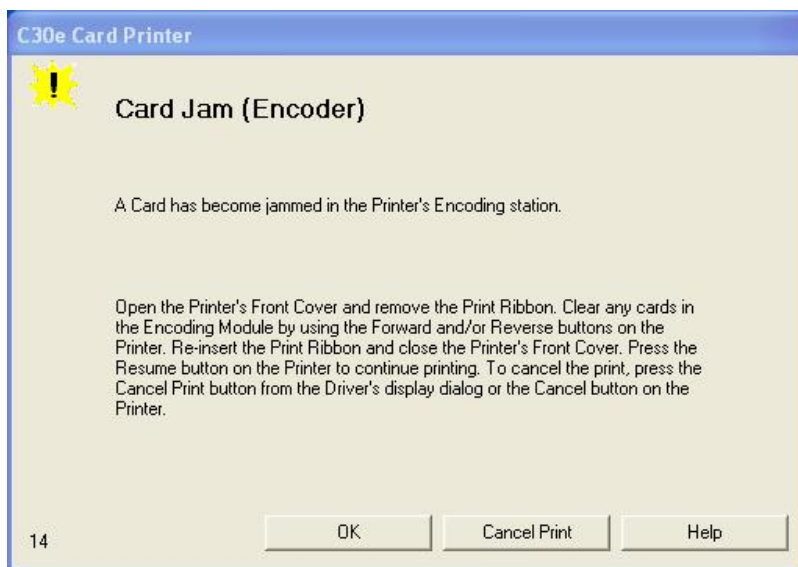

Step	Procedure
2	<ol style="list-style-type: none"> <li>a. Look for a jammed card in the Printer.</li> <li>b. Open the Printer's front cover.</li> <li>c. Remove the Ribbon Cartridge from the Printer.</li> <li>d. Check to see if a card is jammed in the encoding station of the Printer.</li> </ol>
3	<p>Clearing a jammed card.</p> <ol style="list-style-type: none"> <li>a. If a card is jammed in the station, use the <b>Forward button</b> and/or <b>Reverse button</b> to move the Feed Rollers and free the card.</li> <li>b. Re-insert the ribbon and close the printer cover.</li> <li>c. Press the Resume button to continue printing.</li> </ol>

	d. To cancel the print, press the Cancel button from the Driver dialog or Cancel the button on the Printer.
4	<p>Test the Card Sensor.</p> <p>e. Remove the rear cover.</p> <p>f. Using a Digital Voltmeter, connect the negative lead to ground.</p> <p>g. Connect the positive lead to Pin 10 of J4.</p> <ul style="list-style-type: none"><li>• If <b>blocked</b>, the Sensor should read 4.9 to 5.5 VDC.</li><li>• If <b>unblocked</b>, the Sensor should read 0.15 to 0.18 VDC.</li></ul> <p>h. If the voltages do not read correctly, replace the Sensor. (<b>Note:</b> Contact an authorized repair center)</p>



## Resolving a Headlift Motor or Sensor Error

All Troubleshooting procedures assume that only factory-authorized supplies are in use in the Printer.

Step	Procedure
1	<p>Review the following information.</p> <ul style="list-style-type: none"> <li>• <b>Symptom:</b> The Printhead continuously cycles or does not cycle at all.</li> <li>• <b>Printer Error State:</b> Headlift Sensor is not detecting movement from the Headlift Cam.</li> <li>• <b>Driver Monitor Error Display:</b> Headlift Error</li> </ul>

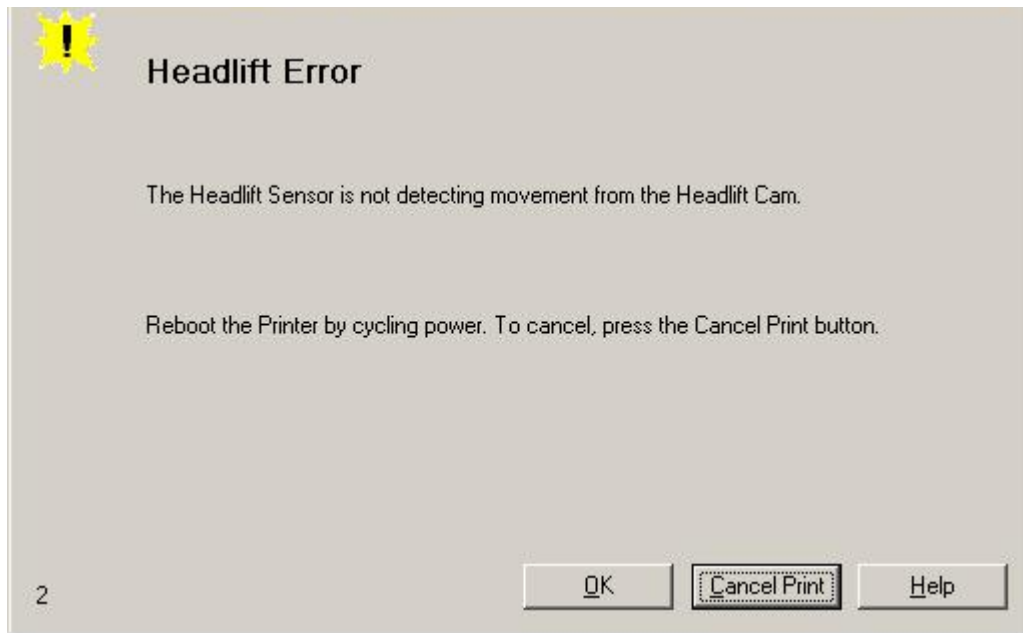

2	Press the <b>Cancel Print</b> button on the Driver Monitor Error Display Message.
3	Reboot the Printer by cycling the power.
4	<p>Cycle the Headlift Motors.</p> <ol style="list-style-type: none"> <li>a. Use the Fargo Diagnostic utility to cycle the Printhead to ensure proper printhead operation.</li> <li>a. Verify that the Headlift Motor turns.</li> </ol>

	b. If the Motor does not turn or jams, continue to Step 5.
5	<p>Check the Headlift Motor Main Board Connection (J20).</p> <ol style="list-style-type: none"> <li>Unplug the Printer.</li> <li>Remove the back cover.</li> <li>Verify that connection J20 is properly connected to the Main Board.</li> <li>If the Motor does not turn, continue to Step 7.</li> </ol>
6	<p>Test the Headlift Sensor.</p> <ol style="list-style-type: none"> <li>Remove the back cover.</li> <li>Attach the positive lead from a Digital Voltmeter to Pin 1 of J9. Attach the negative lead to the Pin 3 of J9. <ul style="list-style-type: none"> <li>• If <b>open</b>, the Sensor should read 0.17 to 0.9 VDC.</li> <li>• If <b>closed</b>, the Sensor should read 4.9 to 5.5 VDC.</li> </ul> </li> <li>Replace the Sensor if the voltages do not read correctly. (<b>Note:</b> Contact an authorized repair center)</li> <li>If the Motor does turn, continue to Step 7.</li> </ol>
7	<p>Replace the Headlift Motor (<b>Note:</b> Contact an authorized repair center)</p> <ol style="list-style-type: none"> <li>If the Motor does turn, continue to Step 8.</li> </ol>
8	Replace the Main Board. ( <b>Note:</b> Contact an authorized repair center)

## Resolving the Cover Open issue

All Troubleshooting procedures assume that only factory-authorized supplies are in use in the Printer.

Step	Procedure
1	Review the following information. <ul style="list-style-type: none"> <li>• <b>Symptom:</b> The Printer remains idle after a print job is sent.</li> <li>• <b>Printer Error State:</b> The front cover Sensor detects that the cover is open.</li> <li>• <b>Driver Monitor Error Display:</b> None</li> </ul>
2	Check for debris, as follows: <ol style="list-style-type: none"> <li>a. Open the front cover and check that no debris has accumulated in the Sensor opening. Use compressed air to clean the opening as needed.</li> <li>b. If the Sensor still does not work, continue to Step 3.</li> </ol>
3	Check that the Sensor tab on the front cover is not damaged. <ol style="list-style-type: none"> <li>a. Open the front cover and examine the Lid Sensor tab for damage, if the Sensor tab is damaged, replace the front cover. (<b>Note:</b> in the Parts Replacement Section.)</li> <li>b. If the Sensor still does not work, continue to Step 4.</li> </ol>
4	Replace the Main Board. . ( <b>Note:</b> Contact an authorized repair center)

## Resolving the Blank Output issues

All Troubleshooting procedures assume that only factory-authorized supplies are in use in the Printer.

Step	Procedure
1	Review the following information. <ul style="list-style-type: none"> <li>• <b>Symptom:</b> A card is ejected blank (that should be printed).</li> <li>• <b>Printer Error State:</b> None</li> <li>• <b>Driver Monitor Error Display:</b> None</li> </ul>
2	Run a self-test. <ol style="list-style-type: none"> <li>a. Clear any card jams.</li> <li>b. Unplug power from the Printer.</li> <li>c. While holding down the <b>Pause</b> button, reapply power.</li> </ol> <p>(<b>Note:</b> A self-test card will be printed.)</p>
3	Look for an image on the Ribbon. <ol style="list-style-type: none"> <li>a. After a self-test has been run, open the front cover.</li> <li>b. Remove the Print Ribbon from the Printer.</li> <li>c. Visually inspect the set of panels that were last used by the Printer.</li> <li>d. If an image is noticeable on the used Ribbon, continue to Step 4.</li> <li>e. If an image is not noticeable on the used Ribbon, continue to Step 5.</li> </ol>
4	Adjust the placement. <ol style="list-style-type: none"> <li>a. Reset the Printer to clear any Error Messages by removing the power and reapplying it.</li> <li>b. Open the Printer Control Panel from the Computer.               <ul style="list-style-type: none"> <li>• If using Windows 2000/XP, right click on the DTC400e/C30e/M30e Card Printer and select <b>Printing Preferences</b>.</li> </ul> </li> <li>c. Click on the Calibrate tab.</li> <li>d. Click on the <b>Settings</b> button.</li> <li>e. Adjust the Image Placement Setting by +5.</li> <li>f. Click on the <b>OK</b> button.</li> <li>g. Print a self-test.</li> <li>h. After adjusting the Image Placement, if a white border appears on the card, adjust the image placement back toward its original value in</li> </ol>

	<p>increments of 2 until the white edge is gone.</p> <p>i. If still having blank card issues, continue to Step 5.</p>
5	<p>Check the Printhead connections.</p> <p>a. Remove the Printer power and USB cables.</p> <p>b. Turn the Printer over to gain access to the base plate.</p> <p>c. Remove the one (1) screw from the Printhead cover plate and remove the cover plate.</p> <p>d. Depress the Printhead locking tabs and remove the Printhead.</p> <p>e. Check to ensure that Power and Data Cable (that connects to the Printhead) is properly seated.</p> <p>f. Remove the Back Cover.</p> <p>g. Ensure that the Printhead Power/Data Cable is properly seated on J16 on the Main board.</p> <p>h. If still having blank card issues, continue to Step 6.</p>
6	<p>Ensure that the proper voltage is being applied to the Printhead.</p> <p>a. Remove the back cover.</p> <p>b. Using a Digital Voltmeter, connect the negative lead to ground.</p> <p>c. Probe Pins 1 to 5 of the Printhead power connection on J16.</p> <p>d. Ensure that a voltage between 22 to 23 VDC is read on each pin.</p> <ul style="list-style-type: none"> <li>• If less than 22 volts is read on any of the pins, replace the Printhead.</li> <li>• If still having issue with blank cards, replace the Main Board. (<b>Note:</b> Contact an authorized repair center)</li> </ul>

## Resolving the Remove Ribbon Message (Rewriteable Job)

All Troubleshooting procedures assume that only factory-authorized supplies are in use in the Printer.

Step	Procedure
1	<p>Review the following information.</p> <ul style="list-style-type: none"><li>• <b>Symptom:</b> An error message will be displayed when a rewriteable job is submitted to the Printer and there is a Ribbon in the Printer.</li><li>• <b>Printer Error State:</b> The error message will instruct the user to remove the ribbon from the printer.</li><li>• <b>Driver Monitor Error Display:</b> Remove Ribbon</li></ul>

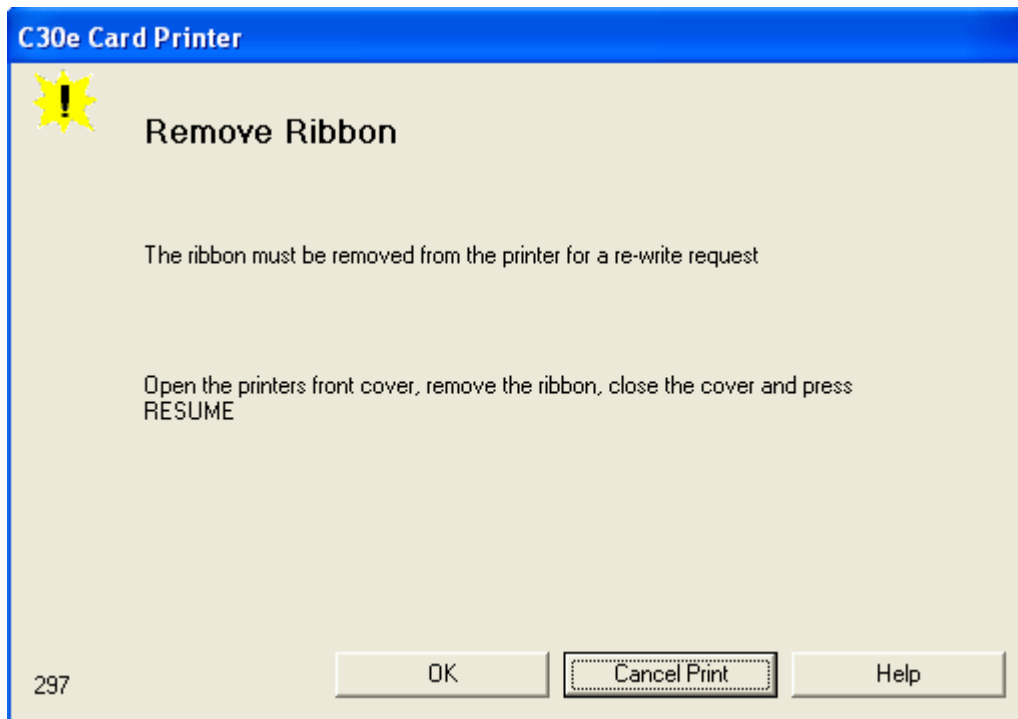

# Flipper Table Module Assembly Problems

## Resolving the No Flipper Table Module problem

All Troubleshooting procedures assume that only factory-authorized supplies are in use in the Printer.

Step	Procedure
1	<p>Review the following information.</p> <ul style="list-style-type: none"> <li>• <b>Symptom:</b> The Flipper Table Module Assembly is not functioning.</li> <li>• <b>Printer Error State:</b> The Printer is unable to communicate with the Flipper Module.</li> <li>• <b>Driver Monitor Error Display:</b> No Flipper Module</li> </ul>

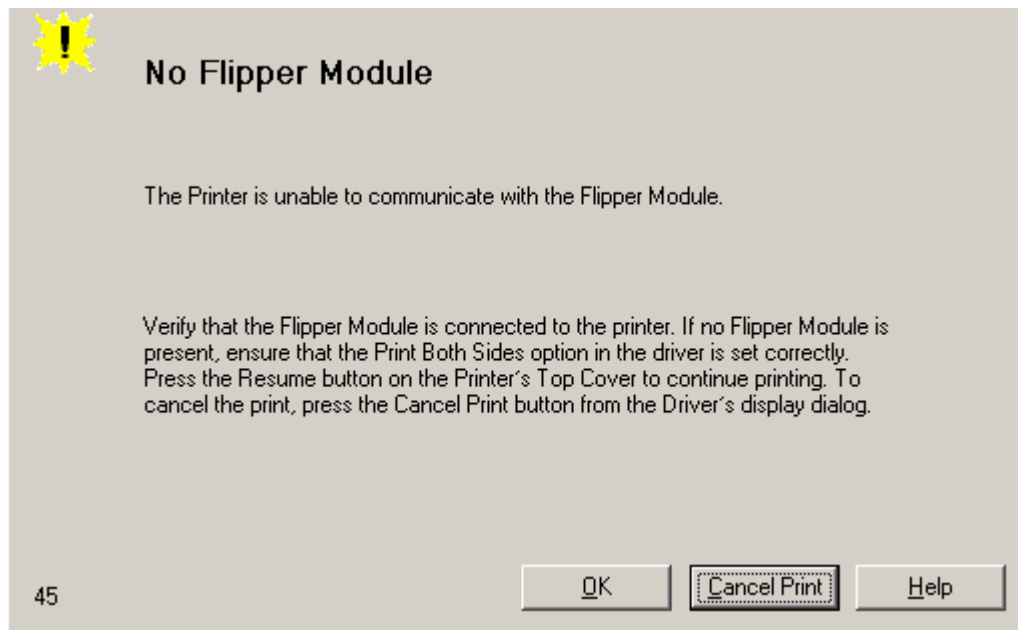

## Resolving the Flipper Jam Error

All Troubleshooting procedures assume that only factory-authorized supplies are in use in the Printer.

Step	Procedure
1	<p>Review the following information.</p> <ul style="list-style-type: none"> <li>• <b>Symptom:</b> The Flipper Table Module is jamming.</li> <li>• <b>Printer Error State:</b> The Flipper Table has jammed while either aligning itself or flipping a card.</li> <li>• <b>Driver Monitor Error Display:</b> Flipper Jam</li> </ul>

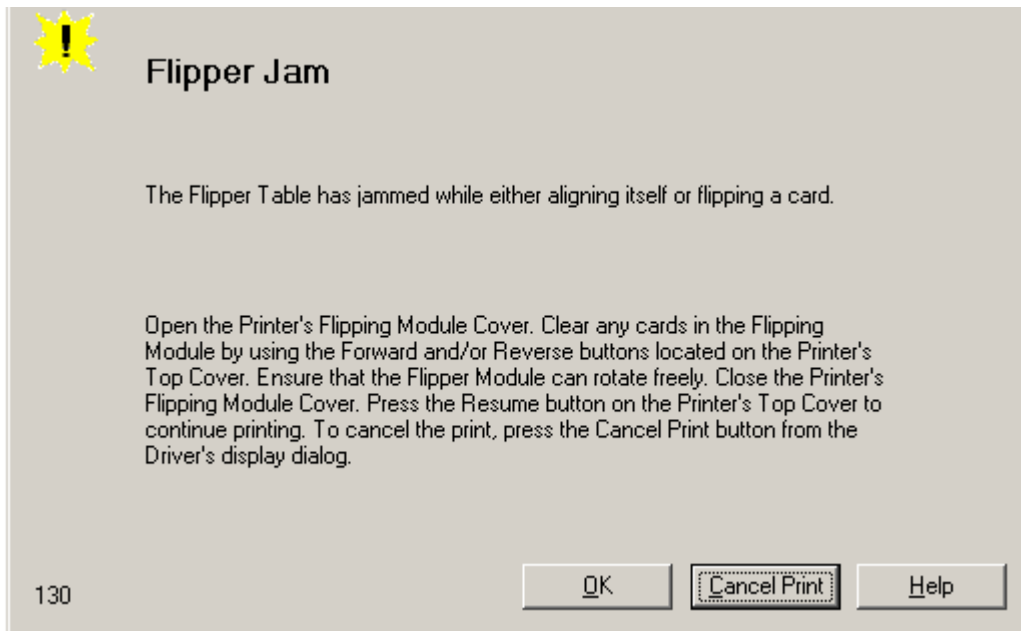

2	<p>Open the Printer's Flipper Table Module Cover.</p> <ol style="list-style-type: none"> <li>a. Clear any cards in the Flipper Table Module by using the <b>Forward</b> and/or <b>Reverse</b> buttons located on the Printer's Top Cover.</li> <li>b. Ensure that the Flipper Table Module can rotate freely.</li> <li>c. Close the Printer's Flipper Table Module.</li> <li>d. Press the <b>Resume</b> button on the Printer's Top Cover to continue printing.</li> <li>e. To cancel the printing, press the <b>Cancel Print</b> button from the Driver's display dialog.</li> </ol>
---	---





## Flipper Jam

The Flipper Table has jammed while either aligning itself or flipping a card.

Open the Printer's Flipping Module Cover. Clear any cards in the Flipping Module by using the Forward and/or Reverse buttons located on the Printer's Top Cover. Ensure that the Flipper Module can rotate freely. Close the Printer's Flipping Module Cover. Press the Resume button on the Printer's Top Cover to continue printing. To cancel the print, press the Cancel Print button from the Driver's display dialog.

130

OK

Cancel Print

Help

## Diagnosing Image Problems

### Resolving the Pixel Failure problems

All Troubleshooting procedures assume that only factory-authorized supplies are in use in the Printer.

Step	Procedure
1	Review the following information. <ul style="list-style-type: none"> <li>• <b>Symptom:</b> A thin line or scratch travels the entire length of the card (See sample image below).</li> <li>• <b>Printer Error State:</b> None</li> <li>• <b>Driver Monitor Error Display:</b> None</li> </ul>
2	Check the card stock for scratches. Replace the cards (as needed).
3	Examine the Printhead for visible damage.
4	Clean the Printhead. See the procedure Cleaning the Printhead
5	Replace the Printhead if the problem persists.



## Resolving the Card Surface Debris problems

All Troubleshooting procedures assume that only factory-authorized supplies are in use in the Printer.

Step	Procedure
1	<p>Review the following information.</p> <ul style="list-style-type: none"> <li>• <b>Symptom:</b> Prints have spots (white or colored voids) and/or dust on them (See sample image below).</li> <li>• <b>Printer Error State:</b> None</li> <li>• <b>Driver Monitor Error Display:</b> None</li> </ul>
2	Ensure the cards are clean and stored in a dust-free environment. Do not use cards with embedded contaminants in the surface.
3	Clean the inside of the Printer. See Cleaning the Printer's Interior
4	Clean the Cleaning Roller. See Cleaning the Platen and the Card Feed Rollers.



## Resolving the Incorrect Image Darkness problems

All Troubleshooting procedures assume that only factory-authorized supplies are in use in the Printer.

Step	Procedure
1	Review the following information. <ul style="list-style-type: none"> <li>• <b>Symptom:</b> Printed cards are too dark or too light.</li> <li>• <b>Printer Error State:</b> None</li> <li>• <b>Driver Monitor Error Display:</b> None</li> </ul>
2	Run a self-test to ensure that the issue is not with the Driver settings.
3	Adjust the <b>Dye-Sub Intensity</b> setting within the Image Color tab of the Printer Driver. See Using the Image Color tab (C30e/M30e) procedure.

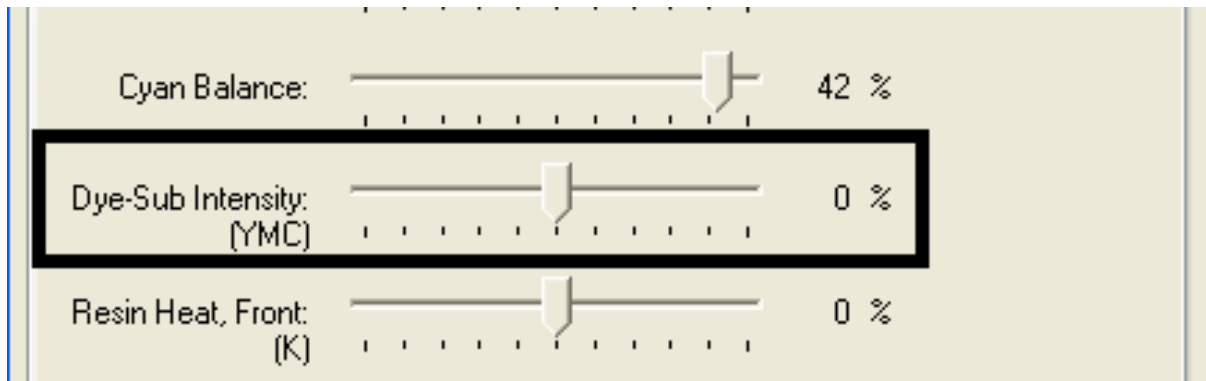

4	Correct the <b>Image Darkness</b> . See the Using the Image Darkness Option procedure.
---	--



## Resolving Ribbon Wrinkle problems

All Troubleshooting procedures assume that only factory-authorized supplies are in use in the Printer.

Step	Procedure
1	Review the following information. <ul style="list-style-type: none"> <li>• <b>Symptom:</b> Printed cards have off-colored lines or streaks on them.</li> <li>• <b>Printer Error State:</b> None</li> <li>• <b>Driver Monitor Error Display:</b> None</li> </ul>
2	Confirm that the Printer is using the most current Driver via: <a href="http://www.fargo.com">http://www.fargo.com</a>
3	Reduce the <b>Dye-Sub Intensity</b> setting within the Image Color tab of the Printer Driver. See the Using the Image Color tab (C30e/M30e).

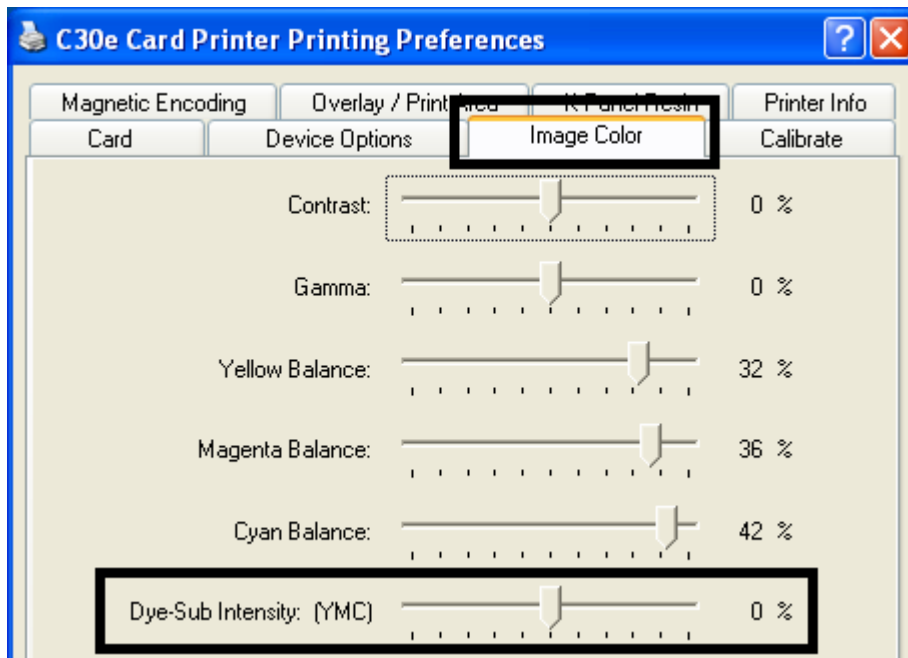

4	Reduce the Image Darkness. See the Using the Image Darkness Option procedure.
---	---

**academics**

**Mike Berman**  
Senior  
**3957105**  
Library Code  
**2439-554**

**HARDING**  
A C A D E M Y

Printed on a FARGO Card Printer. [www.fargo.com](http://www.fargo.com)

## Resolving the Excessive Resin printing problems

All Troubleshooting procedures assume that only factory-authorized supplies are in use in the Printer.

Step	Procedure
1	Review the following information. <ul style="list-style-type: none"> <li>• <b>Symptom:</b> Black resin text and barcodes appear smeared or too thick.</li> <li>• <b>Printer Error State:</b> None</li> <li>• <b>Driver Monitor Error Display:</b> None</li> </ul>
2	Reduce the Resin Heat setting within the Image Color tab of the Printer Driver. See the Using the Image Color tab (C30e/M30e).

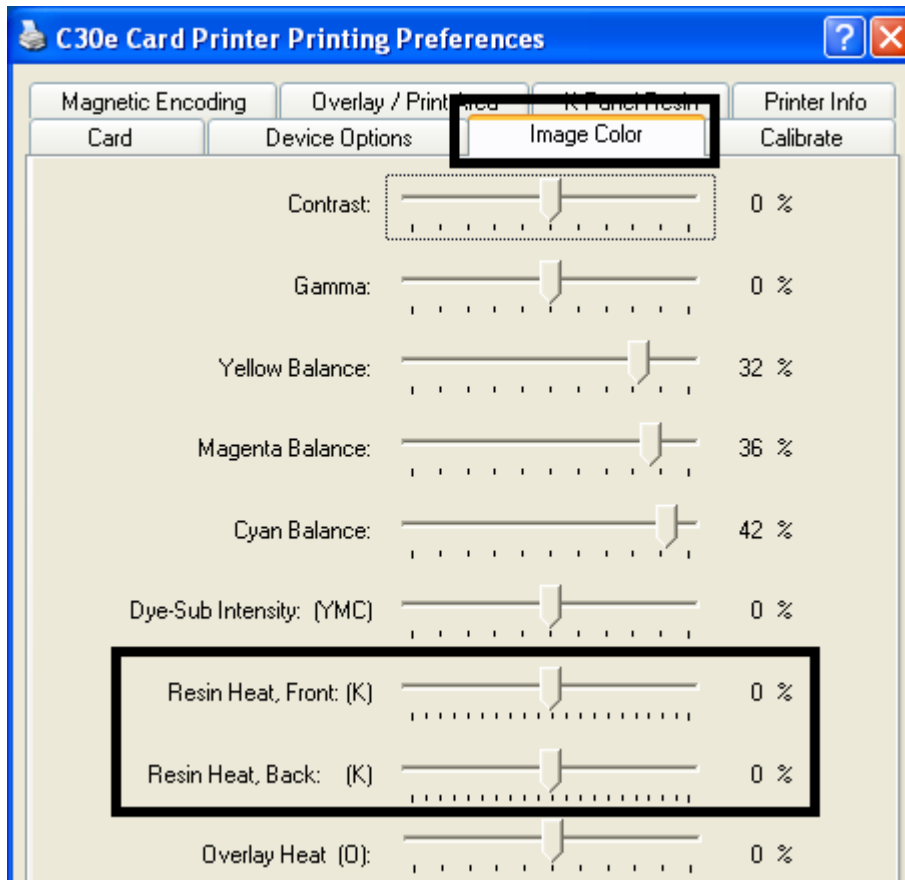

3	Reduce the Image Darkness.
---	----------------------------



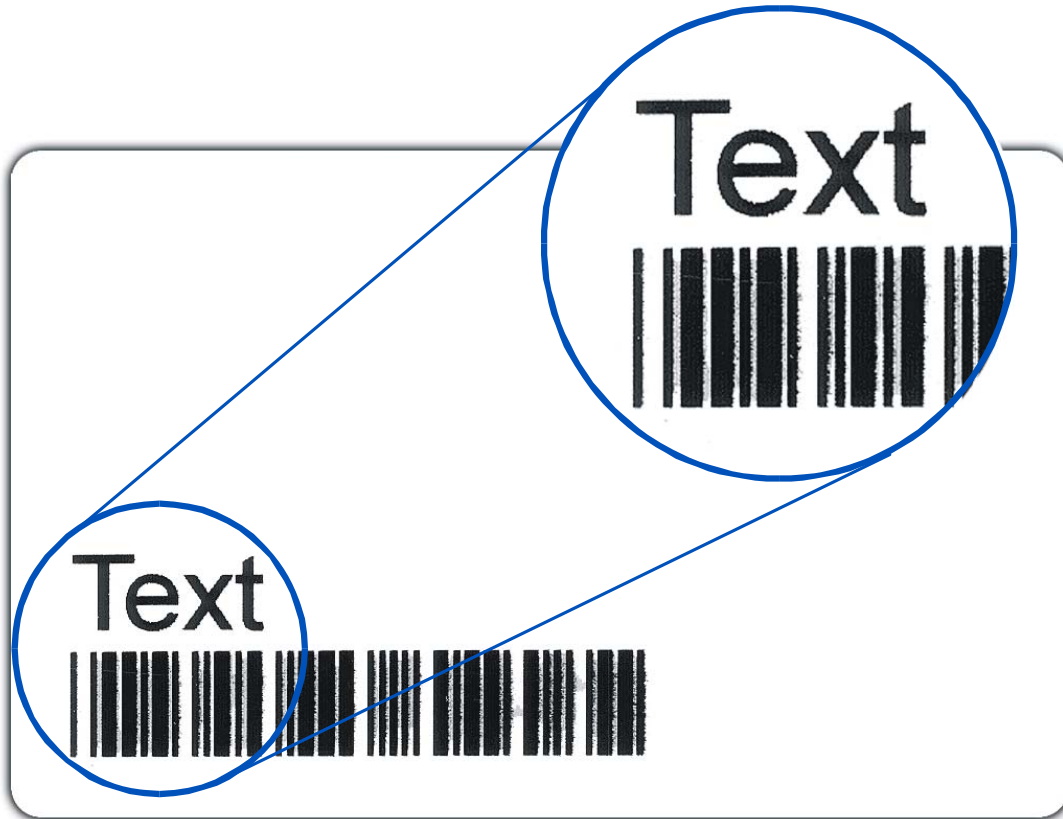

## Resolving the Incomplete Resin printing problems

All Troubleshooting procedures assume that only factory-authorized supplies are in use in the Printer.

Step	Procedure
1	Review the following information. <ul style="list-style-type: none"> <li>• <b>Symptom:</b> Black resin text and barcodes appear faded or too light.</li> <li>• <b>Printer Error State:</b> None</li> <li>• <b>Driver Monitor Error Display:</b> None</li> </ul>
2	Increase the <b>Resin Heat</b> setting within the Image Color tab of the Printer Driver.
3	Increase the <b>Image Darkness</b> . See the Using the Image Darkness Option procedure.

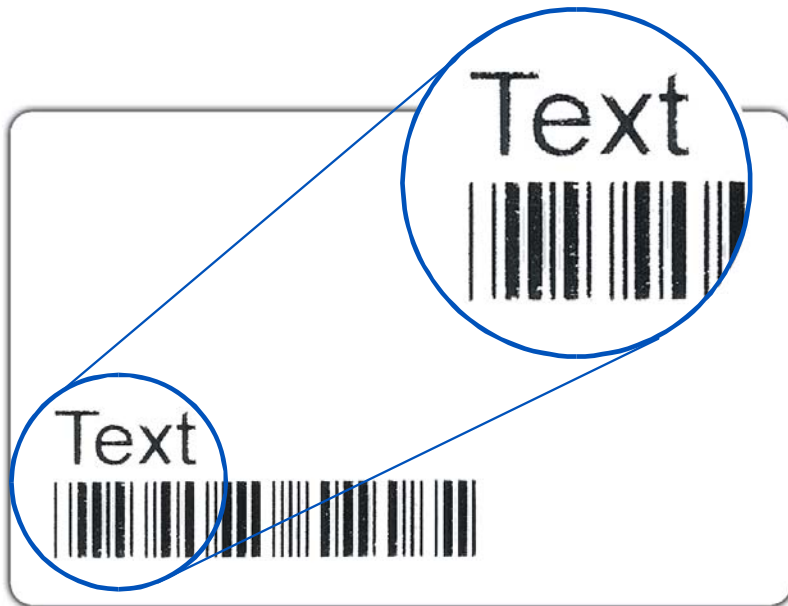

## Resolving the Image Placement problems

All Troubleshooting procedures assume that only factory-authorized supplies are in use in the Printer. This procedure is used to adjust the position of the card in the Print driver and does not change the internal settings of the Printer. See Using the Printer Calibration Utility (Persona C30e/M30e) for instructions on changing the Printer's internal settings.

Step	Procedure
1	Review the following information. <ul style="list-style-type: none"> <li>• <b>Symptom:</b> Printing is cut off or is not centered on the card or a white border appears.</li> <li>• <b>Printer Error State:</b> None</li> <li>• <b>Driver Monitor Error Display:</b> None</li> </ul>
2	Verify if the Image Position option within the Calibrate tab is set correctly or incorrectly. <ol style="list-style-type: none"> <li>a. Open the Printer Control Panel from the Computer.               <ul style="list-style-type: none"> <li>• Right click on the DTC400e/C30e/M30e Card Printer and select <b>Printing Preferences</b>.</li> </ul> </li> <li>b. Click on the Calibrate tab.</li> <li>c. Adjust the <b>Vertical</b> and/or <b>Horizontal Image Position</b> settings based on where the white border is on the card.</li> </ol>

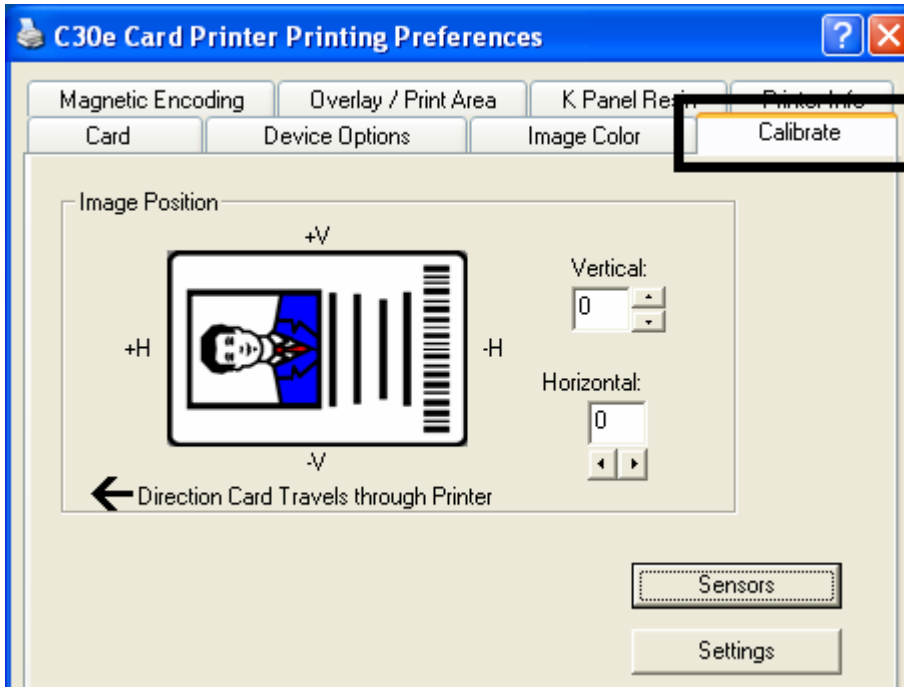

- 3 Verify if the **Horizontal Image Position Setting** is set correctly or incorrectly. See the graphic below.
- If the white border is on the leading edge of the card, adjust the Horizontal value by +2.
  - If the white border is on the trailing edge of the card, adjust the Horizontal value by -2.
- a. Click on **OK**.
  - b. Run a self-test.
  - c. If the white border is diminished, continue the adjustment until it is gone.



4	<p>Verify if the <b>Vertical Image Position Setting</b> is set correctly or incorrectly. See the graphic below.</p> <p>a. Adjust the value as described below:</p> <ul style="list-style-type: none"><li>• If the white border is on the top edge of the card, adjust the Vertical value by +2.</li><li>• If the white border is on the bottom edge of the card, adjust the Vertical value by -2.</li></ul> <p>b. Click on <b>OK</b>.</p> <p>c. Run a self-test.</p> <p>d. If the white border is diminished, continue the adjustment until it is gone.</p>
---	---



## Resolving the Poor Image Quality problems

All Troubleshooting procedures assume that only factory-authorized supplies are in use in the Printer.

Step	Procedure
1	Review the following information. <ul style="list-style-type: none"> <li>• <b>Symptom:</b> Photos on the cards look pixilated or grainy, as shown below.</li> <li>• <b>Printer Error State:</b> None</li> <li>• <b>Driver Monitor Error Display:</b> None</li> </ul>
2	Use high-resolution, 24-bit color images to always capture an image: <ul style="list-style-type: none"> <li>• at a 24-bit color setting</li> <li>• at 300 dpi</li> <li>• at the same size that it will be printed on the card, as captured either with a scanner or with a digital camera</li> </ul> If a small or low-resolution image is stretched or blown up, a pixilated or grainy effect will occur when printing, as shown below (rightside).



**Good**



**Bad**

## Running the Self Test

Perform a self-test after (a) an initial setup of the Printer, (b) a calibration procedure has been conducted or (c) a part has been replaced to check for proper Printer operation.

Step	Procedure
1	Verify that a full-color or Premium Resin Ribbon Cartridge is installed and that cards are properly loaded.   <b>Caution:</b> If the power is ON, disconnect the Power Cable from the Printer's rear panel.
2	Press and hold the <b>Pause/Resume</b> button.
3	While holding down the <b>Pause/Resume</b> button, plug the power cable back into the Printer.
4	<ul style="list-style-type: none"> <li>• <b>Full Color Ribbon Cartridge installed:</b> The Printer will print a 3-color process gray scale on the front of the card. The overlay pass is not printed during the Self-test. (See Display A &amp; B below)</li> <li>• <b>Premium Resin Ribbon Cartridge installed:</b> The Printer will print a single color gray scale on the front of the card.</li> </ul>



## Running the Standard Self Test Print

**Display A:** Full Color Test Print DTC400e & C30e

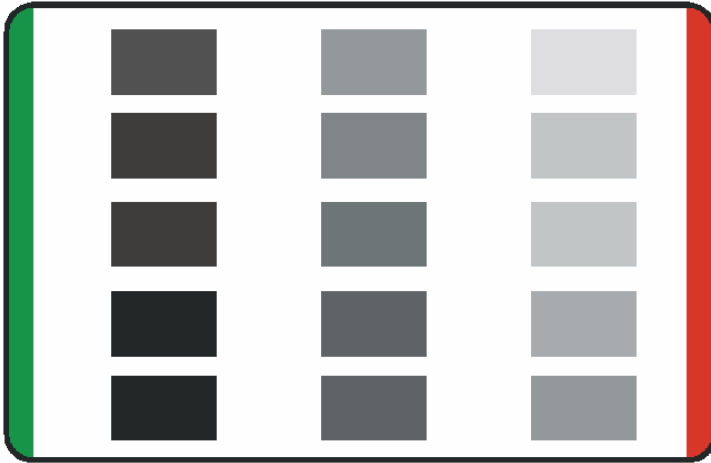

**Display B:** Test Print M30e

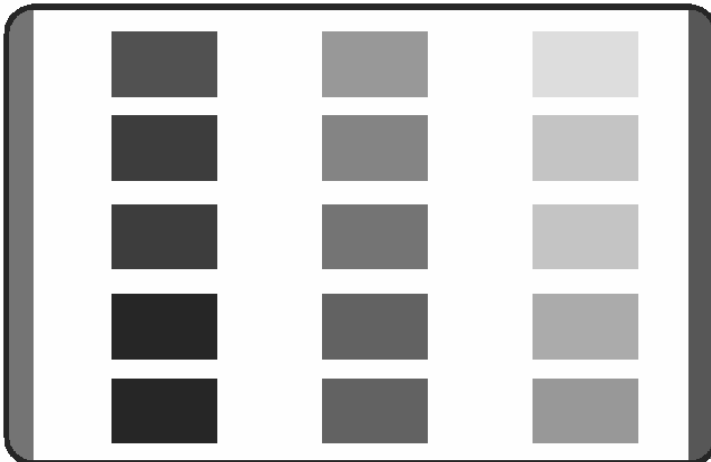

## Running the Magnetic Self Test (HiCo Only)

Perform a self-test after (a) an initial setup of the Printer, (b) a calibration procedure has been conducted or (c) a part has been replaced to check for proper Printer operation.

Step	Procedure
1	Remove Ribbon Cartridge from the Printer and close the front cover  <b>Caution:</b> If the power is ON, disconnect the Power Cable from the Printer's rear panel.
2	Press and hold the <b>Pause/Resume</b> button.
3	While holding down the <b>Pause/Resume</b> button, plug the power cable back into the Printer.
4	The Printer will Encode magnetic information on all 3 magnetic tracks.

# Section 5: Ethernet Option

## Introduction

### DTC400e Persona C30e

The Ethernet option includes the Ethernet port and the internal Printer Server.

- **Printer Management:** The Printer Driver provides bi-directional status information so you can monitor and manage the Printer just as you would any other networked Printer.
- **Compatibility:** The Ethernet option provides compatibility with TCP/IP and 802.3 Ethernet protocols with an IEEE 802.3 10/100Base-T Ethernet female RJ45 connector.
- **Application:** With the Ethernet Option properly installed and configured, these printers are able to print in the same manner as a printer directly connected to the PC via a USB interface.

## Technical Specification - Ethernet Option

Here are the system requirements for Ethernet.



**Caution:** For safety purposes, Ethernet is not intended for a direct connection outside of the building.

Function	Requirement
Network	An IEEE 802.3 10/100 Base-T Ethernet network is required.
Printer	A Printer with the Ethernet option installed is required.
Printer Configuration	Since TCP/IP is used for the network communication, the Printer must be configured with an IP address and a subnet mask (before it can be seen on the network).  An additional network setting for the Default Gateway can also be configured, which allows communication across the subnets.
Host Computer	A PC running Windows 2000 / XP / Server 2003 connected to the network is required.
Host Printer Driver	The host PC must have installed the correct Printer Driver with Ethernet support. ( <b>Note:</b> This Driver must be configured for printing to the IP address of the Printer.)

## Functional Specification - Ethernet Option

The Ethernet option includes these features.

Feature	Description
Simultaneous Printing	Provides the ability to simultaneously print from multiple PCs to the network printer.
Printer Feedback	Provides status information from the network Printer to the PC.
Web Pages	Provides easy Printer configuration with any web browser.
Log Messages	Provides logging of usage and error events via e-mail, UDP or TCP/IP.
Password Security	Provides security with passwords and configurable User permission levels.
Telnet	Provides a Telnet command line interpreter for Printer configuration.
SNMP	Provides an SNMP agent that supports MIB-II.
Upgrades	Provides support for Firmware upgrades over the network.
Troubleshooting	Provides a Ping client for network troubleshooting.
IP Tracer	Provides a utility (IP Tracer) used to find Printers with Ethernet connection on a local network. ( <b>Note:</b> This utility is included on the CD-ROM )

## Network Services - Overview

The Ethernet option provides the services described in this section. (**Note:** Other additional services include a Ping client, address assignment and Printer discovery functions.)

### Reviewing the Print Server

The Print Server provides printing services in the same manner as a printer connected directly to a USB interface except that the Printer is connected through the local area network to the client PC. The Print Server must be properly configured in order to provide this printing capability.

- The Print Server is capable of queuing up to eight (8) client PCs while printing. Communications between each PC and the Ethernet-enabled Printer are implemented over a bi-directional TCP/IP interface.
- All clients are able to send print jobs to the Printer and monitor Printer jobs and errors with the standard Windows printing system using the Printer Driver installed on their local PC.

In this way, the User knows whether or not a print job has been successful. Also, the User knows what problems have been encountered while processing the print job. Printing using Ethernet works in a manner similar to the USB-connected PC/printer.

### Reviewing the Web Page Server

An HTTP service serves web pages that provide an interface through which to configure and monitor the Printer. (**Note:** Users may also monitor all print jobs that have been sent to the Printer from any client PC.)

### Reviewing the Network Management Interface

The Ethernet-enabled Printer operates as an SNMP agent to allow central administrators to monitor and configure the network interface and the Printer. (**Note:** A standard host MIB-II is implemented to maximize the utility of the Printer on the network.)

### Reviewing the Telnet Server

The Ethernet interface has a command line interpreter. (**Note:** The User can connect to the Printer using a Telnet session on their PC, issue commands to the Printer and receive response from the Printer.)

The Telnet commands are primarily used for network administration, and they will not be used by most Users. (**Note:** These commands will query the state of the Printer and configure various settings for the Printer. These include network settings, logging setting, User names and User passwords.)

## Network Management Interface

The SNMP interface is described below.

Interface	Description
SNMP	<ul style="list-style-type: none"> <li>The Ethernet interface is a fully-manageable SNMP agent that supports MIB-II.</li> <li>The Ethernet interface is MIB II compliant, allowing SNMP managers to monitor protocol, network and routing statistics.</li> </ul>

## Telnet Command Line Interface

### Initiating a Telnet Session

This procedure shows how to initiate a Telnet session from a PC in order to access the Telnet services provided by the Printer. Follow these instructions to issue Telnet commands. See the next section for related **Ethernet Printer Troubleshooting** procedures.

Step	Description
1	Identify the IP address of your Printer.
2	<p>Initiate a Telnet session from a DOS window on your PC. At the DOS prompt, enter telnet [IP Address]</p> <p><b>Example:</b> C:\&gt;telnet 192.168.11.12</p> <ul style="list-style-type: none"> <li>All Telnet responses from the Printer will then be displayed in the Telnet session on the PC.</li> <li>All commands entered will be sent to the Telnet client in the Printer.</li> </ul>
3	Enter help or ? to get an on-window list of supported Telnet commands.

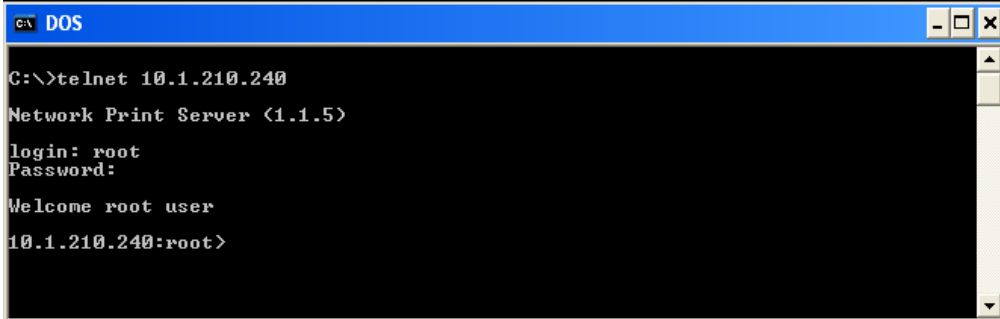

```

C:\>telnet 10.1.210.240
Network Print Server <1.1.5>
login: root
Password:
Welcome root user
10.1.210.240:root>
  
```

## Reviewing the Telnet Command Table

The following table describes available Telnet commands. (**Note:** You can enter partial full-word commands: the Printer will respond with additional help. For example, you can enter list, and the Printer will respond with all subcommands to the list command.)

Telnet Command		Command Purpose	Command Format	
?		Display help for Telnet commands.	?	
help				
reset		Reset the Ethernet interface for the Printer/Encoder.	reset	
ping		Send a ping command to another IP address as a test of the Ethernet interface.	ping <IPADDR>	
list	all	Display all information about this Printer.	list all	
	diff	Display all differences between current and stored network settings.	list diff	
	uptime	Display how long since the interface was last reset.	list uptime	
	sysinfo	Display information about the Printer (i.e., model, label, contact, location, Firmware version and date, and serial number).	list sysinfo	
	ribbon	Display information about the installed Ribbon in the Printer.	list ribbon	
	net	Display information about the current network settings of the Ethernet interface.	list net	
	stored	net	Display information about the stored network settings of the Ethernet interface.	list stored net
	default	net	Display information about the default network settings of the Ethernet interface.	list default net

Telnet Command		Command Purpose	Command Format	
	user	Display information about the defined User names and their type (root or guest privileges).	list user	
	lpq	Display information about print jobs and their settings.	list lpq	
	printer	Display information about the Printer (i.e., model number, Firmware version and serial number).	list printer	
	printer	sm	Display information about the secure mark settings of the Printer.	list printer sm
set	sysinfo	contact	Set the contact string.	set sysinfo label [<STRING>]
		location	Set the location string.	set sysinfo location [<STRING>]
		label	Set the label string.	set sysinfo label [<STRING>]
		from	Set all strings from default or current settings.	set sysinfo from default current
	syslog	name	Change the name of a system log path	set syslog <LOG_NAME> name <NEW_NAME>
		type	Change the type of a system log path. This starts or stops logging on start of jobs or on faults.	set syslog <LOG_NAME> type [[-]job] [[-]pfault]
		dest	Change the destination of a system log path. This may be set to none, e-mail, udp or tcp.	set syslog <LOG_NAME> dest none email udp tcp
		email	Change the e-mail address for e-mail notification for a system log path. It must specify a valid e-mail address.	set syslog <LOG_NAME> email <EMAIL>
		udp	Specify the IP address of the UDP system logging program.	set syslog <LOG_NAME> udp <IPADDRESS>



Telnet Command		Command Purpose		Command Format
set		from	Restore system log path settings from the default or current settings.	set syslog from default current
	user	add	Add a new User definition. Up to four (4) Users may be defined.	set user add <NAME>
		del	Delete a User definition.	set user del <NAME>
		passwd	Define a new password for a User.	set user passwd <NAME> [<PASSWORD>]
		type	Specify a User as root or guest. Only root Users have administrative rights to change network interface settings.	set user type <NAME> root guest
		from	Restore User setting from default or stored settings.	set user from default stored
store	net	addr	Store a new IP address.	store net addr <ADDRESS>
		mask	Store a new address mask.	store net mask <MASK>
		gateway	Store a new default gateway.	store net gateway <ADDRESS>
		dns	Store a new DNS server address.	store net dns <ADDRESS>
		domain	Store a new DNS domain suffix.	store net domain <STRING>
		opts	Enable or disable automatic address assignment using DHCP. Static (non-automatic) addresses will come from the stored or default settings, depending on the other settings.	To enable automatic address assignment: store net opts dhcp  To disable automatic address assignment: store net opts -dhcp

Telnet Command		Command Purpose		Command Format
		from	Restore the network settings from either the default settings or the current settings.	store net from default current
	ifc	mode	Specify the Ethernet interface mode as: automatic, full or half duplex; 10 or 100 mHz.	store ifc mode auto 10half 10full 100half 100full
		from	Set the Ethernet mode settings from the default or current settings.	store ifc from default current
save			Save all current settings as the stored settings in the permanent memory.	save
load			Take the settings from the stored memory and make them the current settings.	load
lpstat			Display information about the Printer status.  This includes the status and device response.  See the Printer web page description.	lpstat
cancel			Cancel a specific print job from the print queue.	cancel 10
quit			Stop the current Telnet session.	quit

# Ethernet Printer Troubleshooting Procedures

If you are having trouble connecting to your Ethernet Printer or printing to it, you should go through each of the following procedures.

Step	Procedure
1	Follow the Verifying the Printer Connection procedure. See below.
2	Follow the Verifying the Printer IP address procedure.
3	Follow the Verifying that your PC can access the Printer using the ping command procedure.
4	Verify that you are choosing the correct Printer Driver. ( <b>Note:</b> The Driver must match the model of the Printer.)
5	Verify that the port configuration of the PC Printer Driver is set to communicate to the Printer over the correct IP address. See Reviewing Frequently-asked Questions.
6	Follow the Printing a test page procedure.

## Verifying the Printer Connection

Step	Procedure
1	Ensure that your Printer has a valid network connection.
3	Verify that the Printer has both LEDs blinking on and off with network activity.
3	If the LEDs do not indicate connection, verify the network connection with another device.
4	If the connection is OK, then something may be wrong with the Ethernet option installation. See the Ethernet Setup and Printer Driver Installation procedure.

## Verifying the Printer IP address

Step	Procedure
1	<p>Check for a valid IP address (0.0.0.0 is not valid).</p> <ul style="list-style-type: none"> <li>If the IP address is valid, go to step 4 (below).</li> <li>If the IP address is not valid, go to step 2 (below).</li> </ul>
2	<p>If your network is using DHCP, then:</p> <ul style="list-style-type: none"> <li>Use IP-Tracer to verify that the Printer has not been configured to use a static address.</li> </ul> <p><b>(Note:</b> This guideline applies unless you have a known, unused static IP address assigned to this Printer.)</p>
3	<p>If you are using a static IP address, then:</p> <ul style="list-style-type: none"> <li>Verify that there is no other device using the same address by removing your Printer and ping to the desired address.</li> </ul> <p>If any device responds, then you must find a different available IP address.</p>
4	<p>If the Printer reports an IP address, then:</p> <ul style="list-style-type: none"> <li>Verify that it matches subnet of the network where it is connected.</li> </ul> <p>If your Printer has DHCP disabled, then:</p> <ul style="list-style-type: none"> <li>The static IP address may have been previously set for a different subnet.</li> </ul>

## Verify that the PC can access the Printer using the ping command

Step	Procedure
1	<p>Follow these instructions to issue a ping command to the Printer:</p> <p>At a DOS prompt, enter <b>ping [IP Address]</b></p> <p><b>Example:</b> C:\&gt;ping 210.1.10.240</p> <ul style="list-style-type: none"> <li>• If the ping response is successful, move on to the next troubleshooting procedure. See Display A below.</li> <li>• If the ping response is not successful, continue to step 2 of this procedure. See Display B below.</li> </ul>

### Display A - Example of sending a ping to the Printer with a successful response

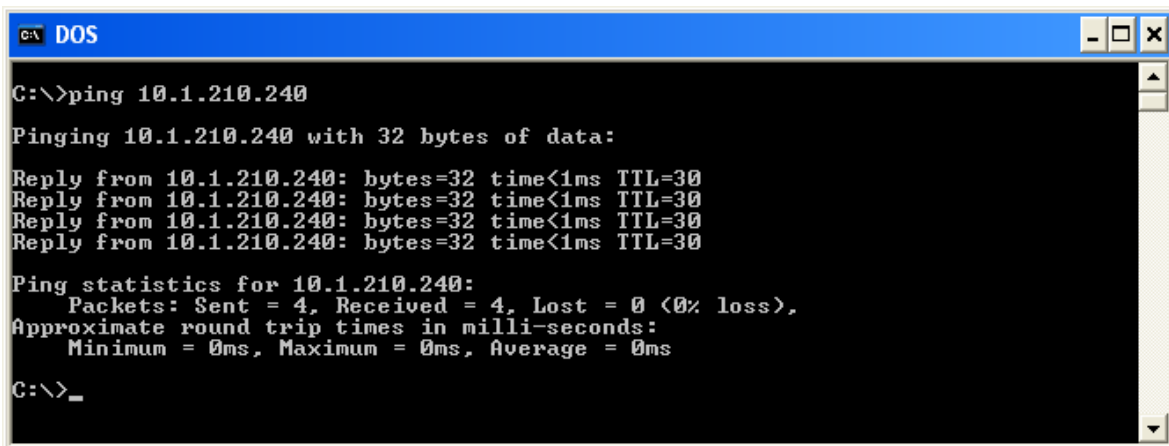

```

C:\>ping 10.1.210.240

Pinging 10.1.210.240 with 32 bytes of data:

Reply from 10.1.210.240: bytes=32 time<1ms TTL=30
Reply from 10.1.210.240: bytes=32 time<1ms TTL=30
Reply from 10.1.210.240: bytes=32 time<1ms TTL=30
Reply from 10.1.210.240: bytes=32 time<1ms TTL=30

Ping statistics for 10.1.210.240:
    Packets: Sent = 4, Received = 4, Lost = 0 (0% loss),
    Approximate round trip times in milli-seconds:
        Minimum = 0ms, Maximum = 0ms, Average = 0ms

C:\>_
    
```

### Display B - Example of ping timeout to an invalid IP address

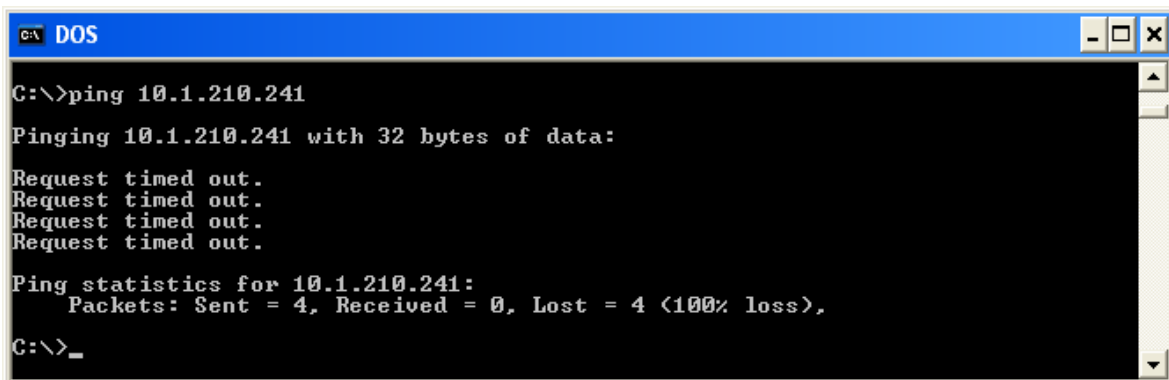

```

C:\>ping 10.1.210.241

Pinging 10.1.210.241 with 32 bytes of data:

Request timed out.
Request timed out.
Request timed out.
Request timed out.

Ping statistics for 10.1.210.241:
    Packets: Sent = 4, Received = 0, Lost = 4 (100% loss),

C:\>_
    
```

2	Verify that the PC and the Printer are connected to the same network.
---	---

3	<p>You may be on different subnets of your network and some of the network settings for the Printer are not correct. See your network administrator about this.</p> <p><b>(Note:</b> The subnet mask must be the same as other devices on the network, and that the unique IP address is part of the network specified by the subnet mask.)</p>
---	---

## Printing a test page

Step	Procedure
1	<p>Try printing a test page from the Printer Driver properties window.</p> <ol style="list-style-type: none"> <li>a. Open the Printer Driver properties window.</li> <li>b. Select Start -&gt; Settings -&gt; Printers and Faxes -&gt; [your Printer Driver name (i.e., DTC400e or C30e Card Printer)] -&gt; Properties.</li> <li>c. Ensure that the printing preferences are set correctly for the Ribbon installed in your Printer.</li> <li>d. Then select the <b>Print Test page</b> button. See the next section.</li> </ol>
2	<p>If you cannot print a test page, then consider the following:</p> <ul style="list-style-type: none"> <li>• There may be an error at the Printer.</li> <li>• There may be a job in the Windows print queue which has stalled.</li> <li>• The Printer may be paused or set to operate offline in the Windows print queue.</li> </ul>

## Reviewing Frequently-asked Questions

Question	Answer
How do I know if my Printer has the Ethernet option installed?	If your Printer has the RJ45 connector installed on the back of the Printer, then it has this Ethernet option installed.
Can my non-Ethernet-enabled Printer be upgraded to have an Ethernet interface?	No.
What PC operating systems work with my Ethernet Printer?	The Windows 2000/ XP/ Server 2003 operating systems work with your Ethernet Printer.
How do I connect my Printer to my network?	<p>You can connect from the RJ45 network connection on the back of your Printer to an available connection on your network (not directly to your PC).</p> <p>You can use a good CAT-5 or better cable to make this connection.</p>
How can I find the MAC address of my Ethernet Printer?	<p>If you know the IP address of your Printer, you can access this through the home web page of the Print Server.</p> <p><b>OR</b></p> <p>If you do not know the IP address or the Printer does not work with a usable IP address, then the MAC Address can be found using the IP Tracer tool.</p>
How can I find the IP address of my Ethernet Printer?	See Verifying the Printer IP address.
Can I print from my PC to multiple Ethernet Printers?	Yes. Use the Windows "Add Printer Wizard" to create a new printer instance for the additional printer. This may require adding a new "Remote TCP/IP Card Printer Port" configured to communicate to the new printer at the proper IP address. See the appropriate Windows documentation for additional help.
Can multiple PC's print to my Ethernet Printer?	Yes. Each PC must have the Printer Driver software installed for the specific Fargo Ethernet-enabled Printer and connect to the intended Printer, using the correct IP address.

Question	Answer
Can I print from my PC to an Ethernet Printer on a different network segment?	Yes. If you know the IP address of the Printer on any segment of your network, you will be able to print to it.
Can I use IP Tracer to locate Printers on a different network segment?	No. The IP Tracer can only locate Printers located in the same network segment (as the PC running IP Tracer).
How do I upgrade the Printer Firmware in my Ethernet-enabled Printer?	<p>This is done in the same manner as a USB connected Printer. The PC doing the upgrade must have a Driver installed for the Fargo Printer to be upgraded.</p> <p>Follow this procedure.</p> <ol style="list-style-type: none"> <li>1. Run the Fargo Workbench Printer Utility from the start menu: Go to the Start -&gt; Programs -&gt; Fargo -&gt; Fargo Workbench Printer Utility -&gt; Fargo Workbench.</li> <li>2. Select the Fargo Printer to upgrade from the drop-down box.</li> <li>3. Go to the Firmware Updates tab.</li> <li>4. If you need to download the update file from the Internet, select the <b>Download Firmware</b> button.</li> <li>5. Choose the update file with the <b>Select Firmware</b> button.</li> <li>6. Put your Printer into the upgrade mode. See the instructions for your specific Fargo Printer.</li> <li>7. Select the <b>Send Firmware</b> button.</li> </ol>
What is the default User name and password for the Printer?	<p>The default passwords are blank (i.e., an empty string).</p> <ul style="list-style-type: none"> <li>• The default Users are as follows: <b>root</b> as the administrative User and <b>guest</b> as a non-administrative User.</li> <li>• The Printer supports four (4) Users.</li> </ul>
What if I lose the password for my Printer or it is not accepted?	<p>Factory default settings will be restored to the Printer if power is applied to the Printer with Dipswitch 1 in the <b>ON</b> position and Dipswitch 2 in the <b>OFF</b> position.</p> <p>(<b>Note:</b> This will reset all Print Server settings, which includes static network settings, user configurations and user passwords.)</p>



Question	Answer
<p>What should I do if the IP address of my Printer is being changed by my network?</p>	<p>Follow this procedure:</p> <ol style="list-style-type: none"> <li>1. Contact your network administrator. Ask that your current IP address be reserved or ask that they provide a specific IP address that you can use to configure the Ethernet interface.</li> </ol> <p><b>OR</b></p> <ol style="list-style-type: none"> <li>2. Choose an IP address that you know will not be used by any other PC, server or network device. Use those settings to configure your Printer with static network settings.</li> </ol> <p><b>(Caution:</b> Do not do this unless you know that these settings will always be available.)</p>
<p>How do I reconfigure my PC Printer Driver to connect to a different Printer or different IP address?</p>	<p>Use the Windows “Add Printer Wizard” to create a printer instance to communicate to the printer at the new IP address.</p> <p>This may require adding a new “Remote TCP/IP Card Printer Port” configured to communicate to the printer at the proper IP address.</p> <p>See the appropriate Windows documentation for additional help.</p>
<p>How can I verify/change what IP address my installed Printer Driver is expecting to find my Printer?</p>	<p>Follow this procedure.</p> <ol style="list-style-type: none"> <li>1. Open the Printer Driver properties window.</li> <li>2. Select <b>Start -&gt; Settings -&gt; Printers and Faxes -&gt; [your Printer Driver] -&gt; Properties.</b></li> <li>3. From the Ports tab, select <b>Configure Port.</b> The Host name will indicate IP address of the connected Printer. <b>(Note:</b> If this does not match your Printer’s IP address, you can change it from this window.)</li> <li>4. Enter the correct IP address.</li> <li>5. Select <b>OK.</b></li> <li>6. Select <b>Apply.</b></li> <li>7. Select <b>Close.</b></li> </ol>

Question	Answer
How do I configure my Printer's IP settings?	<p>By default, the Printer is configured for dynamic IP address assignment. That is, it will try to get its IP address and other settings from your network. If it is given valid network settings, it will use them.</p> <p><b>OR</b></p> <p>You can choose to configure the Printer, using a static IP address and network settings. (<b>Note:</b> This can be entered using the Network web page of the Printer or the IP Tracer program.)</p>
How do I choose a static IP address for my Ethernet Printer?	<p>You can use the web pages if you know the current IP address.</p> <p><b>OR</b></p> <p>You can use the IP Tracer tool, which allows you to find Printers and specify their addresses.</p> <p>(<b>Note:</b> You can save static addresses. However, they are not used until you reconfigure the Printer to use those static addresses and reboot the Printer.)</p>
How do I set the Printer to work with a static IP address?	<p>You can use the web pages if you know the current IP address.</p> <ul style="list-style-type: none"> <li>• Select the <b>Use the following IP address</b> button on the Network web page.</li> </ul> <p><b>OR</b></p> <ul style="list-style-type: none"> <li>• Use the IP Tracer tool, which allows you to find Printers and specify their addresses.</li> </ul>
What do the LEDs by the Ethernet connection on the back of the Printer indicate?	<p>The LEDs indicates network activity.</p>
How do I print a test page from Windows to verify the Ethernet configuration of the Printer and Printer Driver?	<p>Follow this procedure.</p> <ol style="list-style-type: none"> <li>1. Open the Printer Driver properties window.</li> <li>2. Select Start -&gt; Settings -&gt; Printers and Faxes -&gt; [your Printer Driver name (i.e., DTC400e or C30eCard Printer)] -&gt; Properties.</li> <li>3. Ensure that the printing preferences are set correctly for the Ribbon installed in your Printer. Then select the <b>Print Test page</b> button.</li> </ol>

# Glossary of Terms



<b>Term</b>	<b>Purpose</b>
MAC (Media Access Control)	The unique numeric value address associated with a network device that gives the device a unique identity. This address is assigned by the device manufacturer to ensure its uniqueness.
TCP (Transmission Control Protocol)	The Network protocol that allows reliable network communications between devices.
IP (Internet Protocol)	The Network protocol that identifies devices and messages by addresses so that communications can occur between devices on different local networks.
TCP/IP	Network communications using TCP and IP protocols.
ICMP (Internet Control Message Protocol)	The Basic message protocol for the internet.
DHCP (Dynamic Host Configuration Protocol)	The protocol used by a network to automatically assign network settings to connected devices so that they will work together.
DNS (Domain Name System)	Defines the Network protocol that allows devices to find IP addresses from a network name server.
DNS Server Address	This is the address of the server that provides the translation from a descriptive name to an IP address.
DNS Domain Suffix	This is the suffix to be added to the domain name make a complete name.
SNMP (Simple Network Management Protocol)	This is protocol for the network management services. This protocol provides a means for network compliant devices, called agents, to store data about themselves in Management Information Bases (MIBs) and return this data to the SNMP requesters.

Term	Purpose
MIB (Management Information Base)	A formal description of the way an agent can be accessed using SNMP and the functions that can be managed.
Network Settings	The basic network parameters needed to configure the network interface. ( <b>Note:</b> These include the IP Address, the Subnet Mask, the Default Gateway, the DNS Server Address and the DNS Domain Suffix.)
IP addresses	Specifies the current IP addresses that are 32-bit values that are normally expresses in dotted-quad format. ( <b>Note:</b> This address must not be the same as another device on the same local network.)
Subnet mask	Specifies a 32-bit value that routers use to send a message to the correct subnet.
Default gateway	Specifies the address of the router (in a network using subnets) that forwards traffic to a destination outside of the subnet of the transmitting device.
Telnet	This is a common terminal emulation program that allows a User to send commands to a TCP/IP connected device and receive the responses.
UDP (User Datagram Protocol)	Defines a protocol for sending and receiving messages on a network.
Syslog	The standard method for logging system events.
Root User	A User with administrative rights to change any Printer settings.
Guest User	A User without rights to change Printer settings.
Ping	A common utility or command that sends a message to network devices asking for a return message. ( <b>Note:</b> This is used to diagnose if the device is on the network or to troubleshoot the connection.)

# Section 6: Printer Adjustments

See this section for printer adjustments.

## Safety Messages (review carefully)

Symbol	Critical Instructions for Safety purposes
<p><b>Danger:</b></p> 	<p><b>Failure to follow these installation guidelines can result in death or serious injury.</b></p> <p>Information that raises potential safety issues is indicated by a warning symbol (as shown to the left).</p> <ul style="list-style-type: none"> <li>• <b>To prevent personal injury</b>, refer to the following safety messages before performing an operation preceded by this symbol.</li> <li>• <b>To prevent personal injury</b>, always remove the power cord prior to performing repair procedures, unless otherwise specified.</li> <li>• <b>To prevent personal injury</b>, make sure only qualified personnel perform these procedures.</li> </ul>
<p><b>Caution:</b></p> 	<p><b>This device is electrostatically sensitive. It may be damaged if exposed to static electricity discharges.</b></p> <p>Information that raises potential electrostatic safety issues is indicated by a warning symbol (as shown to the left).</p> <ul style="list-style-type: none"> <li>• <b>To prevent equipment or media damage</b>, refer to the following safety messages before performing an operation preceded by this symbol.</li> <li>• <b>To prevent equipment or media damage</b>, observe all established Electrostatic Discharge (ESD) procedures while handling cables in or near the Circuit Board and Printhead Assemblies.</li> <li>• <b>To prevent equipment or media damage</b>, always wear an appropriate personal grounding device (e.g., a high quality wrist strap grounded to avoid potential damage).</li> <li>• <b>To prevent equipment or media damage</b>, always remove the Ribbon and Cards from the Printer before making any repairs, unless otherwise specified.</li> <li>• <b>To prevent equipment or media damage</b>, take jewelry off of fingers and hands, as well as thoroughly clean hands to remove oil and debris before working on the Printer.</li> </ul>

## DTC400e/C30e/M30e Print Driver Options

The window title reflects the C30e Printer Driver in use as shown in this section.

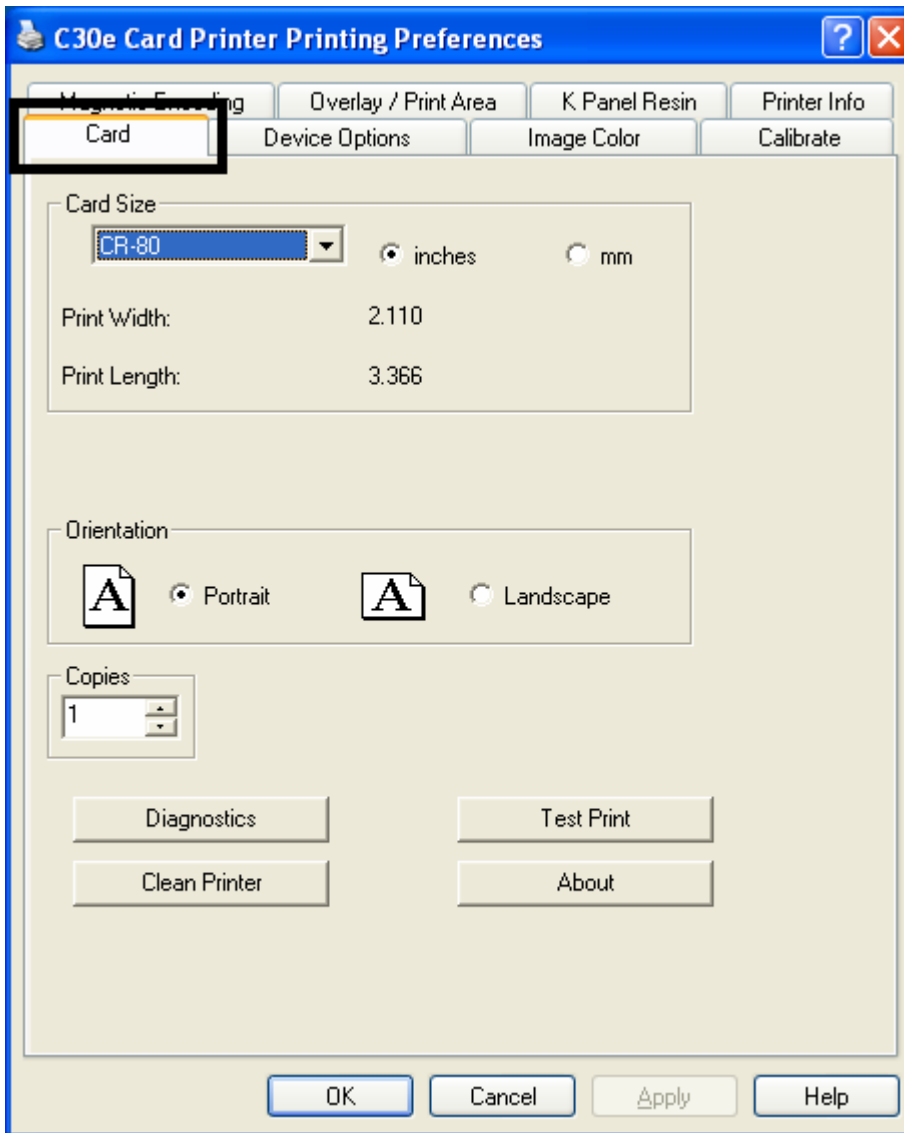

# Using the Card tab (DTC400e/C30e/M30e)

## Adjusting the Card Size Option

Step	Description
1	<p>Click <b>inches</b> or <b>mm</b> to choose the desired unit of measurement.</p> <p><b>(Note No.1:</b> When designing a card format, always set the card size or page size within the card design program to the exact dimensions of a CR-79 or CR-80 card.)</p> <p><b>(Note No.2:</b> The Card Size indicates that the Printer accepts standard, credit card size CR-80 (ISO ID-1) cards or CR-79 sized cards. The dimensions of the total print area for this card size appear in the <b>Print Width:</b> and <b>Print Length:</b> areas, as shown below.)</p>



## Adjusting the Orientation Option

Step	Description
1	Select <b>Portrait</b> to cause the card to print in a vertical orientation. <b>OR</b> Select <b>Landscape</b> to cause the card to print in a horizontal orientation. (Note: An icon illustrating a printed card helps represent the difference between the two.)

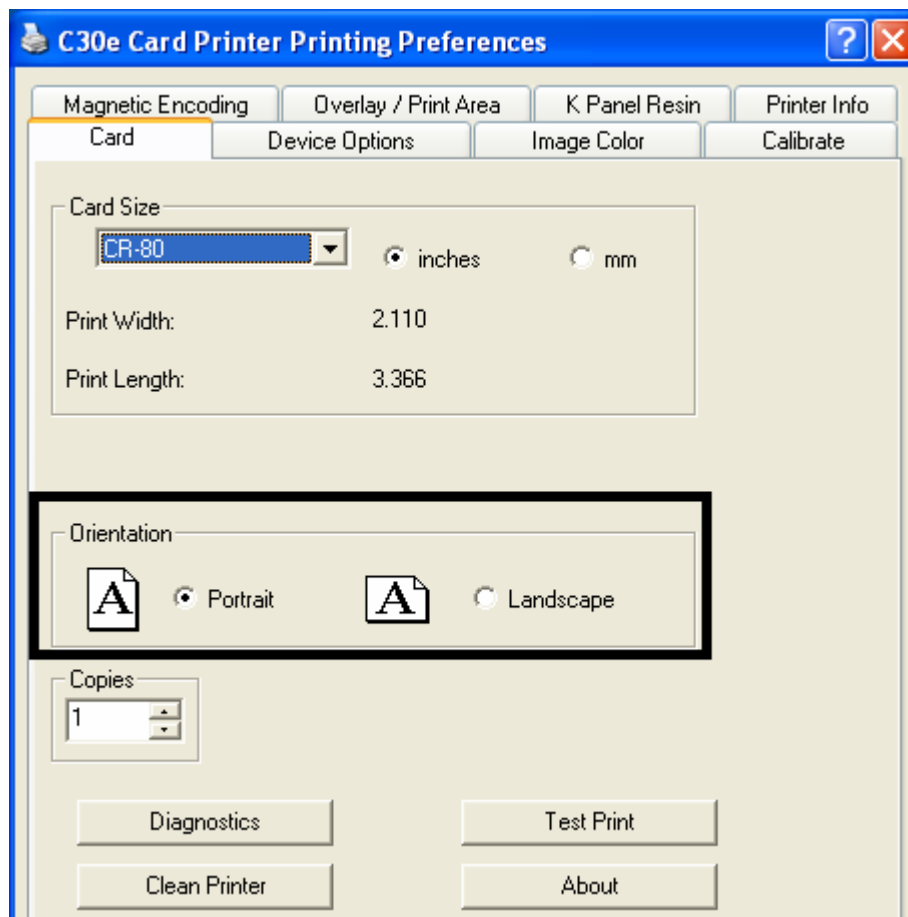



## Selecting the number of copies

Step	Description
1	Select the number of copies by clicking on the UP or DOWN arrows, as shown below.

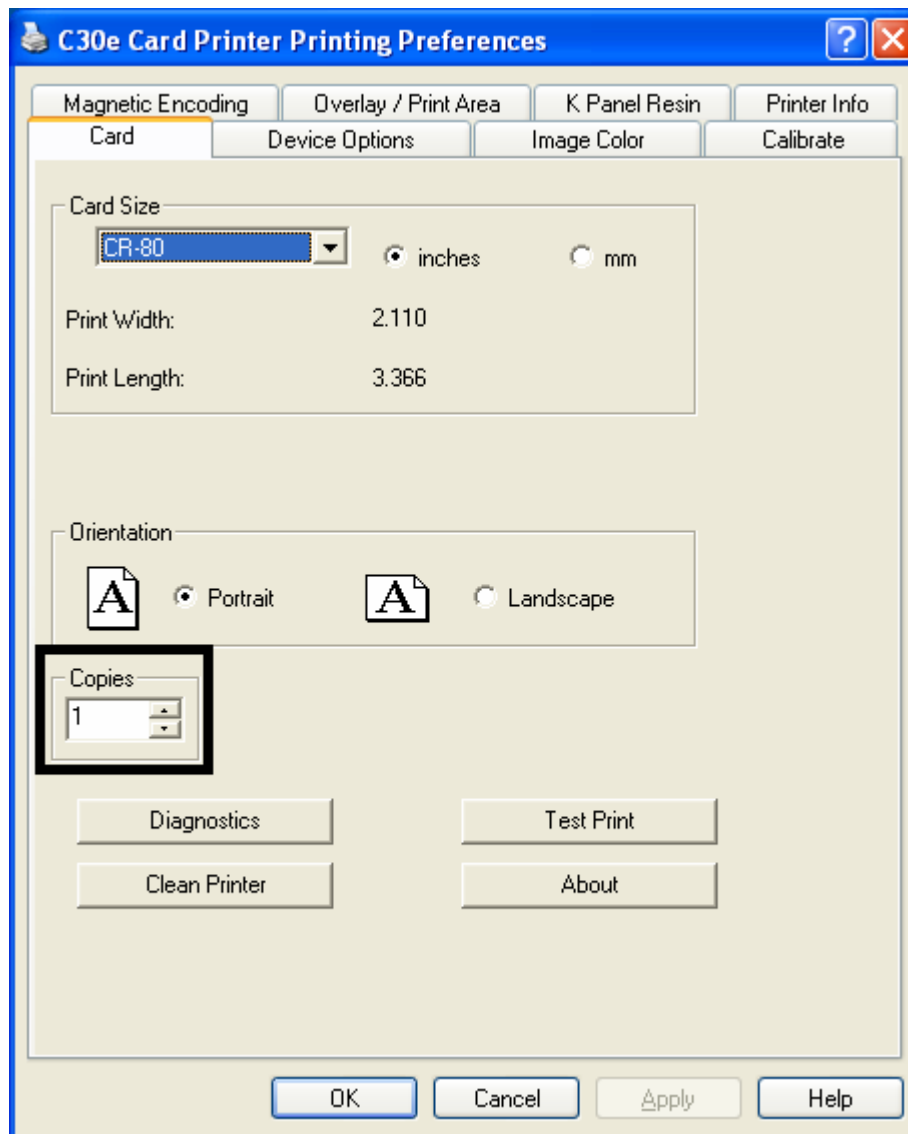

## Using the Diagnostics button under the Card tab

Step	Description
1	Click <b>Diagnostics</b> to bring up the Fargo Workbench Printer Utility window.

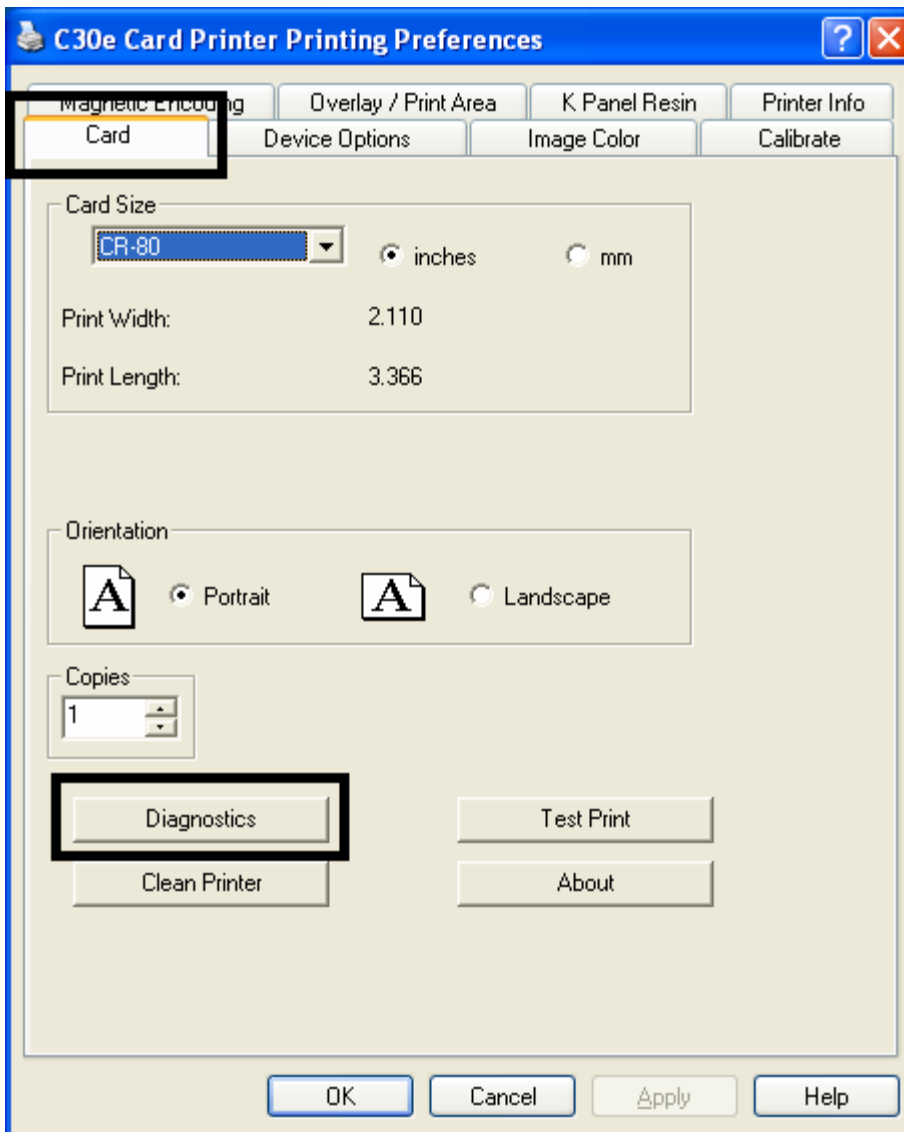

## Using the Clean Printer Option

Step	Description
1	Click <b>Clean Printer</b> to display the Clean Printer Utility window.
2	Remove all cards from the Card Hopper and close the Hopper door.
3	Open the Front Cover and remove the Ribbon Cartridge.
4	Remove the paper backing from both sides of the Cleaning Card.
5	Place the Cleaning card into the Single Feed Slot.

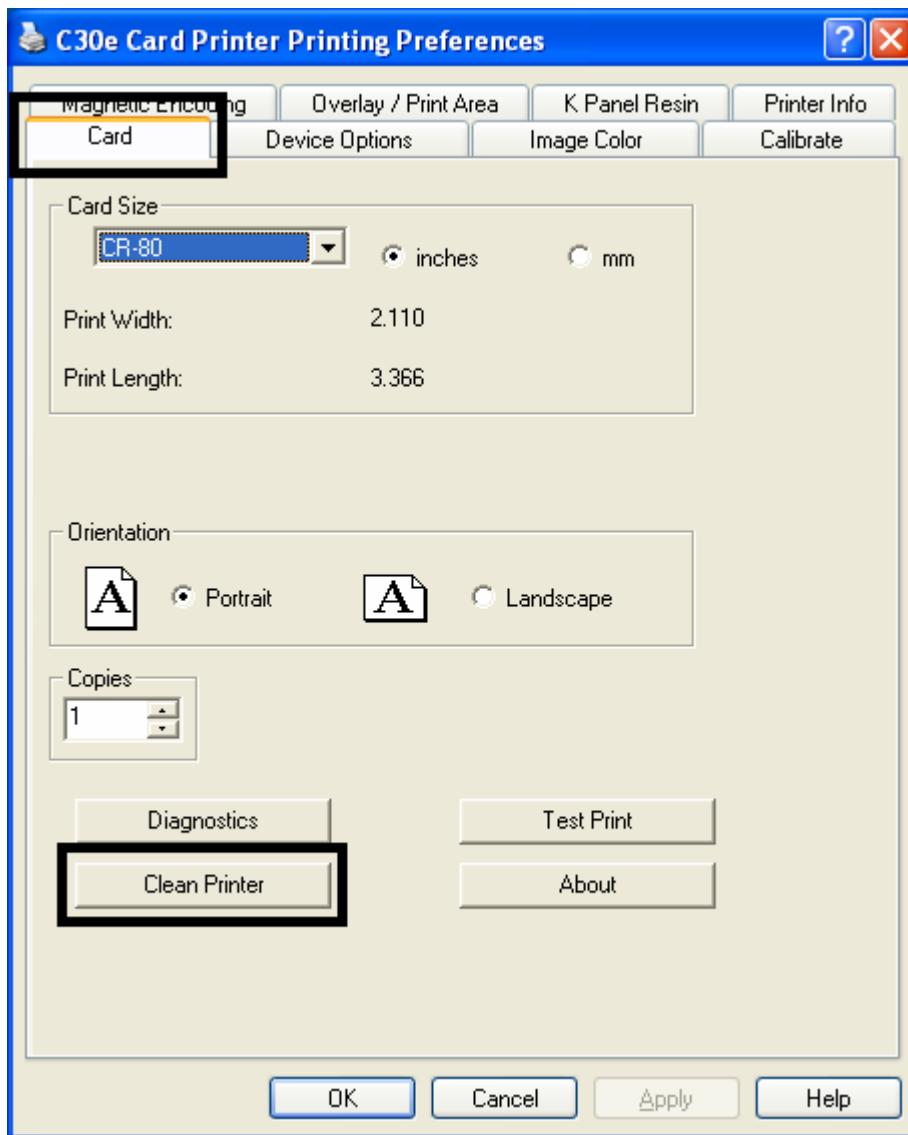

6	Click <b>Clean</b> . ( <b>Note:</b> The Printer will begin to feed the cleaning card through the card path.)
7	Reinsert the print Ribbon and cards after the cleaning procedure has completed.

**C30e Card Printer - Clean Printer Utility**
✕

Instructions:

- Remove all cards from Card Hopper.
- Close the Card Hopper Cover.
- Open the Front Cover and remove the Ribbon Cartridge
- Remove the paper backing from both sides of Cleaning Card.
- Place the Cleaning Card into the Single Feed Slot.
- Close the Front Cover and press the Clean button below.

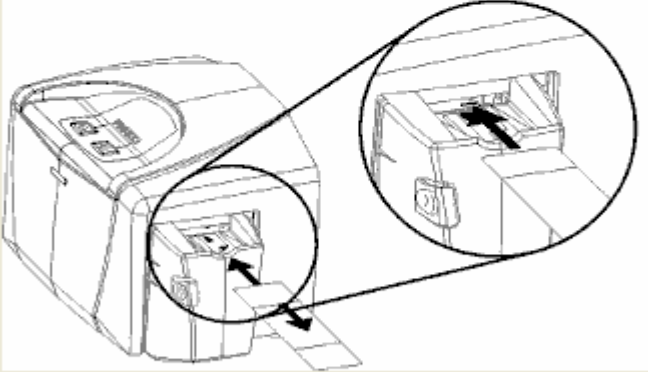

Clean

Enable Reminder

Fargo Cleaning Kit PN : 085976  
Fargo Cleaning Card PN : 085974

Note: The Cleaning routine will begin after all current print jobs have completed.

## Using the Test Print button

Step	Description
1	<p>Click <b>Test Print</b> to send a simple self-test print to the DTC400e or C30e Printer.</p> <ul style="list-style-type: none"> <li>• Ensure that an YMCKO Ribbon is installed.</li> <li>• Ensure that the computer is effectively communicating with the Printer and that the Printer is functioning properly.</li> <li>• Ensure that an <b>YMCKOK</b> Ribbon is installed in order for a DTC400e/C30e Card Printer with a Flipper Table Module to print a dual-sided image.</li> </ul>
2	<p>Click <b>Test Print</b> to send a simple self-test print to the M30e Printer.</p> <ul style="list-style-type: none"> <li>• Ensure that the Ribbon is installed for M30e</li> <li>• Ensure that the computer is effectively communicating with the Printer and that the Printer is functioning properly.</li> </ul> <p>Ensure that the Ribbon is installed in order for a M30e Card Printer with a Flipper Table Module to print a dual-sided image.</p>

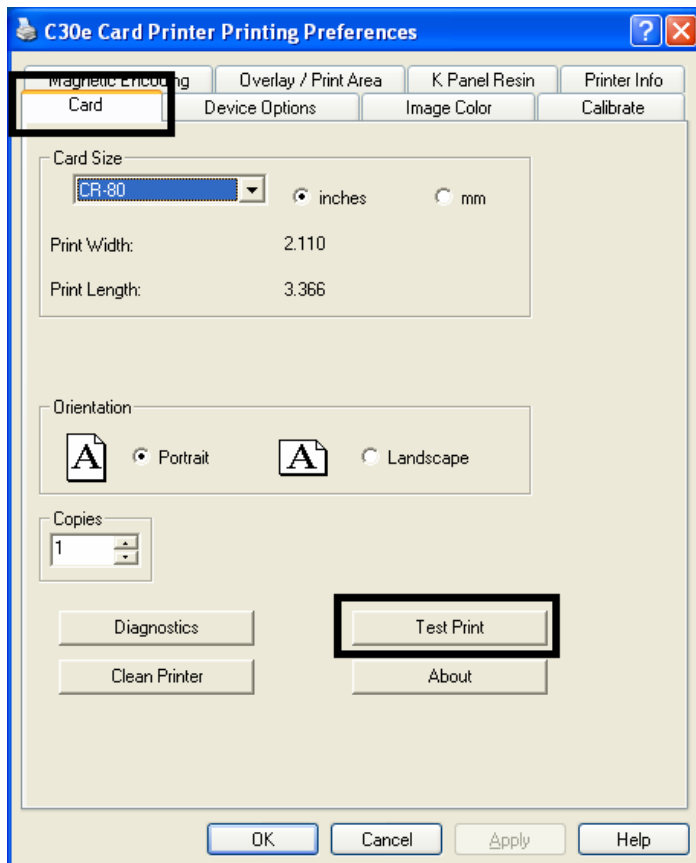

## Using the About button

Step	Description
1	Click <b>About</b> to open a dialog box containing the copyright and version, date code information about this Printer Driver software.

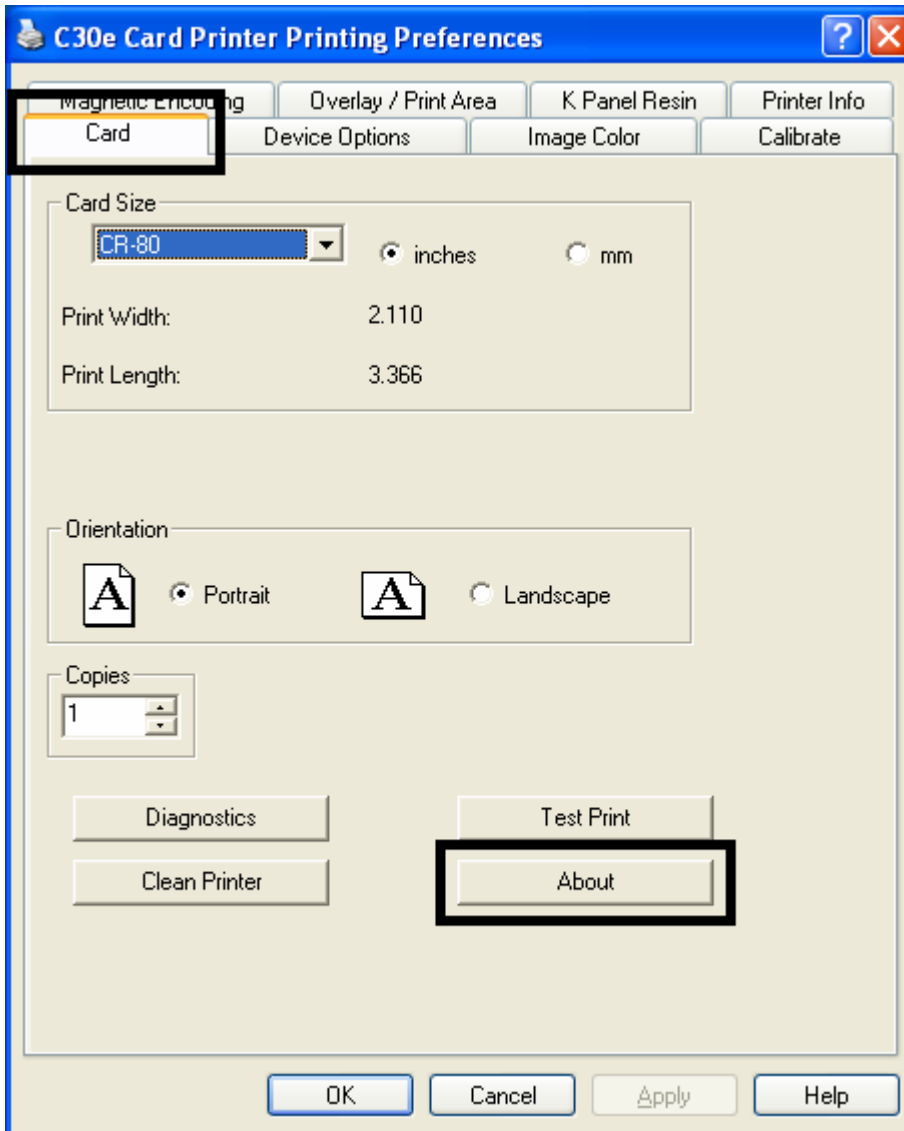

## Using the Device Options tab (DTC400e/C30e or M30e)

The DTC400e/C30e window with the Device Options tab is displayed below.

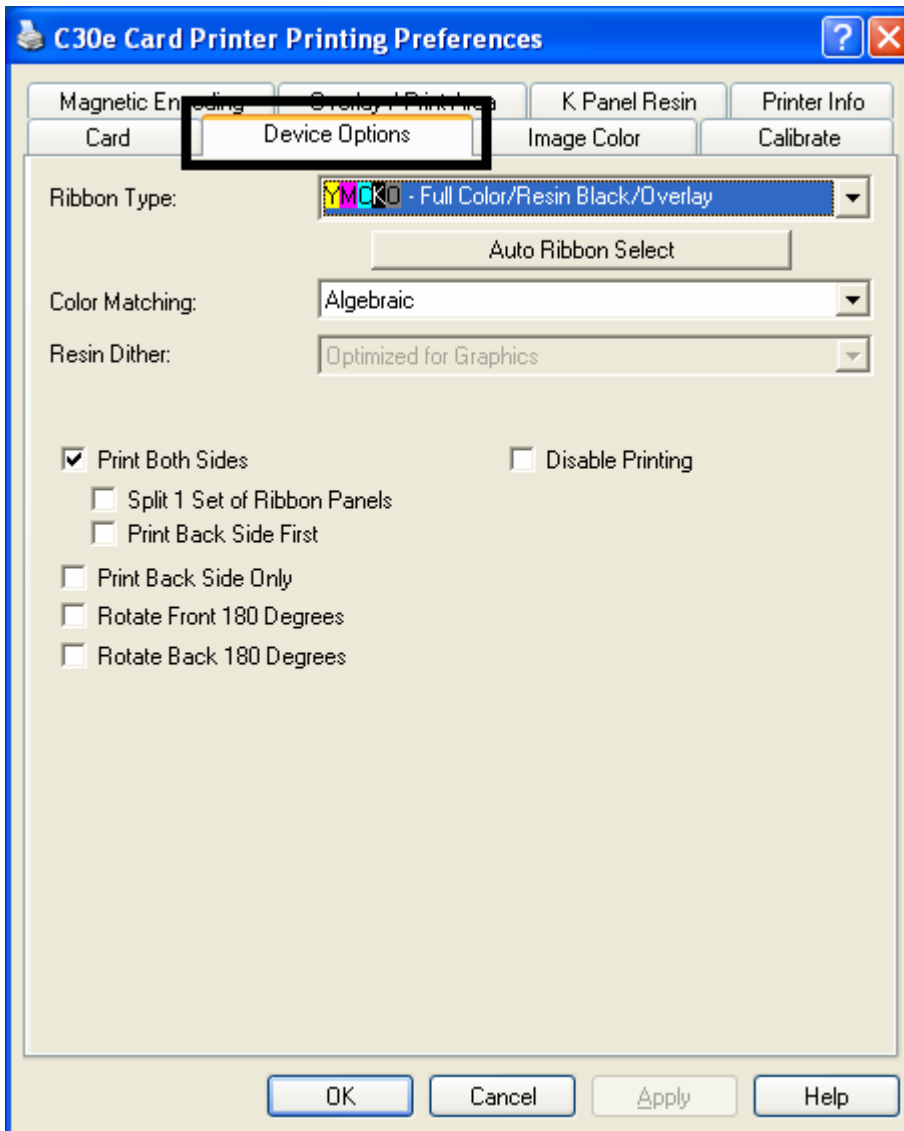

The M30e window with the Device Options tab is displayed below.

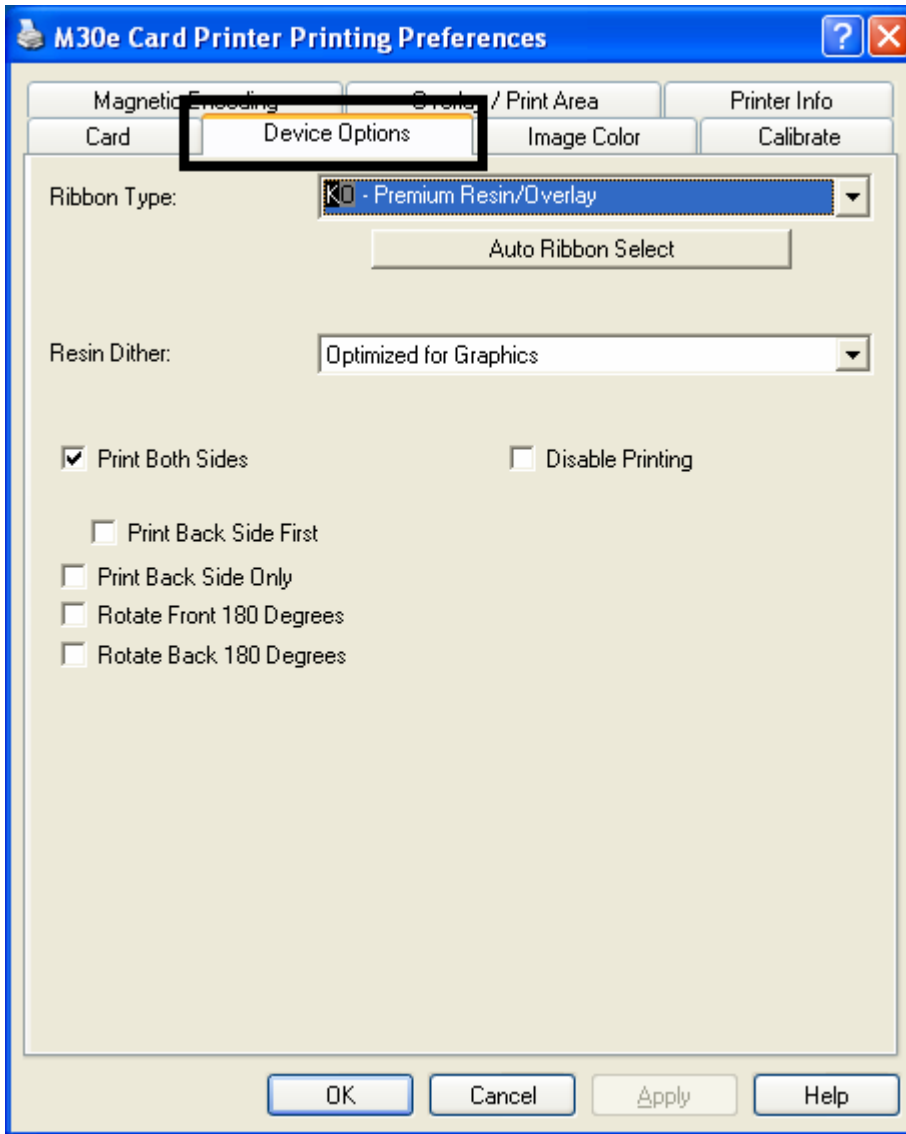



## Adjusting the Ribbon Type option

Use the Ribbon Type option to select Print Ribbons for DTC400e/C30e.

Step	Description
1	<p>Adjust to match the Ribbon <b>Type</b> selection with the Ribbon <b>Type</b> already loaded in the Printer.</p> <ul style="list-style-type: none"> <li>• <b>YMCKO:</b> Yellow, Magenta, Cyan, Resin Black, Overlay <b>OR</b></li> <li>• <b>YMCKO:</b> Yellow, Magenta, Cyan, Resin Black, Overlay/Half Panel <b>OR</b></li> <li>• <b>YMCKOK:</b> Yellow, Magenta, Cyan, Resin Black, Overlay, Resin Black <b>OR</b></li> <li>• <b>KO Resin:</b> Black, Overlay <b>OR</b></li> <li>• <b>K:</b> Standard or Premium Resin <b>OR</b></li> <li>• <b>Colored Resin:</b> Colored Resin is available in Red, Blue, Green or White <b>OR</b></li> <li>• <b>Metallic Resin:</b> Metallic Resin is available in Gold or Silver <b>OR</b></li> <li>• <b>YMCFKO:</b> Yellow, Magenta, Cyan, Fluorescing, Resin Black, Overlay <b>(DTC400e only)</b> <b>OR</b></li> <li>• <b>YMCFKOK:</b> Yellow, Magenta, Cyan, Fluorescing, Resin Black, Overlay, Resin Black <b>(DTC400e only)</b> <b>OR</b></li> <li>• <b>NONE-</b> Re-Writable</li> </ul>

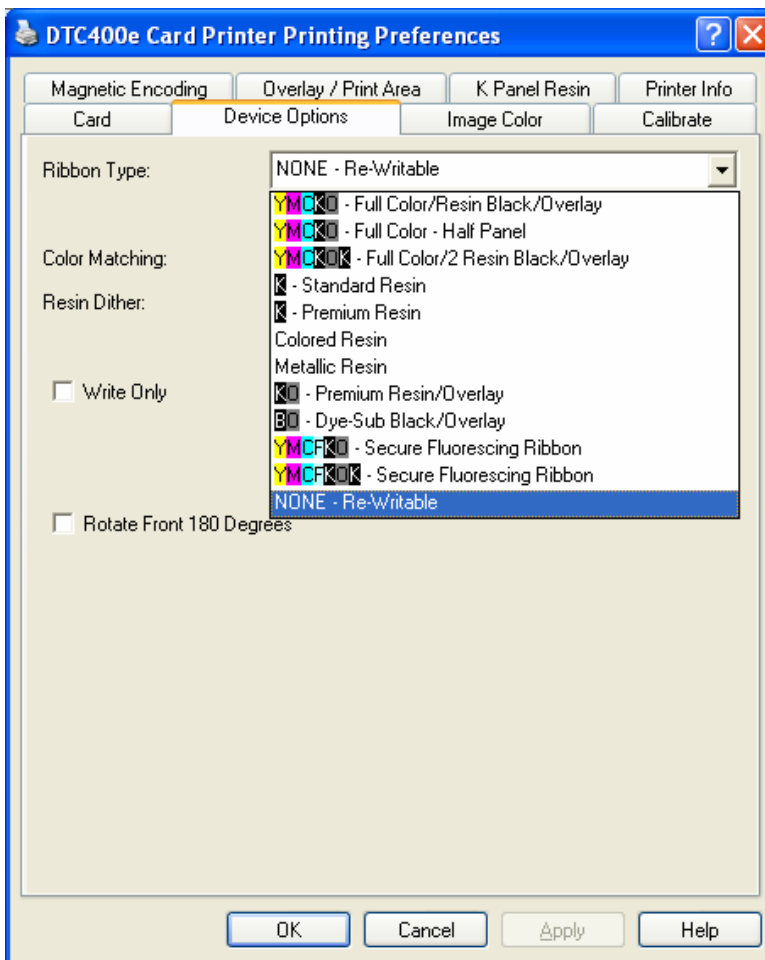
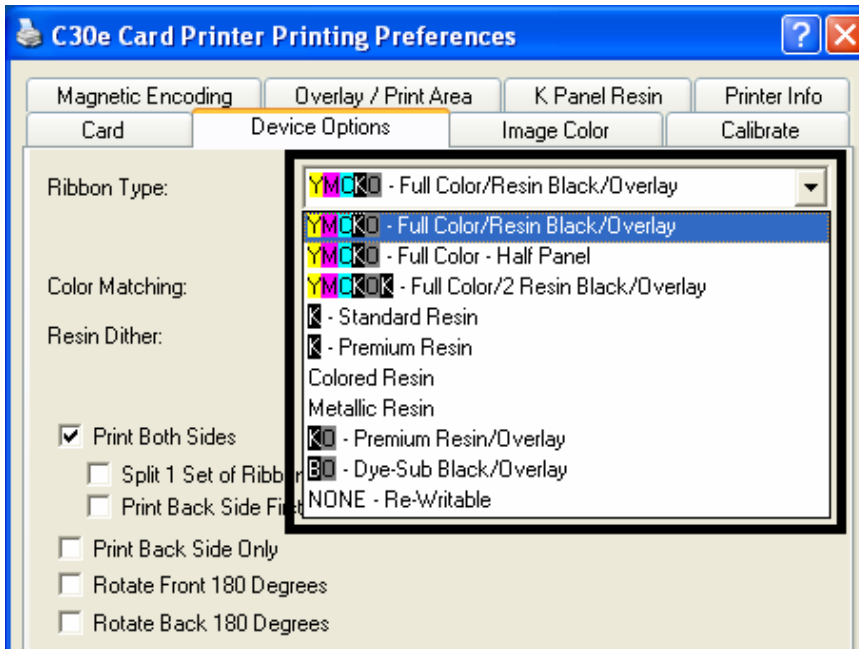

Use the Ribbon Type option to select Print Ribbons for the M30e.

Step	Description
1	Select the appropriate <b>Ribbon</b> for the type of Print Ribbon in use. <ul style="list-style-type: none"> <li>• K – Standard Resin</li> <li>• K – Premium Resin</li> <li>• Colored Resin</li> <li>• Metallic Resin</li> <li>• KO – Premium Resin/Overlay</li> <li>• BO – Dye-sub Black/Overlay</li> </ul>

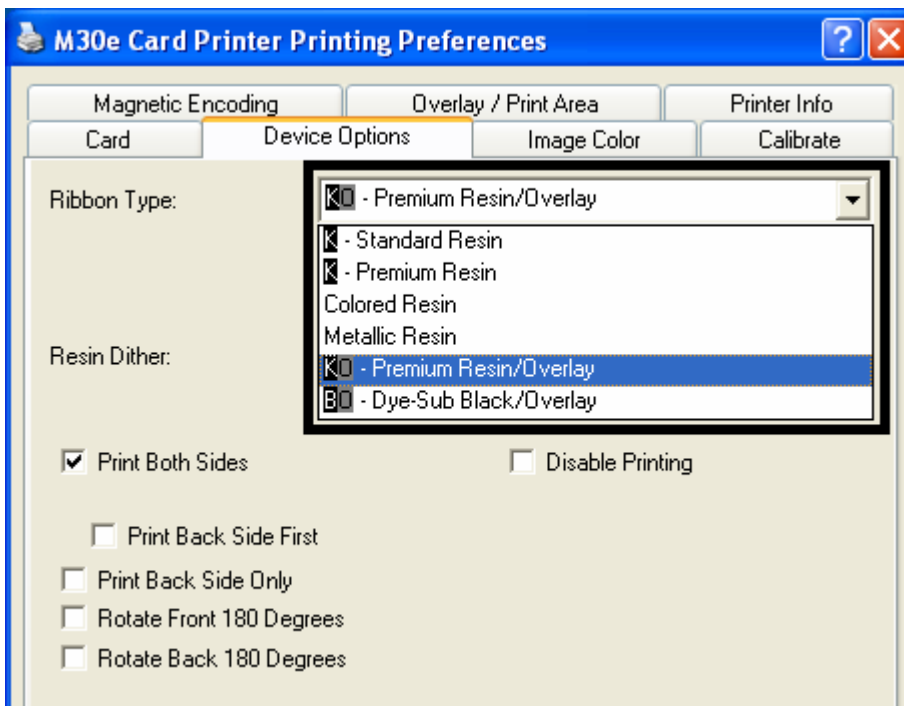

## Selecting the Auto Ribbon Select option

Step	Description
1	Click <b>Auto Ribbon Select</b> to verify that the Ribbon type selected matches the Ribbon installed in the Printer. ( <b>Note:</b> The Printer Driver will change the Ribbon type to the correct setting or validate. It will also display a dialog that it has changed the current setting or that the current Ribbon type is correct.)
2	Click <b>Test Print</b> to send a simple self-test print to the DTC400e/C30ePrinter. <ul style="list-style-type: none"> <li>• Ensure that an YMCKO Ribbon is installed.</li> <li>• Ensure that the computer is effectively communicating with the Printer and that the Printer is functioning properly.</li> </ul> Ensure that an <b>YMCKOK</b> Ribbon is installed in order for a DTC400e/C30e Card Printer with a Flipper Table Module to print a dual-sided image.

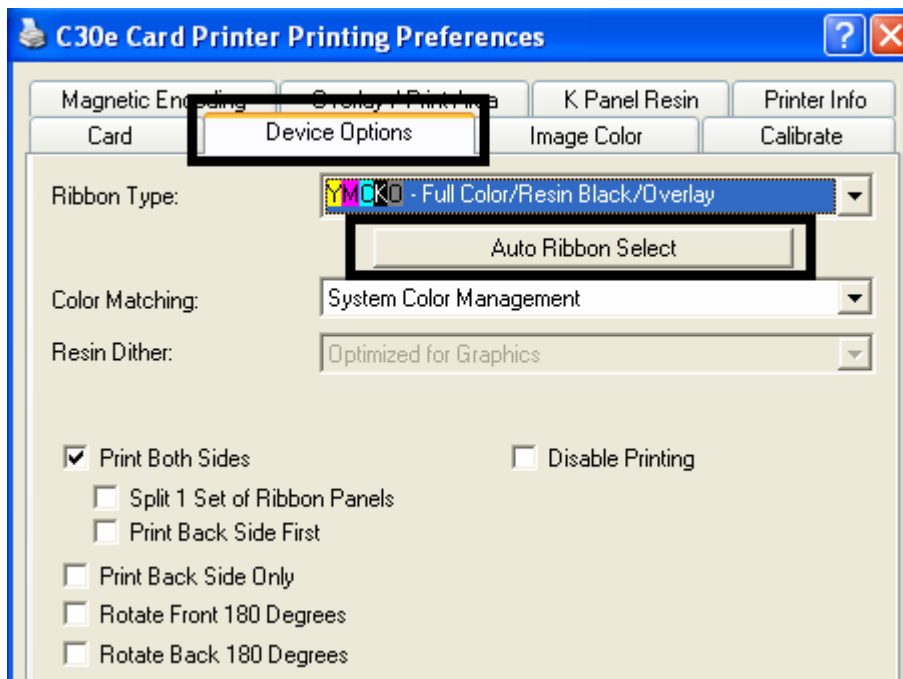

3	<p>Click <b>Test Print</b> to send a simple self-test print to the M30e Printer.</p> <ul style="list-style-type: none"><li>• Ensure that the Premium Resin Ribbon is installed for M30e</li><li>• Ensure that the computer is effectively communicating with the Printer and that the Printer is functioning properly.</li></ul>
---	--

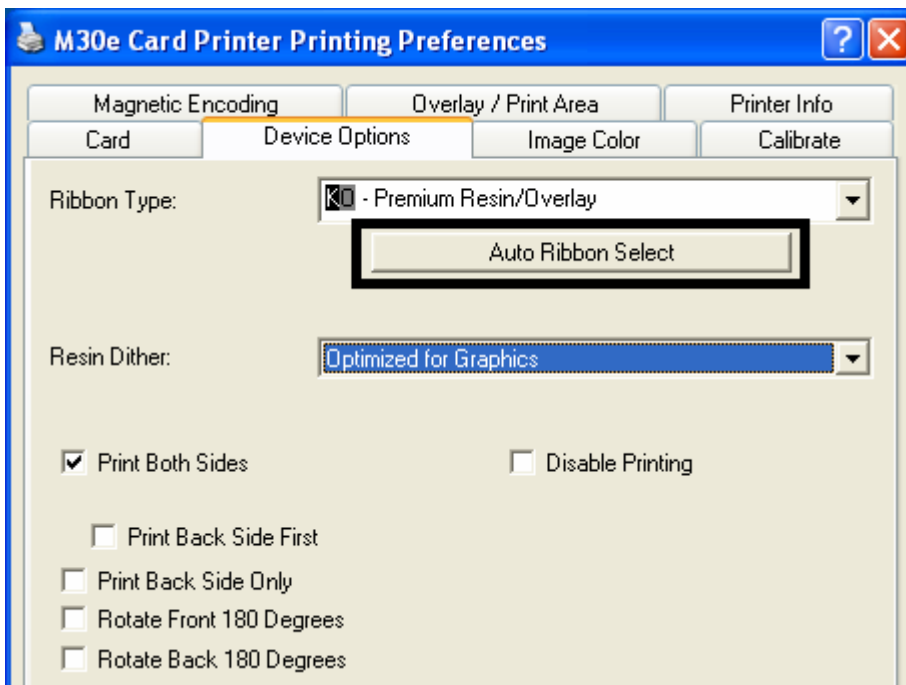

## Changing the Color Profile Selection for the DTC400e/C30e

Step	Procedure
1	a. From your computer's startup menu, select Settings > Printers and Faxes (Windows XP) or Settings > Printers (Windows 2000). b. Double click on the DTC400e/C30e Card Printer under the Printers window. c. Select Properties under the Printer drop-down menu. ( <b>Note:</b> This will bring up the DTC400e/C30e Card Printer Properties window, as shown on the next page.)
2	Click the <b>Color Management</b> tab.
3	Click <b>Manual</b> .
4	Click DTC400e/C30e CLR_E for improved color matching. ( <b>Note:</b> This color profile has better screen to printer matching.)  <b>OR</b> Click DTC400e/C30e CLR_O if you already have an existing base of cards using this color profile, and you want to maintain the same color matching. <b>(Note:</b> If the DTC400e/C30e CLR_O color profile is not listed, it can be added by clicking <b>Add</b> and browsing to Program Files\Fargo\Printer Driver Software\DTC400e/C30e Driver Files and selecting DTC400e/C30e CLR_O.icm.)
5	Click <b>Set as Default</b> .

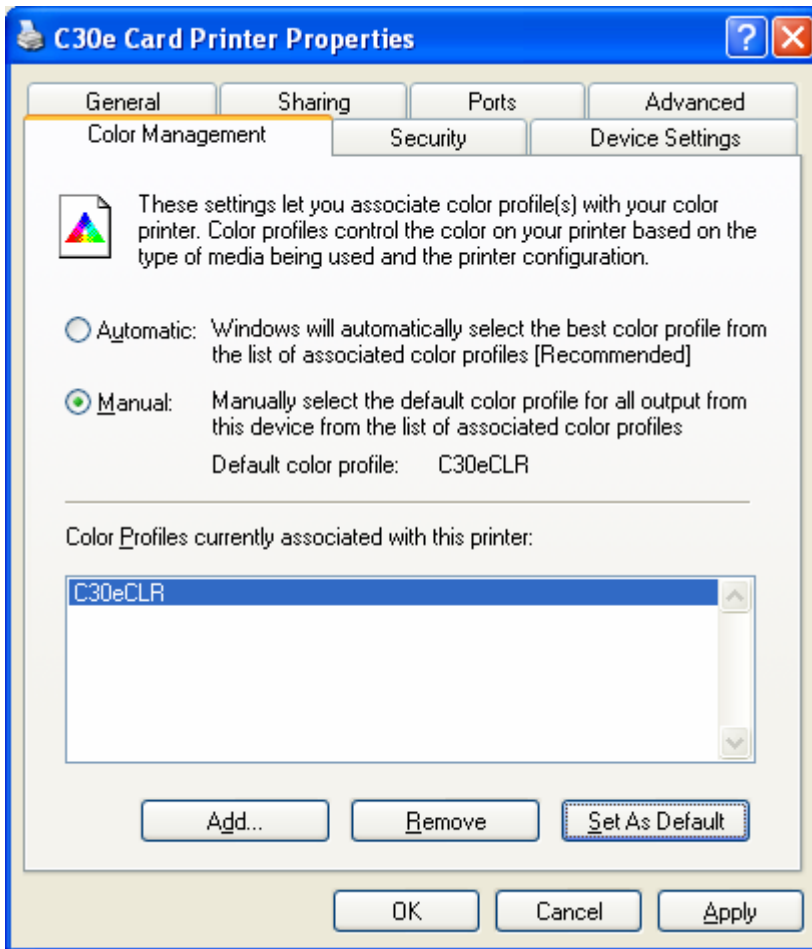

## Adjusting the Color Matching option

Use the **Color Matching** dropdown menu to choose the color matching options which best fits the print job requirements.

Step	Description
1	<p>Select <b>None</b> for print speed versus print color or for use of third party color matching software.</p> <p><b>OR</b></p> <p>Select <b>Algebraic</b> (a) for the Printer Driver to make very simple, yet fast, color balance adjustments; (b) for more natural looking images without actually utilizing any specific color matching; or (c) for customized, printed coloring of the cards through the Image Color tab.</p> <p><b>OR</b></p> <p>Select <b>Monitor</b> for the Printer Driver to make color corrections similar to the Algebraic option but through a more complex color matching algorithm.</p> <p><b>OR</b></p> <p>Select <b>System Color Management</b> for Windows to make color corrections. This provides a closer match to the sRGB color specifications. (<b>Note:</b> This option shifts colors to a different color model so the colors in the image will more closely match how they appear on the monitor.)</p>

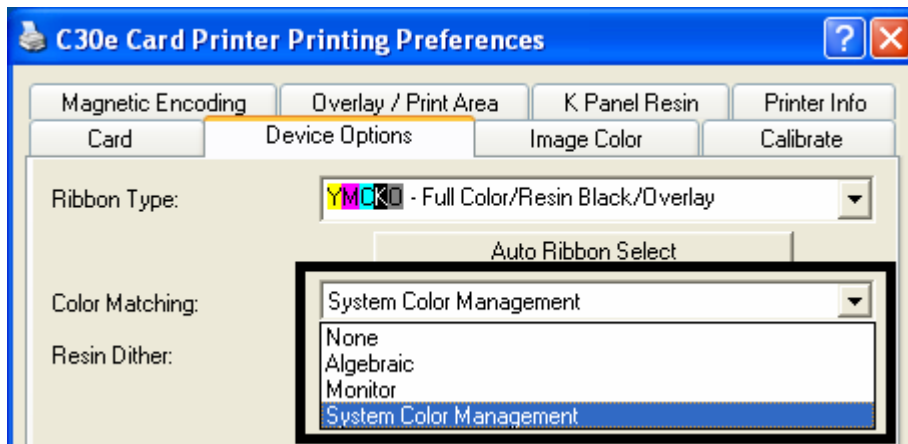



## Adjusting for the Resin Dither

Select the appropriate dither method according to the type of image to be printed. This option affects objects printed with a resin-only print Ribbon.

Step	Procedure
1	Select <b>Optimized for Photo</b> when printing photo quality images with resin. <b>OR</b> Select <b>Optimized for Graphics</b> when printing drawings and graphics (e.g., clipart, logos, etc.) with resin.

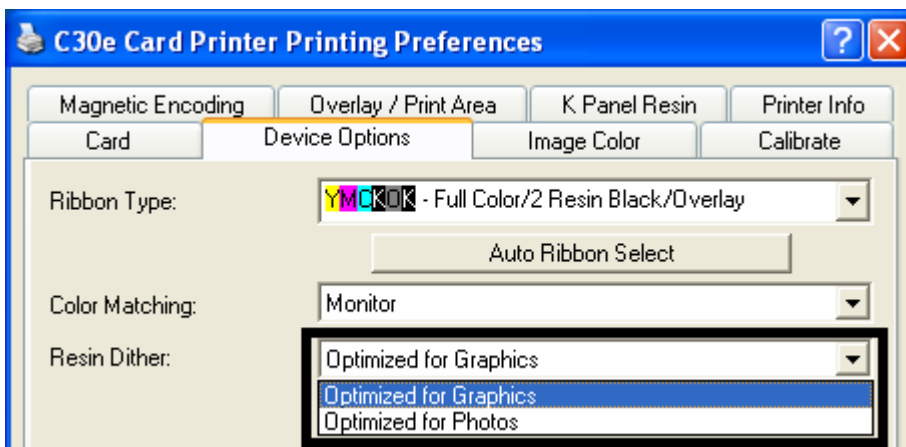

## Using the Print Both Sides option

Use this option to automatically print on both the front and back of a card.

Step	Procedure
1	Select this option in conjunction with any application program that supports a multiple-page document with duplex printing. ( <b>Note:</b> The program must be able to send down two or more separate pages to be printed within the same document.)
2	<ul style="list-style-type: none"> <li>• Page 1 will be transferred to the front side of the card.</li> <li>• Page 2 will be transferred to the backside of the card.</li> </ul> <p>(<b>Note:</b> The Printer Driver will always place all odd numbered pages on the front side of the card and all even numbered pages on the back side with this option selected. If an odd number of pages are printed to the Driver while this option is selected, then the Printer will print an additional blank side, and transfer it to the card.)</p>

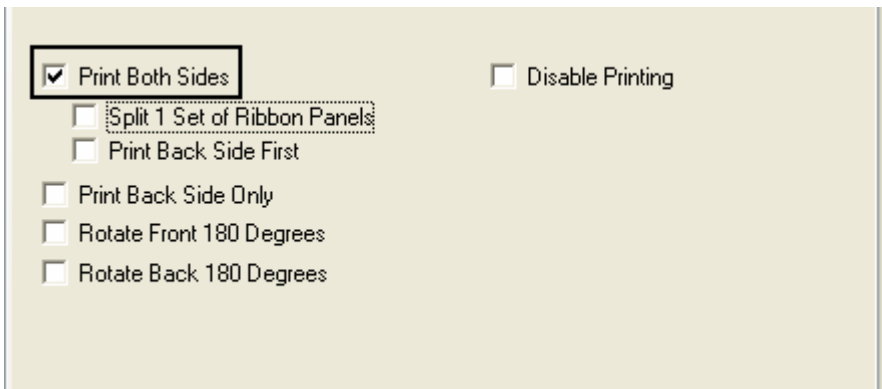

## Using the Split 1 Set of Ribbon Panels option

Use this option to provide the most economical means of printing a dual-sided card since a single set of Ribbon Panels will be split to print both the front and backsides of a card.

Step	Procedure
1	<p>Select this option to automatically print full-color on the front of a card and resin black on the back of a card (using either of the Full-color YMCKO or YMCKOK Print Ribbons).</p> <ul style="list-style-type: none"> <li>• If using the YMCKO Ribbon type, the front of the card is printed with the Ribbon's YMC Panels and the back is printed with the K Panel, and the O Panel is printed on the front.</li> <li>• If using the YMCKOK Ribbon type, the front of the card is printed with the YMCKO Panels and the back is printed with the second K Panel.</li> </ul> <p><b>(Note #1:</b> This option is automatically enabled when the YMCKOK Ribbon type is selected.)</p>

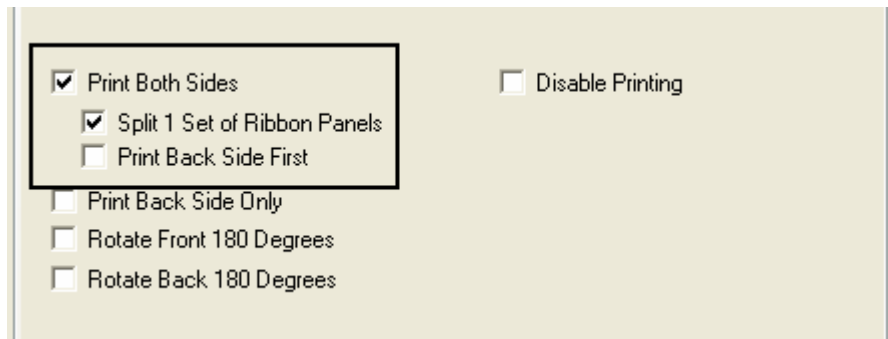

## Using the Print Back Side First option

Step	Procedure
1	<p>Select this option:</p> <ul style="list-style-type: none"> <li>• If you need to print the first page of a two-page document on the backside of the card.</li> </ul> <p style="text-align: center;"><b>OR</b></p> <ul style="list-style-type: none"> <li>• If you need to print the resin black on the chip-side of the Smartcard.</li> </ul> <p>The second page of the document will be printed on the front side of the card.</p>

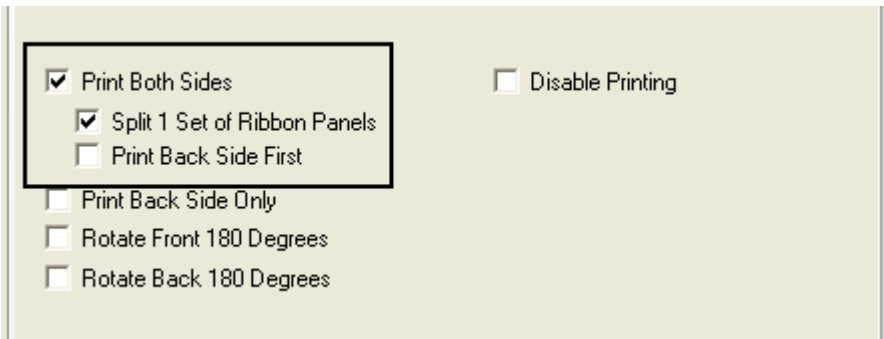

## Using the Print Back Side Only option

Use this option to print only onto the backside of cards.

Step	Procedure
1	<p>Select this option to print only onto the back of a card. (<b>Note:</b> Load the cards in the standard manner.)</p> <ul style="list-style-type: none"><li>• When this option is selected, the <b>Print Both Sides</b> option is automatically disabled.</li><li>• When attempting to print a two-page document (if <b>Print Back Side Only</b> is selected), the first page of the document will print on the backside of the card.</li><li>• The second page of the document will then be printed on the back of a second card.</li></ul>

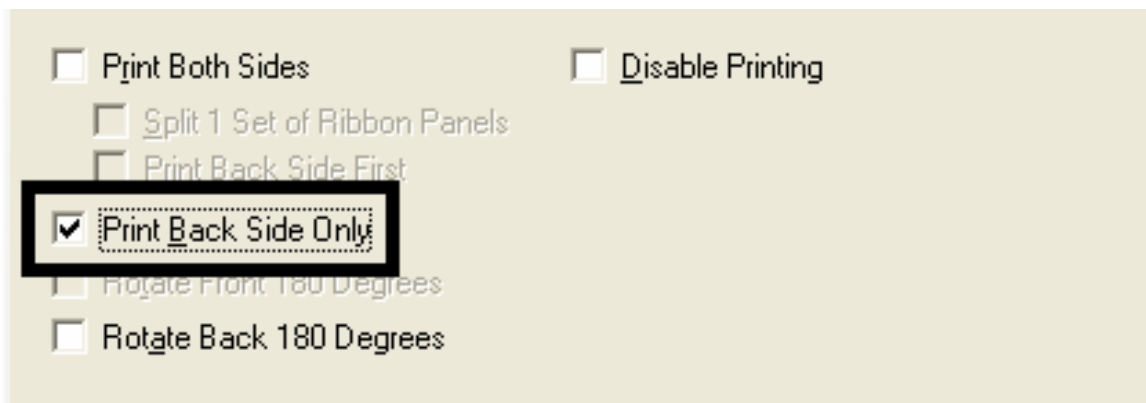

## Using the Rotate Front 180 Degrees or Rotate Back 180 Degrees options

Use this option to change the position of the printed image in relation to the location of a card's Magnetic Stripe or smart chip.

Step	Procedure
1	<p>Select <b>Rotate Front 180 Degrees</b> to rotate the image on the front of the card by 180 degrees when printed.</p> <p><b>OR</b></p> <p>Select the <b>Rotate Back 180 Degrees</b> to rotate the image on the back of the card by 180 degrees when printed.</p>

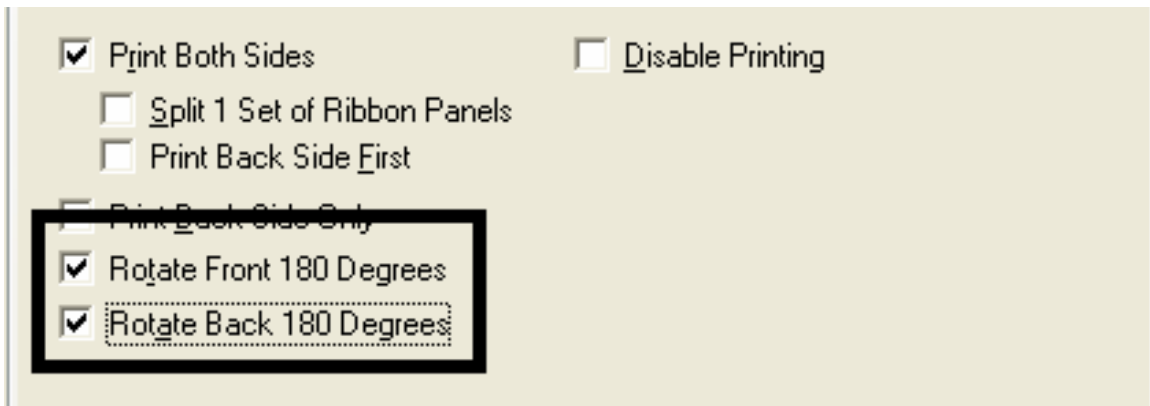

## Using the Disable Printing option

Use this option to disable the printing capabilities of the Printer. (**Note:** This option still allows the Printer to encode cards.)

Step	Description
1	Select <b>Disable Printing</b> to encode or re-encode cards to save time and avoid the use of printing supplies. ( <b>Note:</b> When this option is selected, no print data will be sent to the Printer. All encoding instructions will be sent according to how they are configured within the software.)

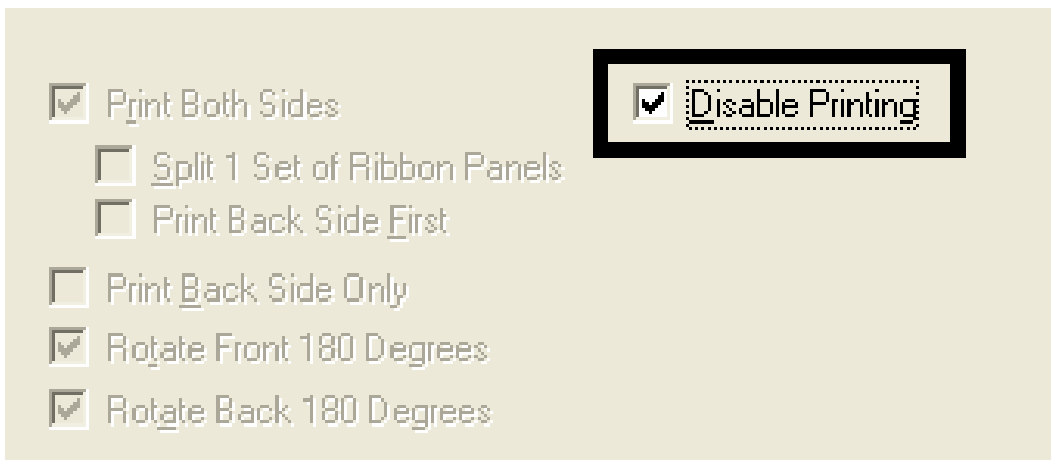

## Using the Image Color tab (DTC400e/C30e/M30e)

Step	Procedure
1	Select <b>Algebraic</b> and then use this option to control the <b>Contrast</b> and <b>Gamma</b> of the printed image, as well as the individual color balance of <b>Yellow</b> , <b>Magenta</b> and <b>Cyan</b> . ( <b>Note:</b> In most cases, the default settings of these options will suffice.)
2	<p>Control the overall darkness and lightness of the printed image by adjusting the <b>Dye-Sub Intensity</b> slider.</p> <ul style="list-style-type: none"> <li>• Move the slide to the left to cause less heat to be used in the printing process, thus generating a lighter print.</li> <li>• Move the slide to the right to cause more heat to be used, thus generating a darker print. (<b>Note:</b> This slide only affects those images printed with dye-sublimation Ribbon panels (YMC).)</li> </ul>

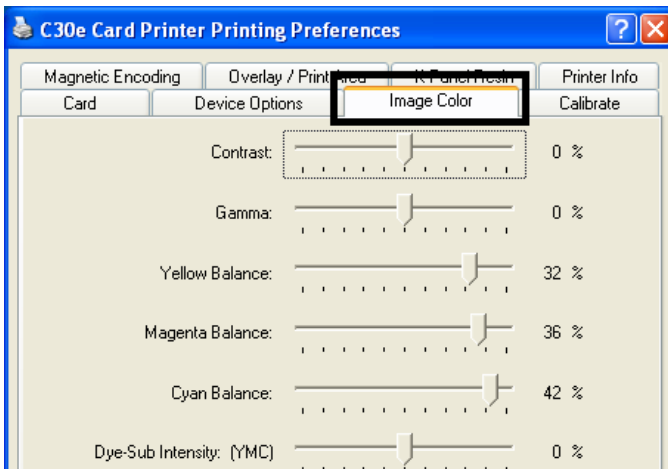

C30e

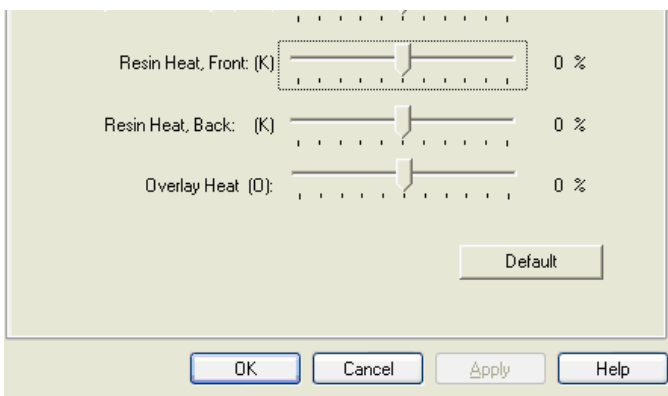

M30e



### Using the Resin Heat (K) option (Front and Back)

Use this option to control the amount of heat the Printer uses when printing with the resin black panel(s) of a full-color Ribbon or when printing with a resin-only Ribbon by adjusting the **Resin Heat** slide.

Step	Procedure
1	<p>Adjust the Resin Heat, Front (K) or the Resin Head, Back (K) as needed.</p> <ul style="list-style-type: none"> <li>• Move the slide to the left to cause less heat to be used in the printing process, causing resin images to be lighter or less saturated.</li> </ul> <p><b>OR</b></p> <ul style="list-style-type: none"> <li>• Move the slide to the right to (a) cause more heat to be used or (b) cause the resin image to be darker or more saturated.</li> </ul> <p>(<b>Note:</b> This control can be helpful for fine-tuning the transfer of resin text and bar codes.)</p>

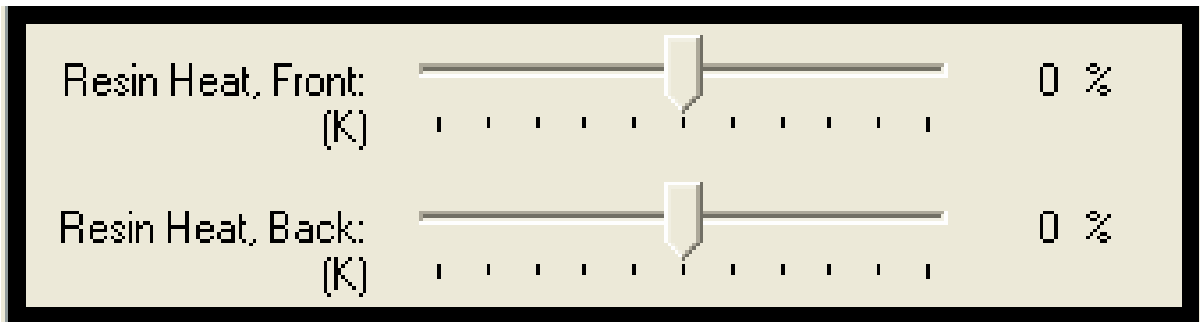

## Using the Overlay Heat (O) option

Use this option to control the amount of heat the Printer uses when printing with the overlay panel of a Ribbon. **(Note:** This control can be helpful for fine-tuning the transfer of overlay onto the card.)

Step	Procedure
1	Move the slide to the left to cause less heat to be used in the printing process. <b>(Note:</b> Certain card types may need additional heat for better transfer of the overlay material.)  <b>OR</b> Move the slide to the right to cause more heat to be used.

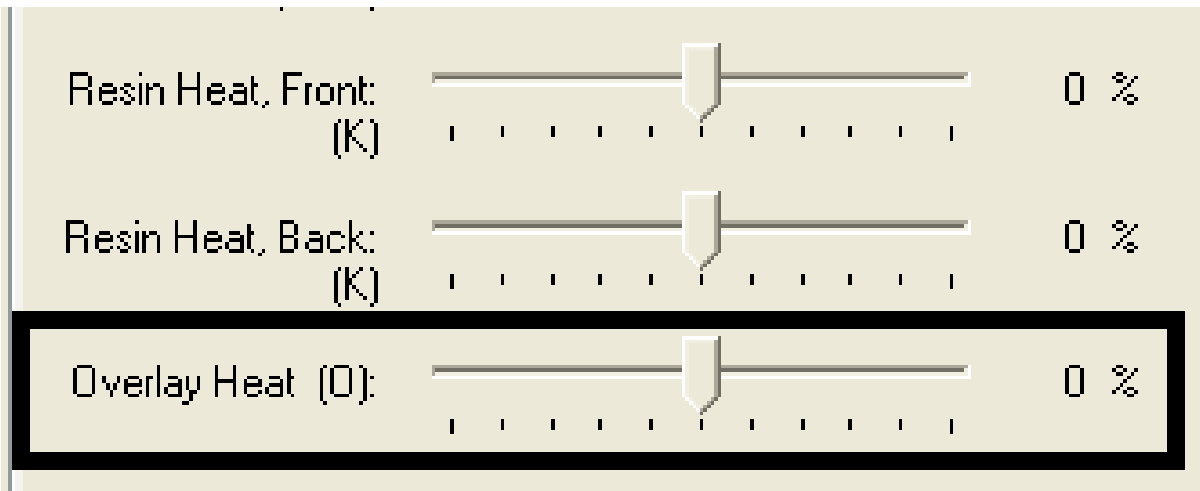

### Using the Color Matching option and Default button

Step	Procedure
1	To return all options to their factory settings, click <b>Default</b> .

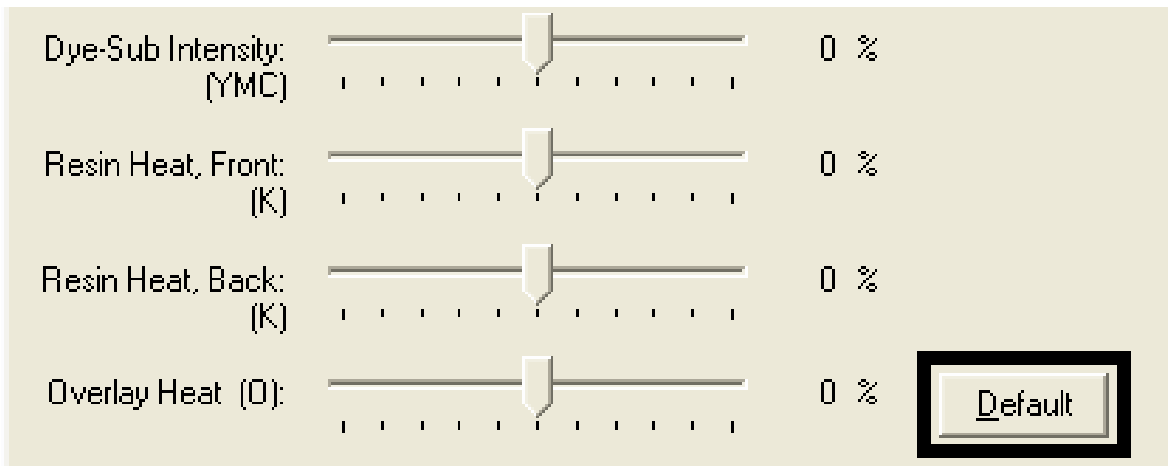

DTDC400e/C30e

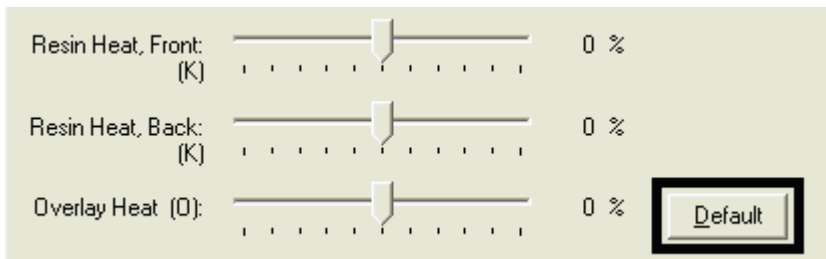

M30e

## Using the Calibrate tab (DTC400e/C30e/M30e)

Use the Calibrate tab to (a) control the position of the printable area in relation to the card, (b) calibrate Sensors and (c) adjust the internal Printer settings that are customized for every Printer and saved directly within the Printer's memory.

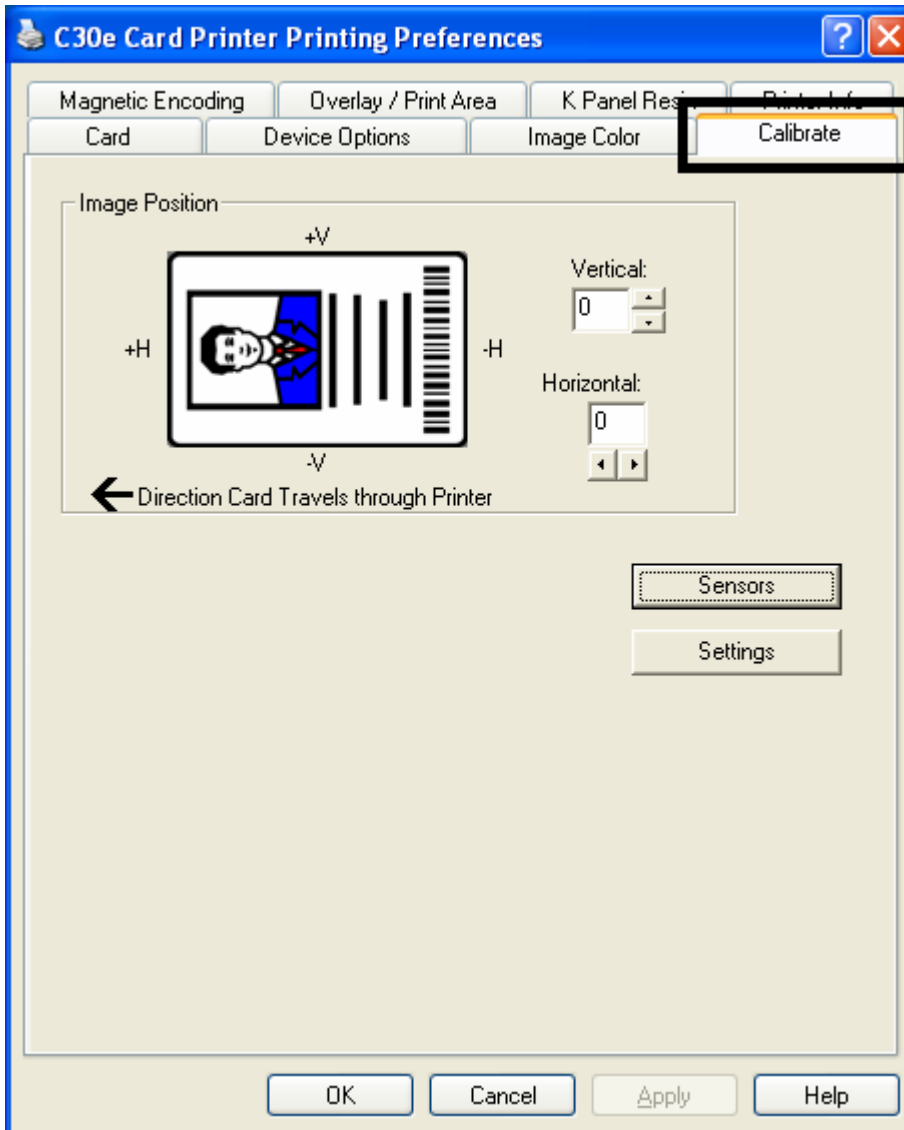

## Using the Image Position Controls

Use the **Image Position** controls to adjust the position of the overall print area to be precisely centered on a card.

Step	Procedure
1	<p>Click the <b>Vertical</b> and <b>Horizontal</b> adjustment arrows to adjust the Image Position values.</p> <ul style="list-style-type: none"> <li>When adjusting these values, keep in mind that the card always remain in the same position while moving through the Printer, regardless of image orientation.</li> <li>To illustrate this, the card illustration shown in the Image Position box will flip and rotate according to the <b>Portrait, Landscape or Rotate 180 Degrees</b> selection.</li> <li>The outline around the illustration will always remain in the same <b>Landscape</b> orientation.</li> </ul>

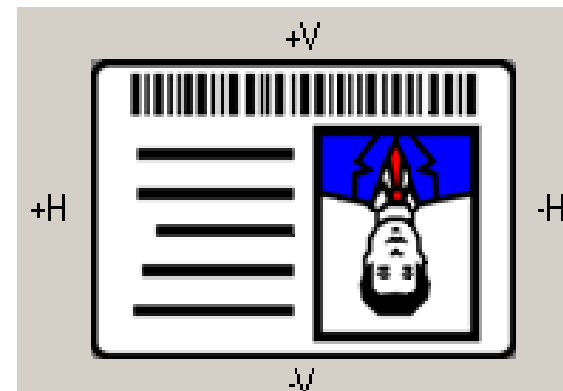
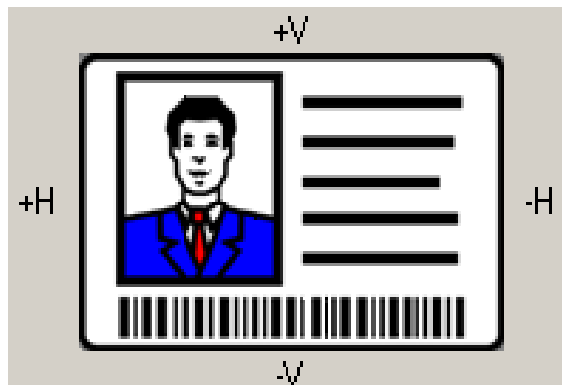
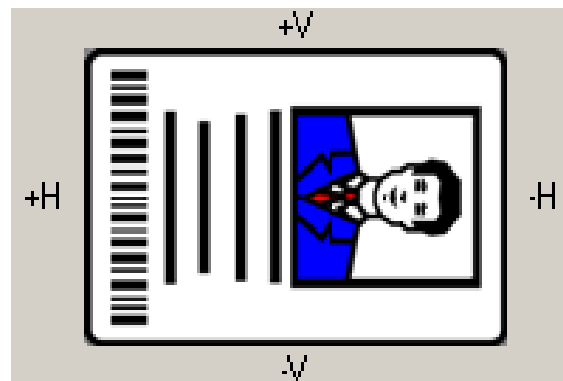
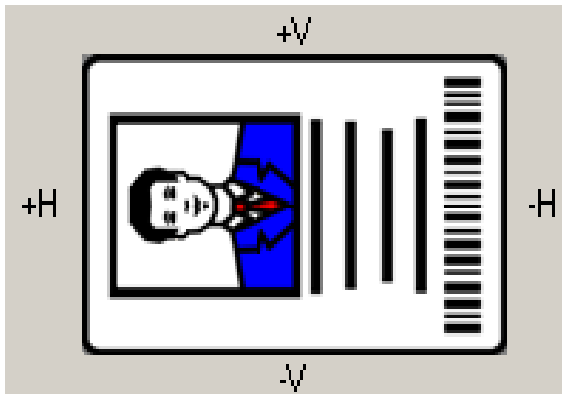

Review the Image Position diagram, which displays how the printed image will move in relation to the fixed card position as positive and negative image placement values are entered.

Step	Procedure
2	<p>Use the <b>Vertical</b> adjustment to move the image:</p> <ul style="list-style-type: none"> <li>• Move toward the rear of the Printer if a positive number is entered.</li> <li>• Move toward the front of the Printer if a negative number is entered.</li> </ul> <p><b>OR</b></p> <p>Use the <b>Horizontal</b> adjustment to move the image:</p> <ul style="list-style-type: none"> <li>• Move toward the card output side of the Printer if a positive number is entered.</li> <li>• Move toward the card input side of the Printer if a negative number is entered.</li> </ul> <p>(<b>Note No.1:</b> The maximum value for the <b>Vertical</b> and <b>Horizontal</b> adjustments is <math>\pm 100</math> pixels (10 pixels = about .03"/. 8mm).)</p> <p>(<b>Note No.2:</b> The <b>Vertical</b> and <b>Horizontal</b> adjustment arrows point to within the Image Position window, which represents the direction that the printed image moves.)</p>

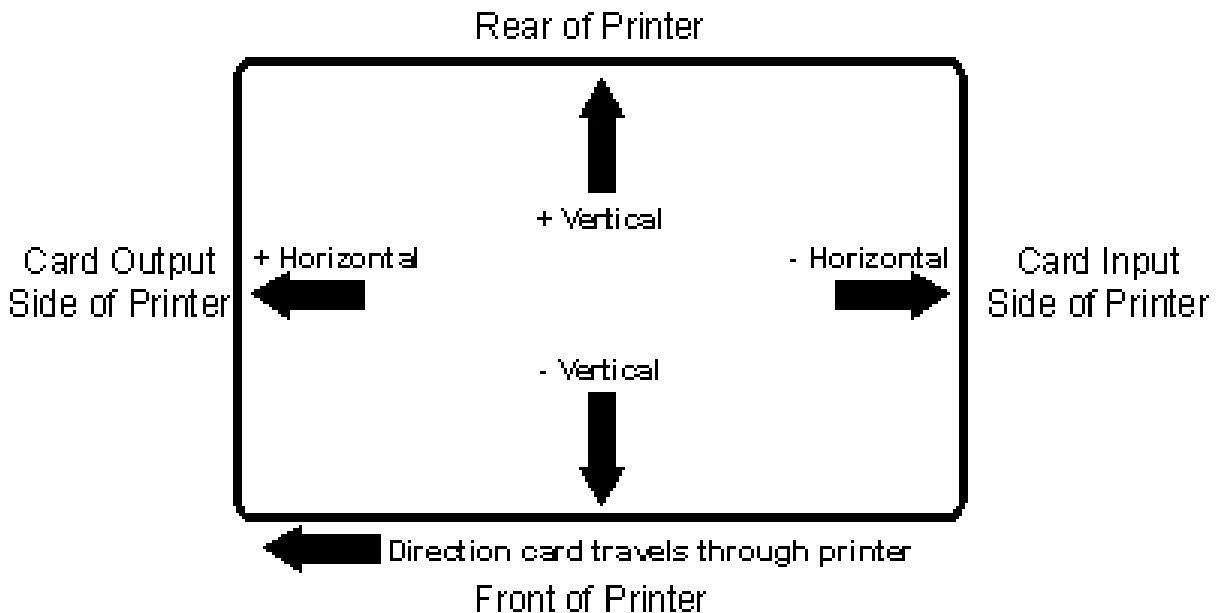

## Using the Sensors button

Use the **Sensors** button to bring up a separate dialog box for calibrating the Printer's Ribbon Sensor (see instructions in the Calibration window below).

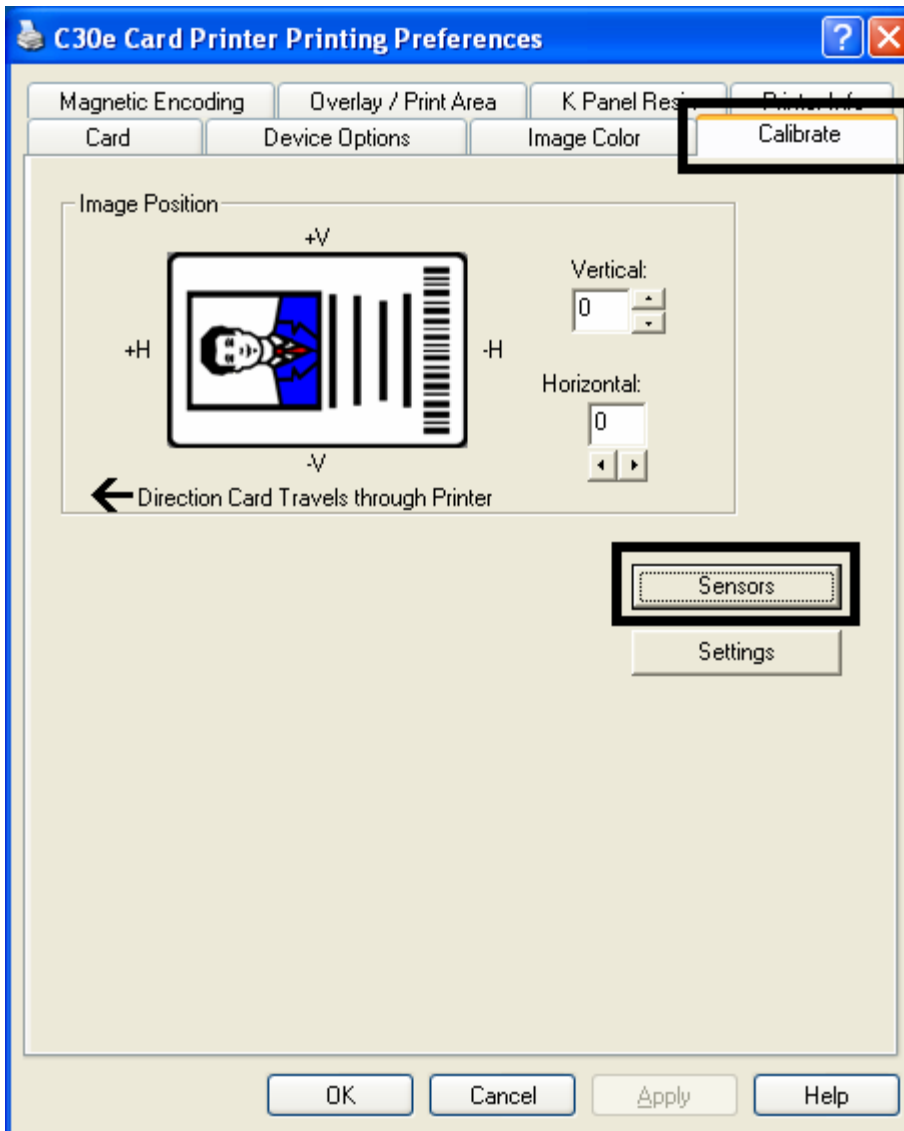

## Using the Sensors button

See the previous page for the related procedure.

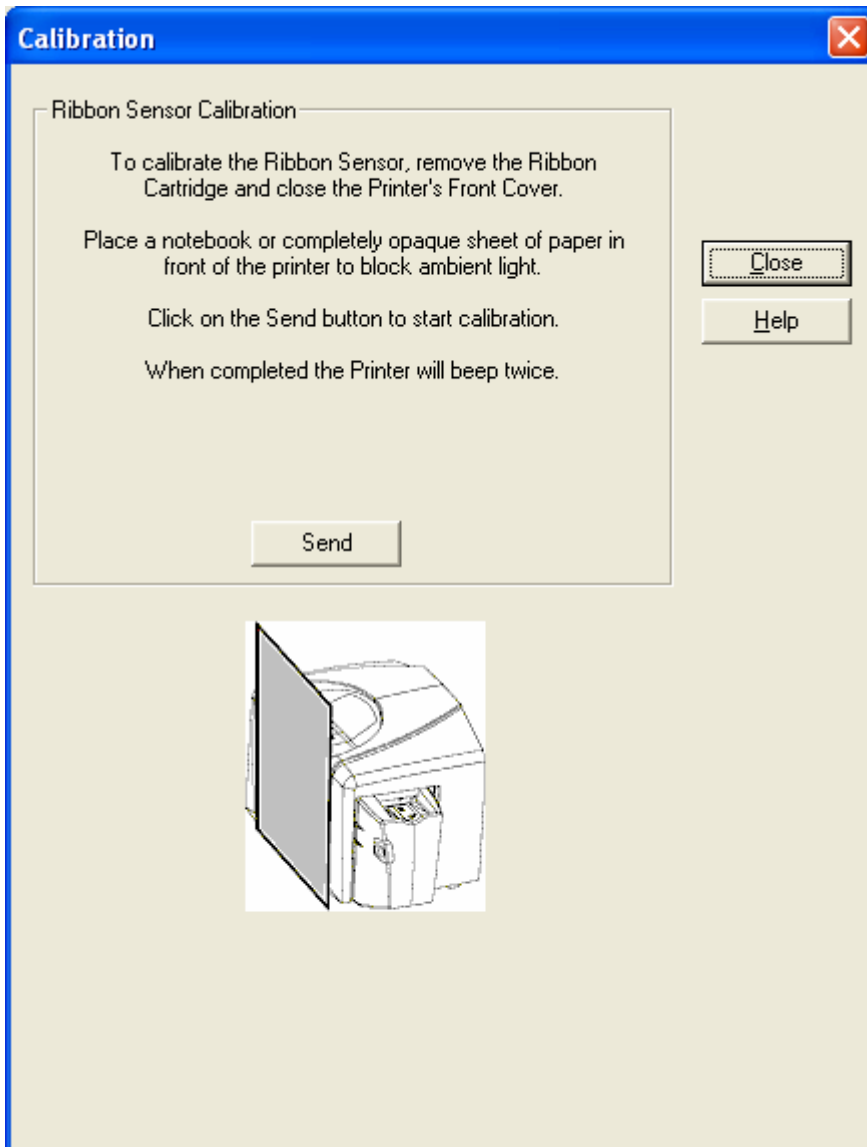



## Using the Settings button

Use the **Settings** button to bring up a dialog for adjusting the internal Printer settings, which are customized for every Printer at the factory and saved directly within the Printer's memory. (**Note:** You can select the Restore Defaults to restore the internal default settings.)

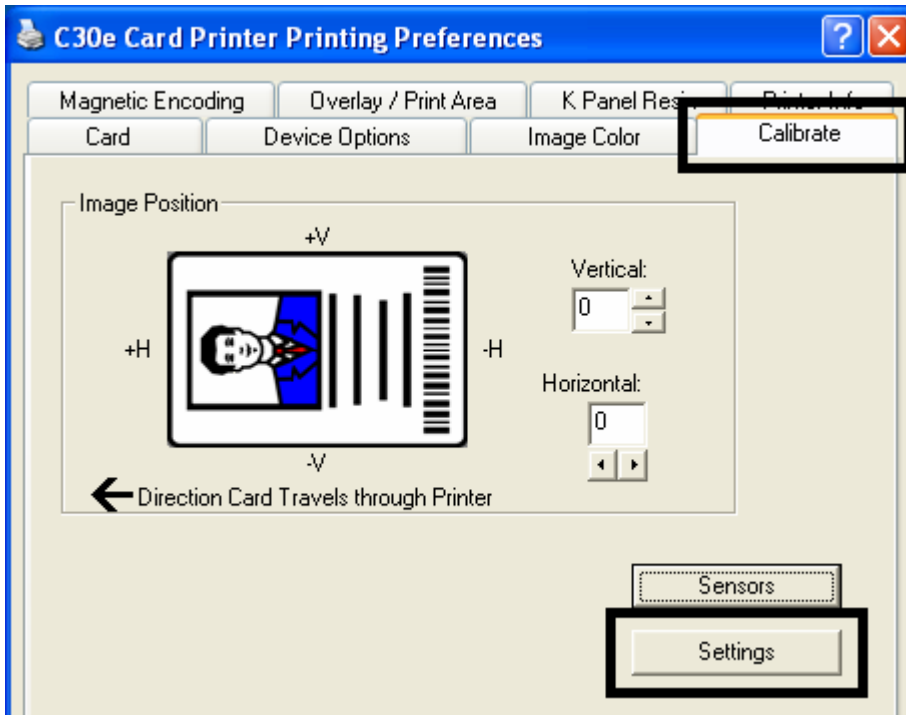

## Using the Magnetic Encoding tab

Use these options only if the Printer has an optional Magnetic Stripe Encoding Module installed.

Step	Procedure
1	Select the <b>Magnetic Encoding</b> tab to display options for controlling the Magnetic Stripe encoding process. ( <b>Note:</b> The following describes these options and the Printer's magnetic encoding process.)

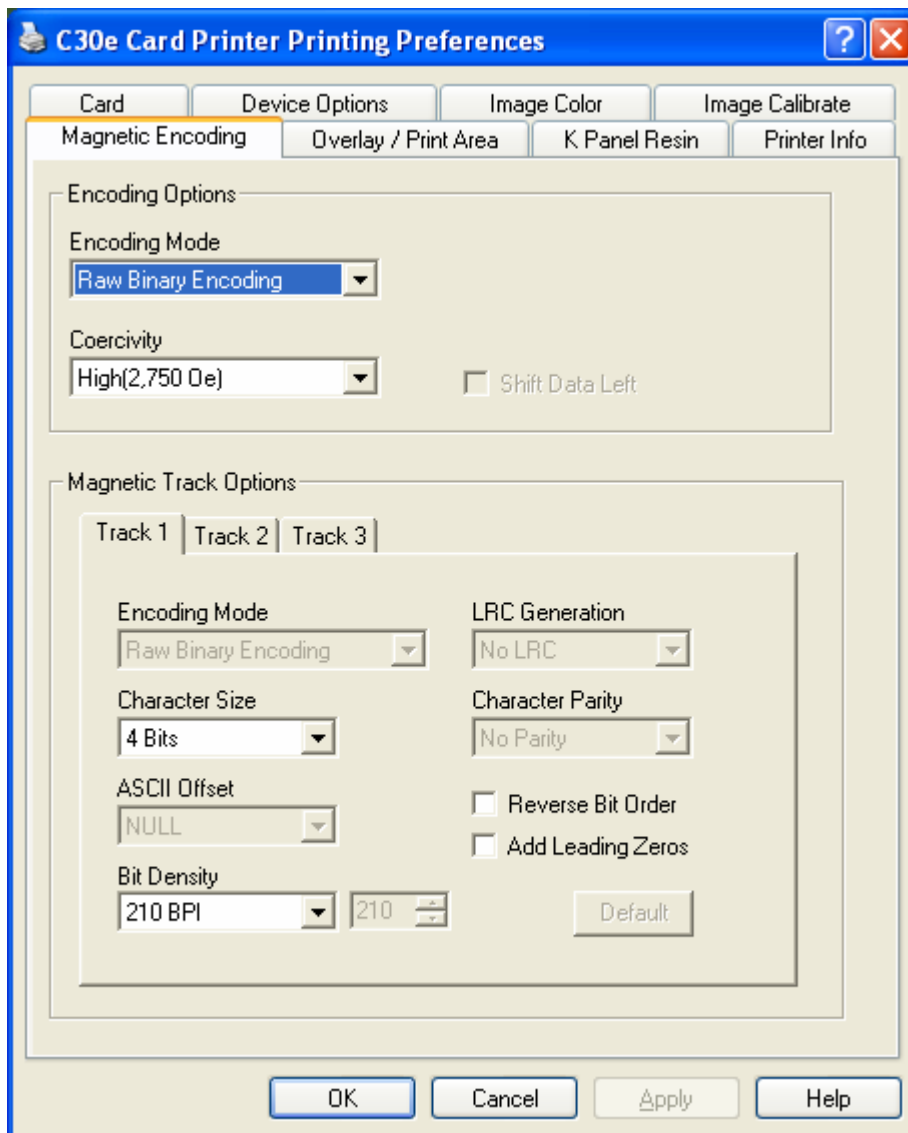

## Using the Encoding Mode dropdown list

You can use the **Encoding Mode** option in order to specify which magnetic encoding standard to use.

Category	Description
Installation	The DTC400e/C30e/M30e Card Printer can be installed with one of two types of factory installed Magnetic Stripe Encoding Modules.
<b>Magnetic Encoding</b> options (changing and modifying)	Change the encoding mode and coercivity setting or modify the ISO standards for Tracks 1, 2 and 3. This can be done by correctly modifying these Magnetic Encoding options.

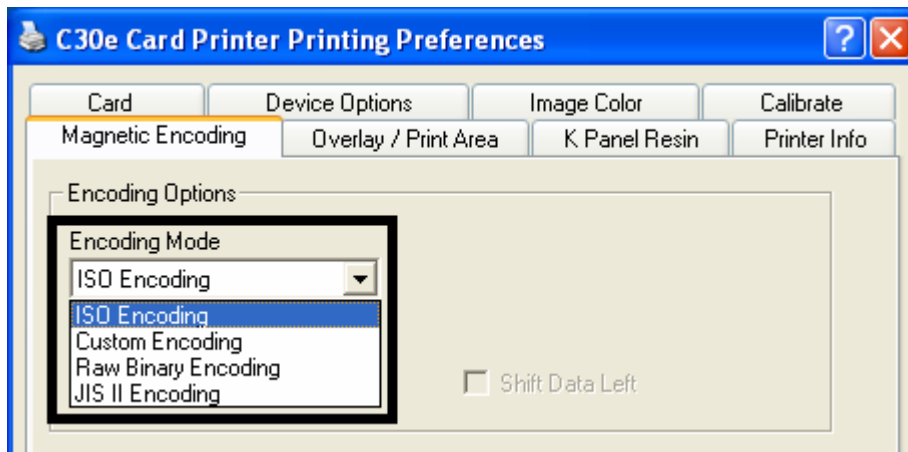

**ISO Encoding**  
selection (active  
and inactive  
functions)

If you select **ISO Encoding**, you send down a formatted set of characters. (**Note:** This selection activates the track tabs. However, all functions on the Track tabs are inactive or gray and display ISO defaults, which are the defaults listed for each track below. The **Shift Data Left** check box remains unchecked and inactive.)

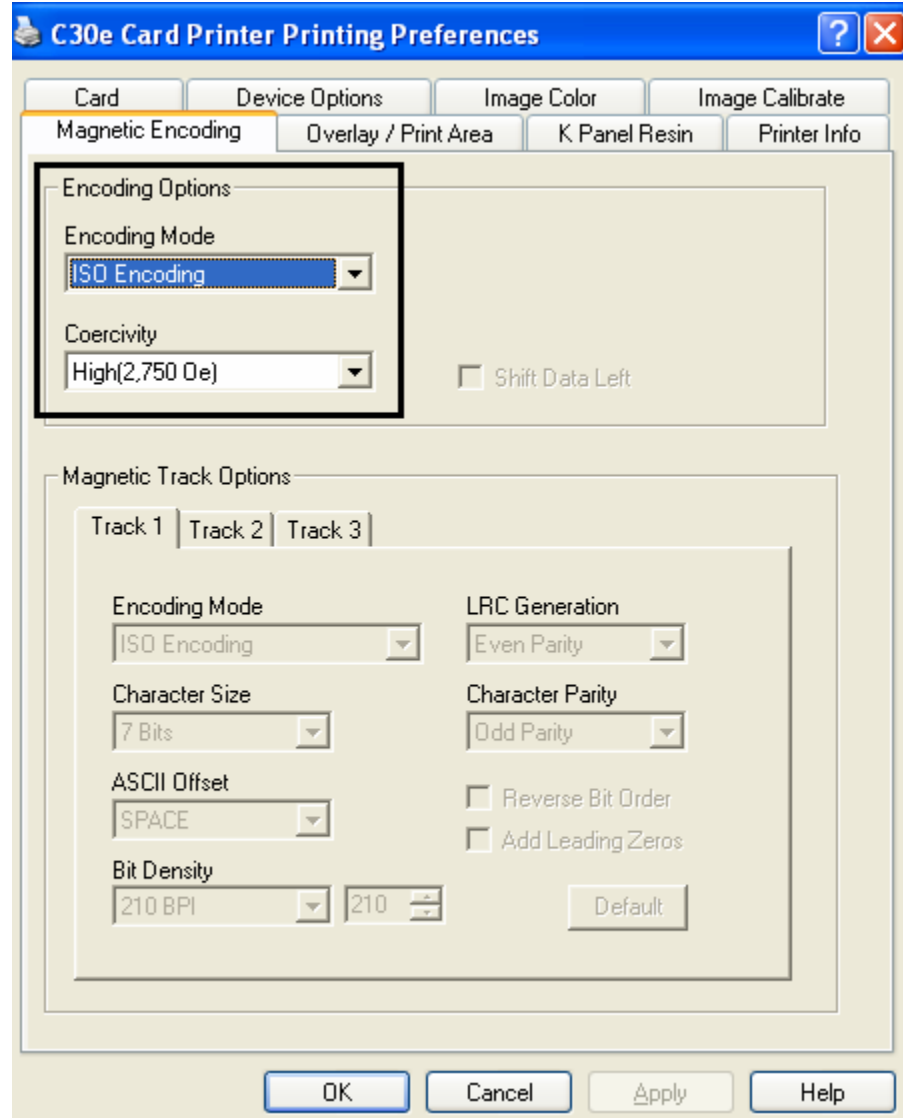

**Custom Encoding**  
selection (active and inactive functions)

If you select **Custom Encoding**, all options are active. The Default is ISO Encoding. (**Note:** The defaults are the same as the ISO Encoding defaults. However, all functions on the Magnetic Track Options tabs are active.)

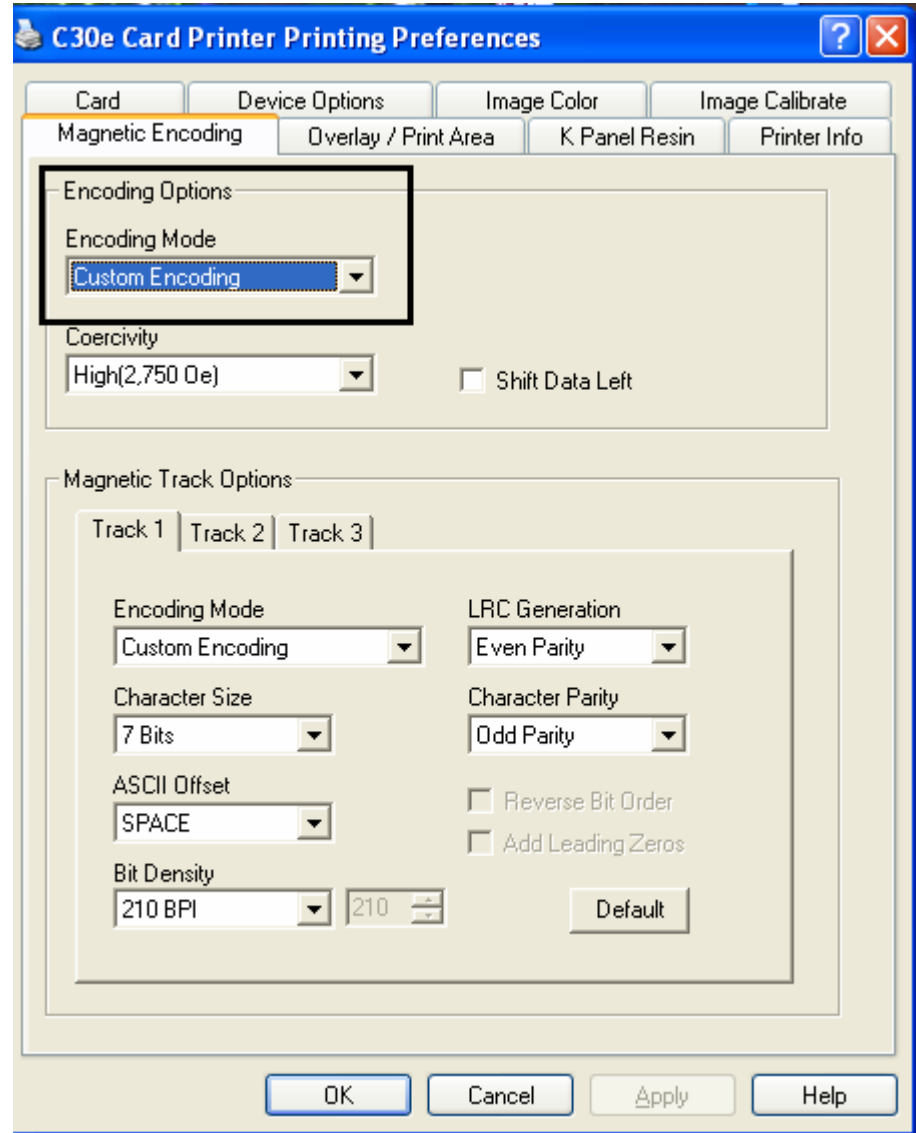

**Raw Binary Encoding**  
selection (active and inactive functions)

If you select **Raw Binary Encoding**, you send down a raw binary string rather than a formatted set of characters. (**Note:** The **Coercivity** dropdown function is active and the Bit Density, Character Size, Reverse Bit Order and Add Leading Zeros are also active when Raw Binary Encoding is selected.

**Reverse Bit Order** is used to reverse the character bits and is used for the encryption of data in specific programs

**Add Leading Zeros** is used to add a set number of leading zeros to the magnetic string in order to move the starting point of the encoded data in specific programs for encryption of data.

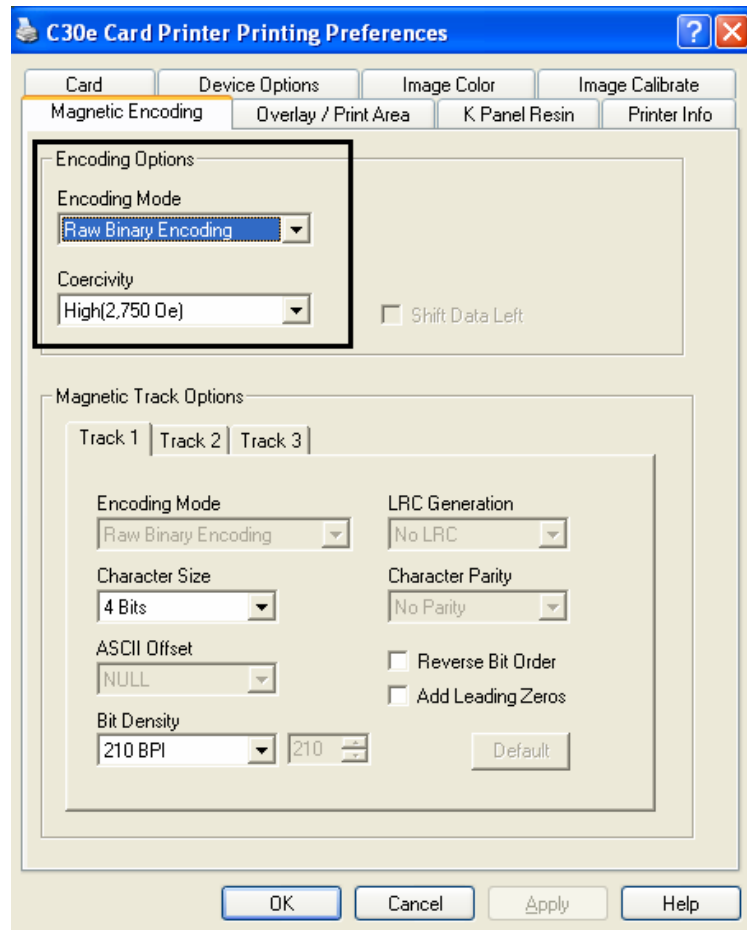

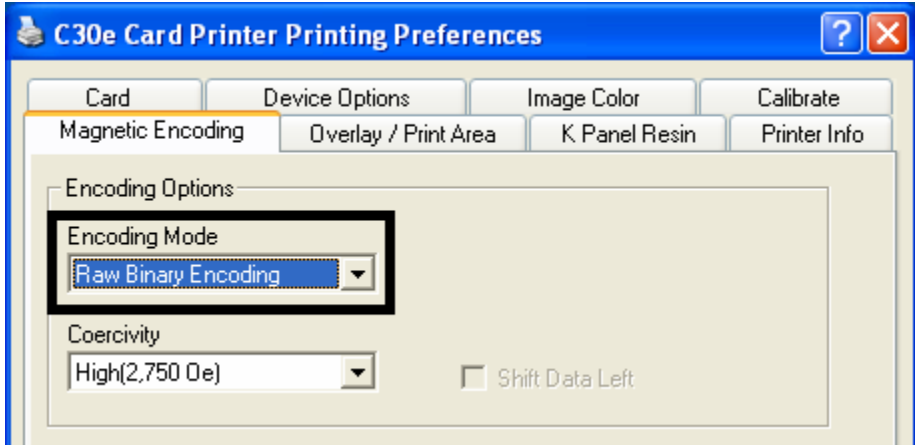
<p><b>Raw Binary Encoding</b> selection (continued from the previous page)</p>	<p><b>Raw Magnetic Encoding</b> The User can select <b>Raw Magnetic Encoding</b> from the Driver.</p> <p><b>Raw Coercivity</b> The User can select options for either <b>High</b> or <b>Low Coercivity</b> from the Driver.</p> <p><b>Raw Bit Density</b> The User can select the <b>Configurable Bit Density</b> option. This option supports these standard configurable bit densities:</p> <ul style="list-style-type: none"><li>• 75 Bits Per Inch (BPI)</li><li>• 128 BPI</li><li>• 210 BPI</li><li>• Custom BPI</li></ul> <p><b>Raw Bit Density Per Track</b> The User can select the Configurable Bit Density, Character Size, Reverse Bit Order and Add Leading Zero options for each individual magnetic encoding track.</p> 
--	--

**JIS II Encoding**  
selection (active  
and inactive  
functions)

If you select **JIS II Encoding**, specific standards are used. (**Note:** This selection disables all the Magnetic Track Options tabs. It also disables the Coercivity dropdown function and **Shift Data Left** checkbox option.)

- The default Coercivity is 600 Oe.

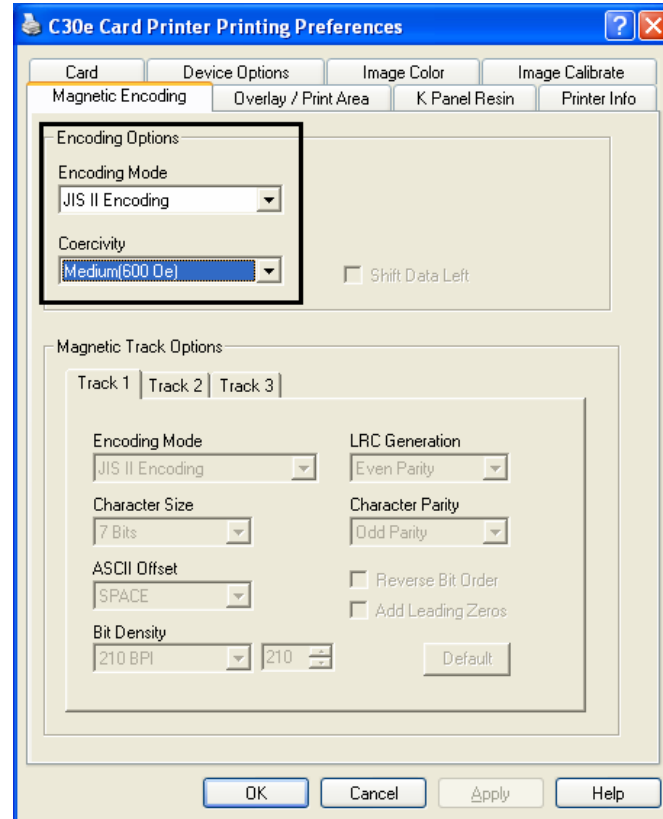



## Selecting the Coercivity/Magnetic Track

You can use the **ISO** option for encoding capability for either high- or low-Coercivity cards on Tracks 1, 2 and 3. This is the industry's standard mode of magnetic encoding.

Step	Procedure
1	Select the <b>Coercivity</b> option (Oersted) to use the Magnetic Stripe type that matches the card type. <ul style="list-style-type: none"> <li>• High Coercivity to Super Coercivity = 2750-4000 Oersted (Fargo's High Coercivity UltraCard IIIs are 2750 Oe)</li> <li>• Medium Coercivity = 600 Oersted</li> <li>• Low Coercivity = 300 Oersted</li> </ul>
2	Select the <b>Magnetic Track Selection</b> option to specify which track is to be configured through the Magnetic Track Options (if the application being used requires customization of the standard ISO encoding process). See Reviewing the Magnetic Track Options.

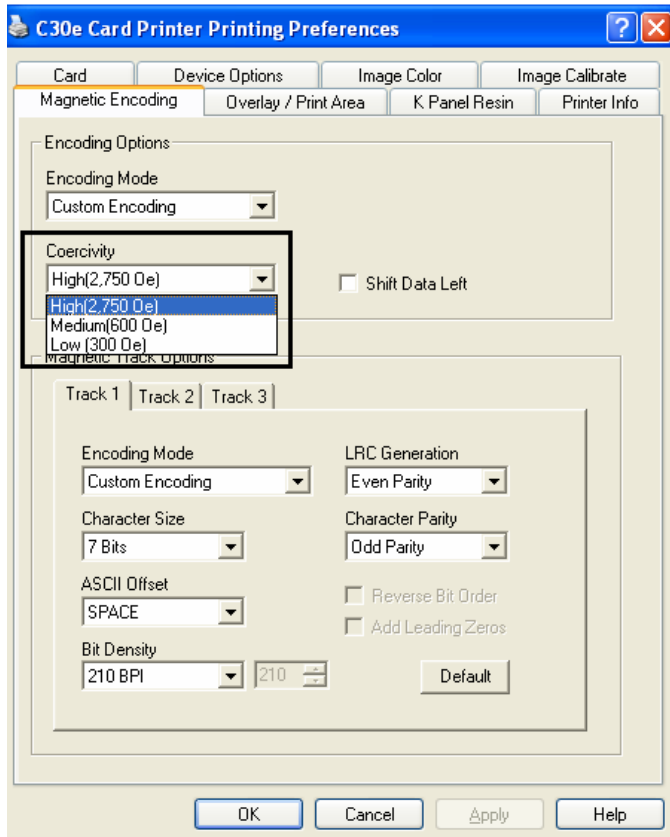

## Reviewing the Shift Data Left Function

Use the **Shift Data Left** option, which applies to all tracks when selected. (**Note:** When this option is unchecked, it is the default.)

Step	Procedure
1	Select this option to shift the recorded magnetic data to the left-hand side of the card's Magnetic Stripe. ( <b>Note:</b> This is useful in situations that require cards to be readable with insert type readers.)

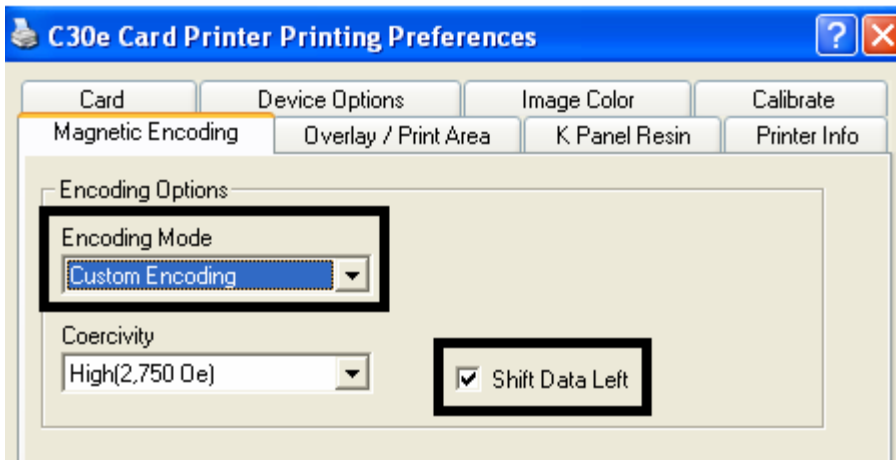

## Reviewing the Magnetic Track Options

Use these options to customize the ISO encoded data format for each of the Magnetic Stripe's three tracks. (**Note:** Click **Default** to reset the defaults for the current Magnetic Track Options tab only.)

Step	Procedure
1	<p>Specify which of the three (3) tracks to customize by selecting one of the three track options.</p> <ul style="list-style-type: none"> <li>• After making the required selection, the Magnetic Track Options box displays the current set of customization options for the selected track.</li> <li>• Remember that each track must be customized independently of the other two.</li> </ul>

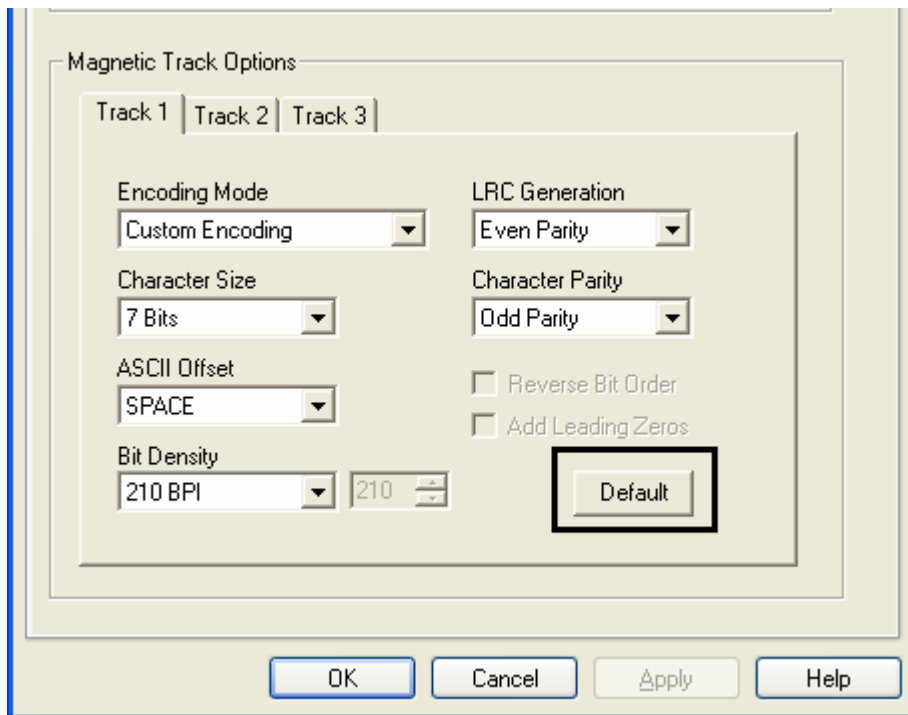

## Using the Magnetic Track Options

Use the **Magnetic Track** options for these purposes:

- Customize the ISO-encoded data format for each of the Magnetic Stripe's three tracks.
- Customize each track independently of the other two.
- Specify which track to customize by selecting one of the three track options.)
- Click **Default** to reset the defaults for the current Magnetic Track Options tab only.

(**Note #1:** After making the required selection, the Magnetic Track options box displays the current set of customization options for the selected track.)

(**Note #2:** For most applications, the default settings for these options do not need to be changed.)

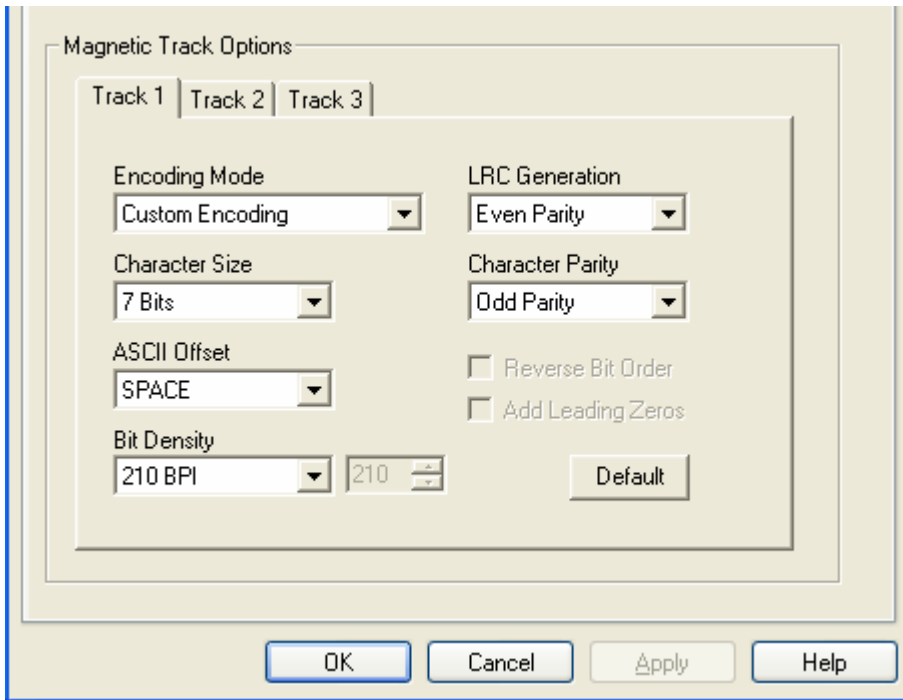

## Using the Character Size buttons

Use this option to customize the Character Data Size (Bits per Character) used to encode the magnetic data on the currently selected track. (**Note:** This character size includes the parity bit (if enabled).)

Step	Procedure
1	<p>Select <b>4 Bits</b> to change the bits per character to 4 BPC. (<b>Note:</b> This is the default for Track 3).</p> <p>Select <b>5 Bits</b> to change the bits per character to 5 BPC. (<b>Note:</b> This is the default for Tracks 2 and 3).</p> <p><b>OR</b></p> <p>Select <b>7 Bits</b> to change the bits per character to 7 BPC. (<b>Note:</b> This is the default for Track 1).</p> <p><b>OR</b></p> <p>Select <b>8 Bits</b> to change the bits per character to 8 BPC.</p>

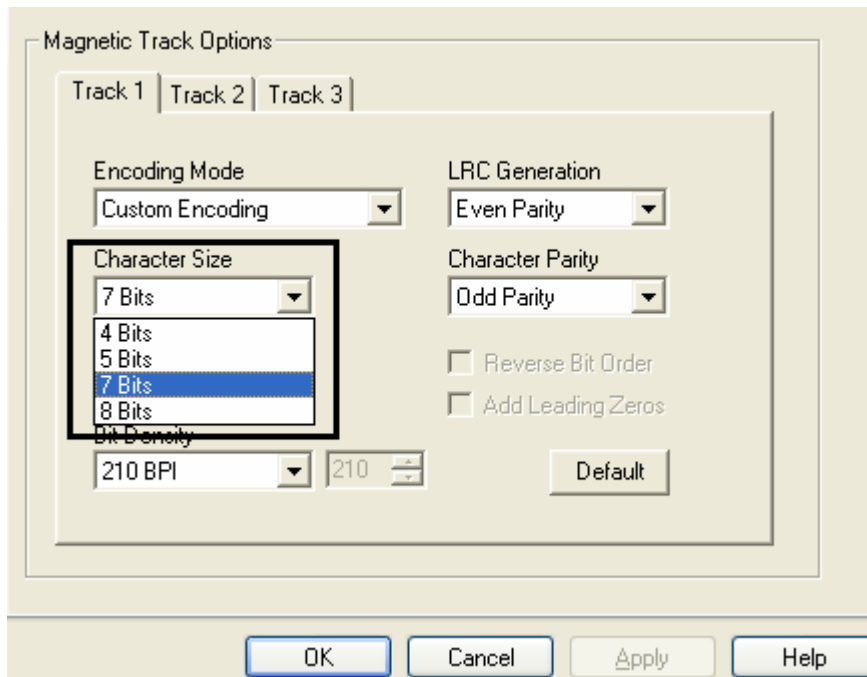

## Using the ASCII Offset dropdown list

Use this option to customize the Character ASCII Offset used to encode the magnetic data on the currently selected track. (**Note:** This character-offset value is subtracted from the ASCII value of each Magnetic Stripe data character prior to encoding on the track.)

Step	Procedure
1	<p>Select <b>NULL</b> to change the ASCII Offset to NULL.</p> <p><b>OR</b></p> <p>Select <b>SPACE</b> to change the ASCII Offset to SPACE. (<b>Note:</b> This is the default for Track 1.)</p> <p><b>OR</b></p> <p>Select <b>ZERO</b> to change the ASCII Offset to ZERO. (<b>Note:</b> This is the default for Tracks 2 and 3.)</p>

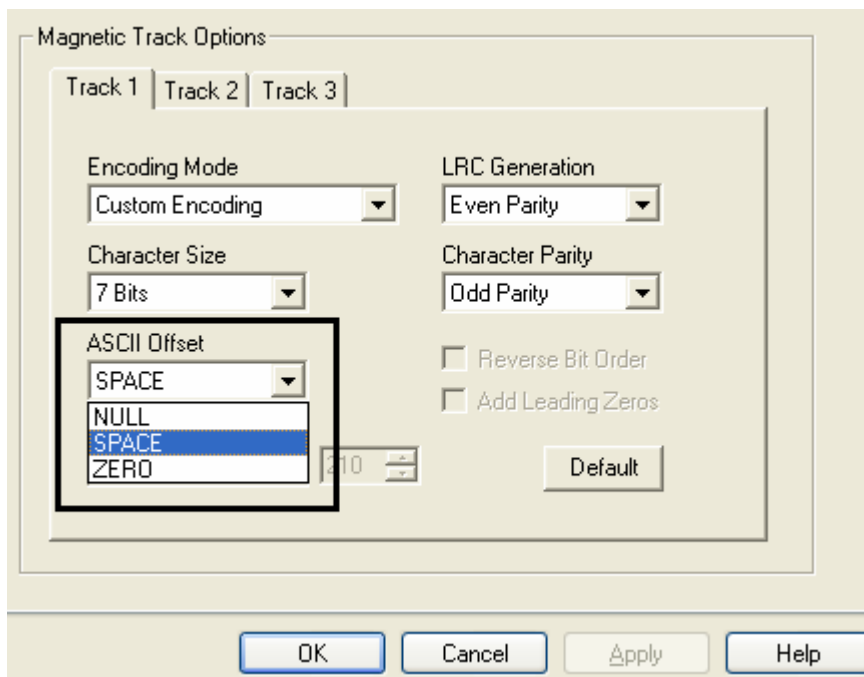

## Using the Bit Density dropdown list

Use this option to customize the Bit Recording Density (Bits per Inch) used to encode the magnetic data on the currently selected track.

The default ISO Standard selections for this option are as follows:

Step	Procedure
1	<p>Select <b>75 BPI</b> to change the bits per inch to 75 BPI. (<b>Note:</b> This is the default for Track 2.)</p> <p><b>OR</b></p> <p>Select <b>128 BPI</b> to change the bits per inch to 128 BPI.</p> <p><b>OR</b></p> <p>Select <b>210 BPI</b> to change the bits per inch to 210 BPI. (<b>Note:</b> This is the default for Tracks 1 and 3.)</p> <p><b>OR</b></p> <p>Select <b>Custom BPI</b>, which enables the custom BPI text box. (<b>Note:</b> The lower limit is 75 and upper limit is 210.)</p>

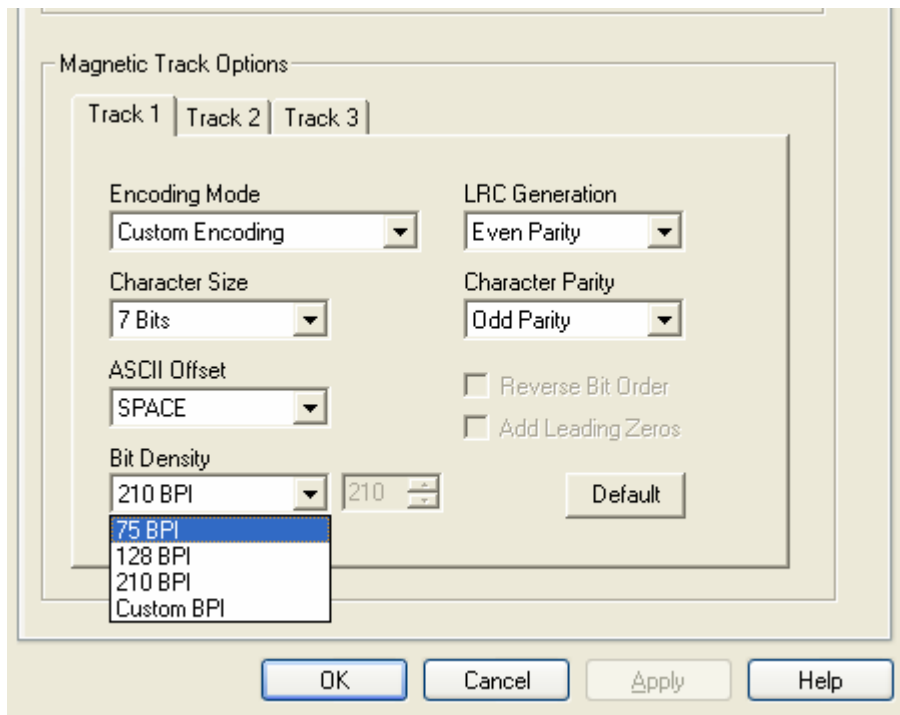

## Using the LRC Generation dropdown list

Use this option to customize the LRC Generation Mode (used to encode the magnetic data on the currently selected track).

Step	Procedure
1	Select <b>No LRC</b> to change the LRC Generation to none. <b>OR</b> Select <b>Even Parity</b> to change the LRC Generation to Even Parity. ( <b>Note:</b> This is the default for all tracks.) <b>OR</b> Select <b>Odd Parity</b> to change the LRC Generation to Odd Parity.

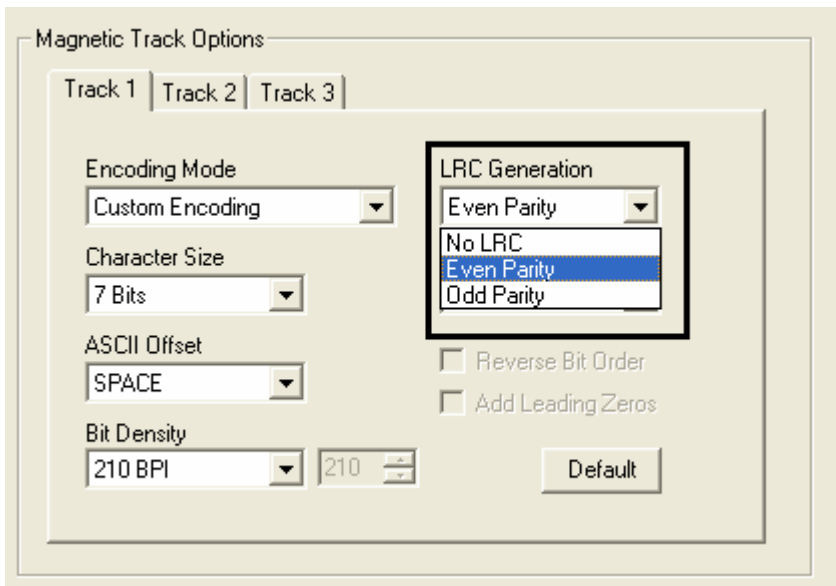



## Using the Character Parity dropdown list

Use this option to customize the Character Parity (used to encode the magnetic data on the currently selected track).

Step	Procedure
1	Select <b>No Parity</b> to change the Character Parity to none. <b>OR</b> Select <b>Even Parity</b> to change the Character Parity to Even Parity. <b>OR</b> Select <b>Odd Parity</b> to change the Character Parity to Odd Parity. ( <b>Note:</b> This is the default for all tracks.)

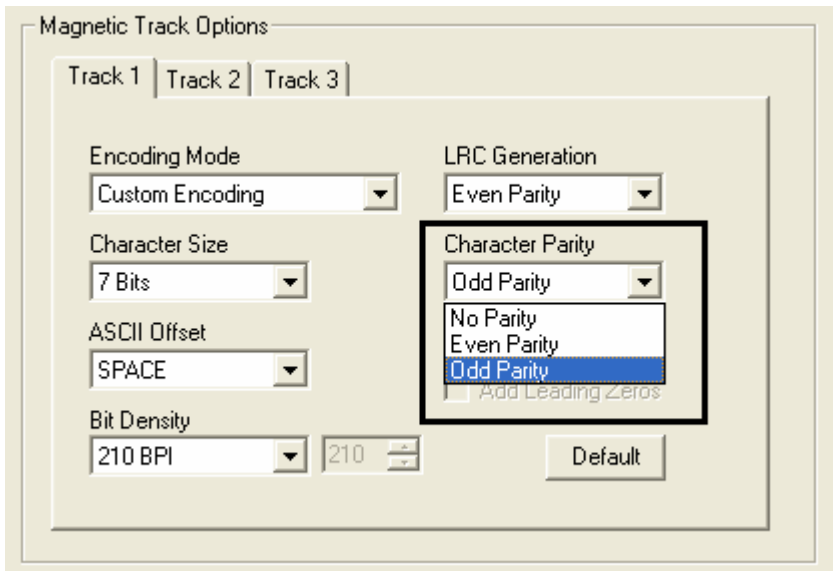

## Reviewing the ISO Track Locations

The magnetic Encoding Module encodes onto tracks in accordance with an ISO 7811-2 Magnetic Stripe. For track locations, review the display below.

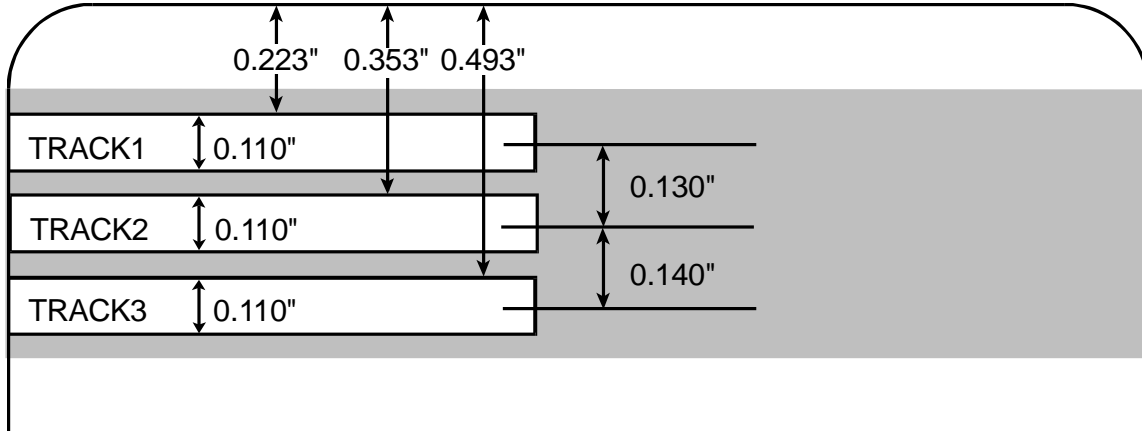

## Sending the Track Information

Magnetic track data is sent in the form of text strings from the application software to the Printer Driver.

- In order for the Printer Driver to differentiate between Magnetic Track data and the rest of the printable objects, specific characters must be added to the magnetic data to be encoded.
- These specify the data that is to be encoded, the tracks to encode and mark the start and stop of the data string.
- In some cases, these specific characters are automatically added to the string of track data by ID software applications.
- In most cases, the user must carefully add these characters to the string of Magnetic Track data. If these characters are not added to the track data, the text intended for the Magnetic Track will appear as printed text on the card.
- To avoid this, track information must be entered as described below.

Step	Procedure
1	<p>When entering track data, the ~ (tilde) character is entered first, followed by the track number (1, 2 or 3) on which the data should encode. This is followed by the data to be encoded.</p> <ul style="list-style-type: none"> <li>• The first character of this data string must be the track's specific Start Sentinel (SS) and the last character must be the specific End Sentinel (ES).</li> <li>• The characters or data in between the SS and ES can include all of the valid characters specific to each track.</li> <li>• The number of these characters, however, is limited by each track's maximum character capacity.</li> <li>• When segmenting track data, the appropriate Field Separator (FS) must be used. The table below shows the SS, ES, FS and the valid characters defined for each track.</li> </ul>

## Reviewing the Sample String

- Track 1: ~1%JULIEANDERSON^1234567890?
- Track 2: ~2;1234567890987654321?
- Track 3: ~3;1234567890987654321?

Track	Start Sentinel	End Sentinel	Field Separator	Valid Characters	Maximum Number of Characters
Track 1	%	?	^	ASCII 32-95 (See the table below.)	78
Track 2	;	?	=	ASCII 48-63 (See the table below.)	39
Track 3	;	?	=	ASCII 48-63 (See the table below.)	106

## Reviewing the ASCII Code and Character Table

ASCII Code	Character	ASCII Code	Character	ASCII Code	Character
32	space	56	8	80	P
33	!	57	9	81	Q
34		58	:	82	R
35	#	59	;	83	S
36	\$	60	<	84	T
37	%	61	=	85	U
38	and	62	>	86	V
39	'	63	?	87	W
40	(	64	@	88	X
41	)	65	A	89	Y
42	*	66	B	90	Z
43	+	67	C	91	[
44	'	68	D	92	\
45	-	69	E	93	]
46	.	70	F	94	^
47	/	71	G	95	_
48	0	72	H		
49	1	73	I		
50	2	74	J		
51	3	75	K		
52	4	76	L		
53	5	77	M		
54	6	78	N		
55	7	79	O		

## Using the Overlay / Print Area tab (DTC400e/C30e/M30e)

Use this option to control where the Overlay (O) Panel and/or the print area appear on a card. (**Note:** This option is helpful if, for example, you would like to omit or block out the overlay or printing around a card's smart chip or Magnetic Stripe.)

By default, this option is set to print and overlay the entire card. To customize the overlay and/or print area, select one of the options listed under "Overlay / Print Area."

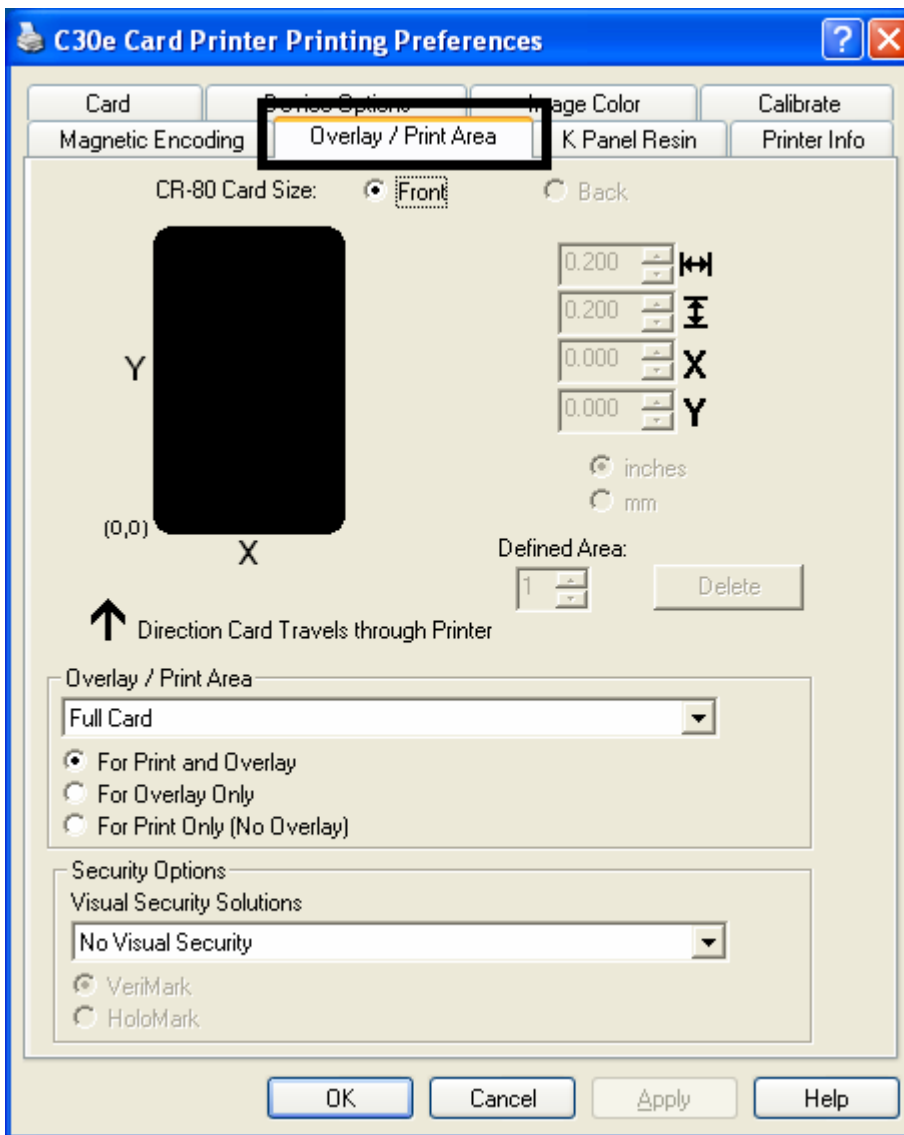

## Enabling the Back options

Step	Procedure
1	Select <b>Print Both Sides</b> under the Device Options tab to enable the <b>Back</b> option under the Overlay / Print Area. ( <b>Note:</b> This same selection applies to the K Panel Resin back option.)

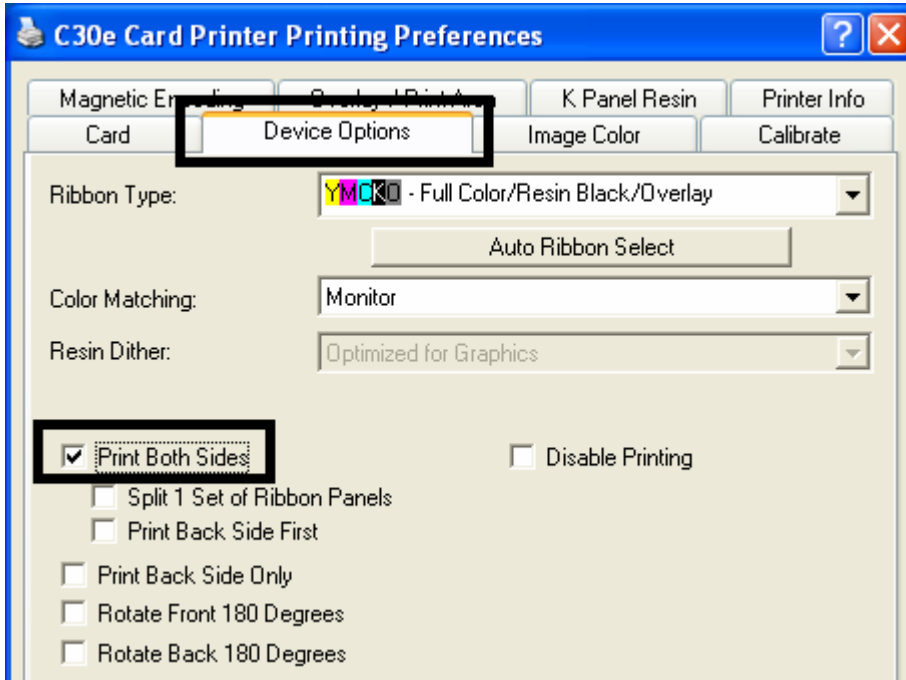

## Using the Front option (Overlay / Print Area)

Step	Procedure
1	Select <b>Front</b> to view the Overlay/Print Area options for the front of the card.

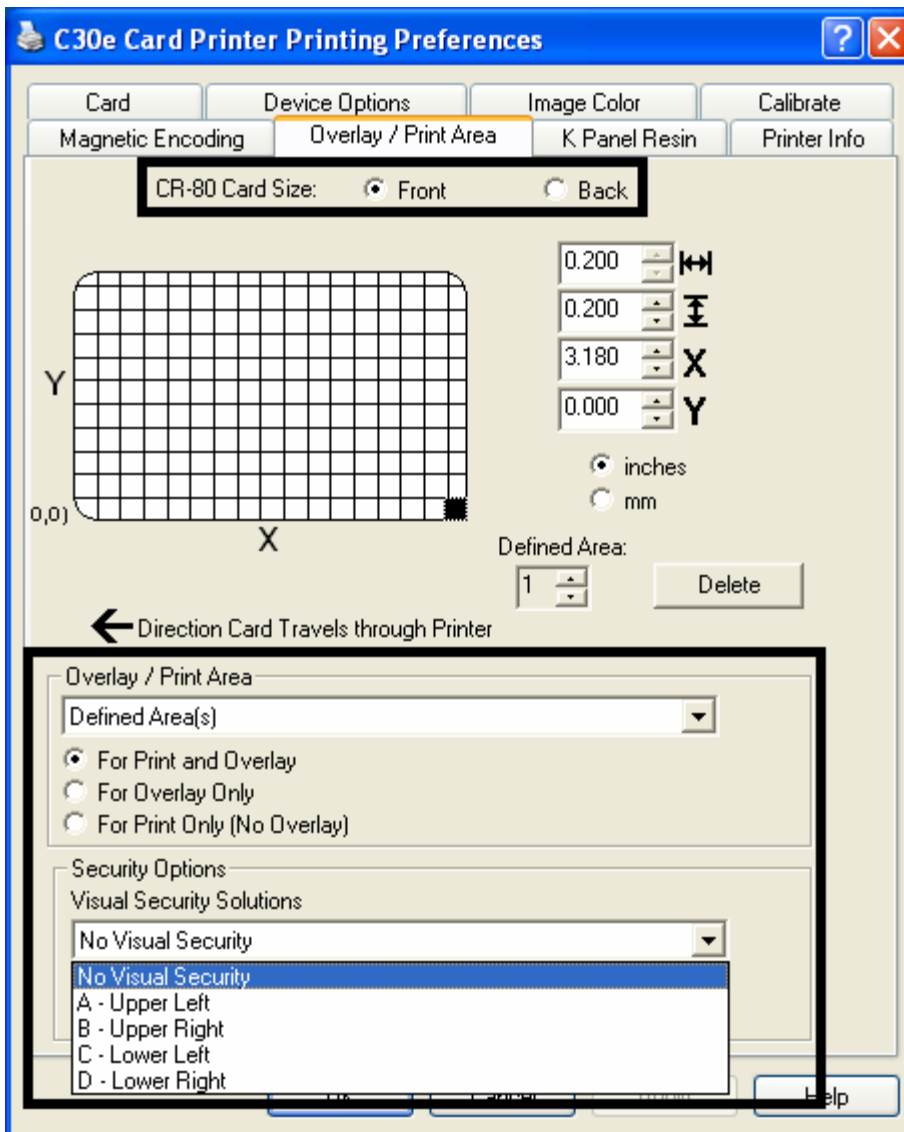



## Using the Back option (Overlay / Print Area)

Step	Procedure
1	Select <b>Back</b> to view the Overlay/Print area options for the back of the card. ( <b>Note:</b> The <b>Back</b> option is only available if Print Both Sides is selected.)

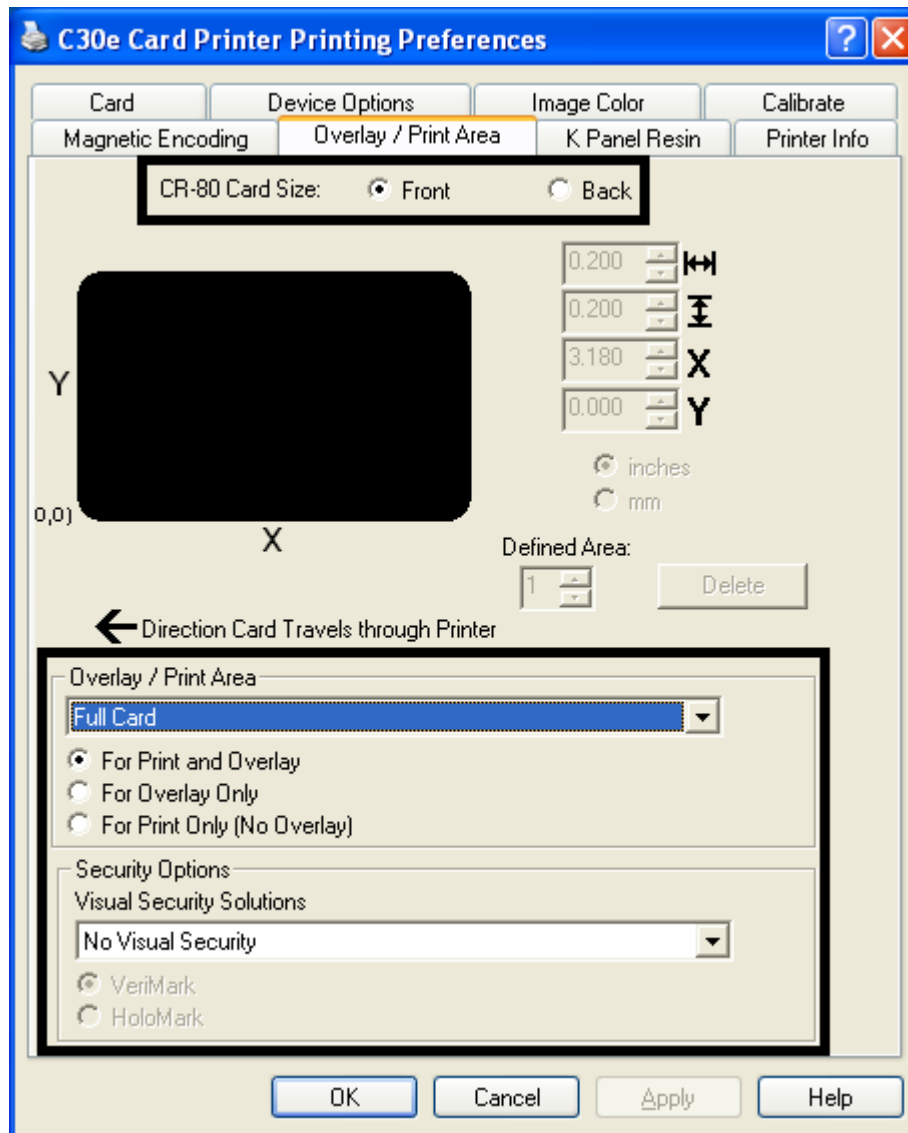

## Using the Overlay / Print Area dropdown menu

Step	Procedure
1	<p>Select <b>Full Card</b> for the Printer to overlay and/or print the entire card.</p> <p><b>OR</b></p> <p>Select <b>Defined Area(s)</b> for the Printer to overlay and/or print only in the selected and defined area or areas.</p> <p><b>OR</b></p> <p>Select <b>Undefined Area(s)</b> for the Printer to overlay and/or print only in the space outside the selected and defined area.</p> <p><b>OR</b></p> <p>Select <b>Omit Smart Chip Area</b> for the Printer to overlay and/or print only in the space outside the standard location of a smart chip.</p> <p><b>OR</b></p> <p>Select <b>Omit Magnetic Stripe Area</b> for the Printer to overlay and/or print only in the space outside the standard location of an ISO Magnetic Stripe.</p> <p><b>OR</b></p> <p>Select <b>Omit Signature Area</b> for the Printer to overlay and/or print only in the space outside the standard location of a signature panel.</p> <p><b>(Note:</b> In the card grid, black indicates the area in which the overlay and/or printing will be applied.)</p>

See the previous page for the related procedure.

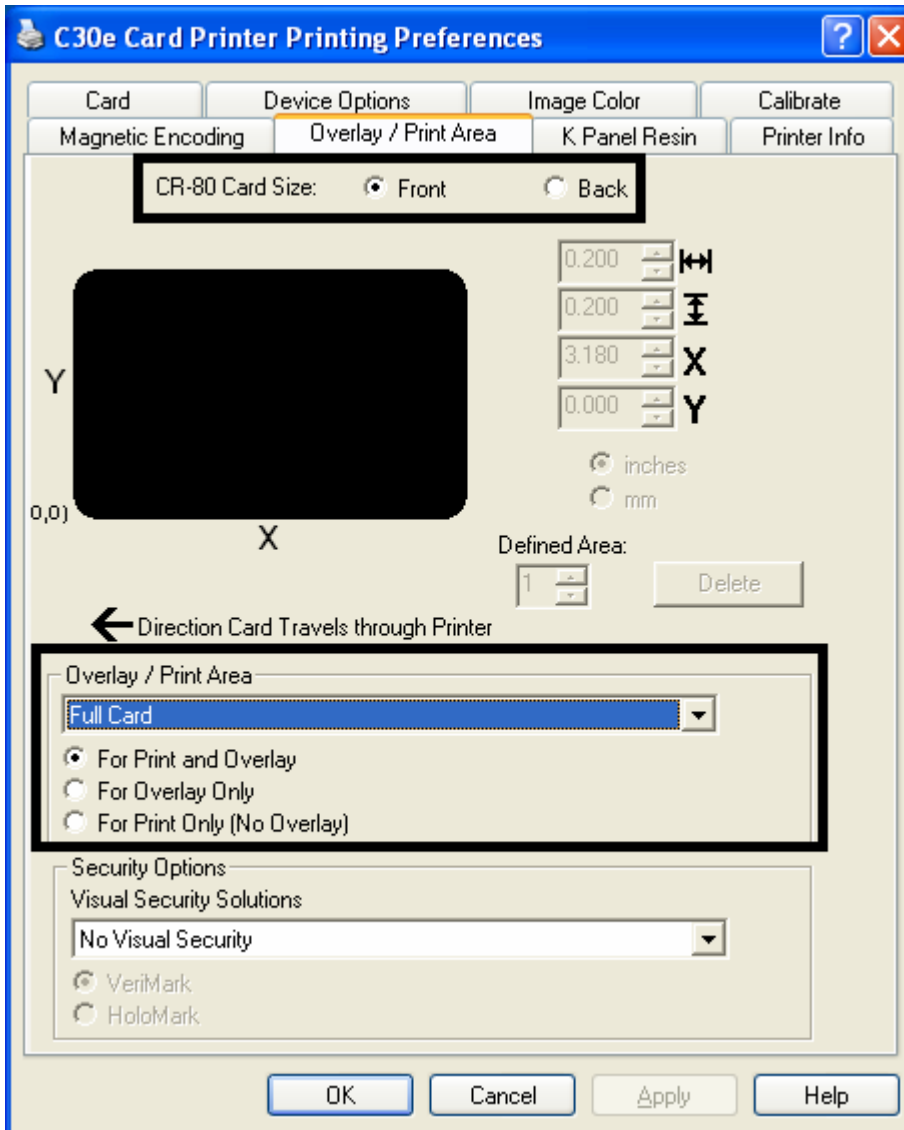

## Using the Overlay / Print Area

Use these **Overlay / Print Area** options to control both the print and overlay together or control each individually. (**Note:** Determine whether to use the Frontside option (via the **Front** radio button) or the Backside option (via the **Back** radio button).)

Step	Procedure
1	<p>Select <b>For Print and Overlay</b> for the defined area to apply to both the printing and overlay process.</p> <p><b>OR</b></p> <p>Select <b>For Overlay Only</b> for the defined area to apply only to the overlay process. (<b>Note:</b> In this mode, printing will still be allowed over the entire card and only the overlay will be affected.)</p> <p><b>OR</b></p> <p>Select <b>For Print Only (No Overlay)</b> for the defined area to apply only to the print process. (<b>Important:</b> In this mode, the overlay is completely disabled so it will not be applied.)</p> <p> <b>Caution:</b> An overlay or an overlamine must protect dye-sublimation printing or it will quickly begin to wear or fade.</p>

See the previous page for the related procedure.

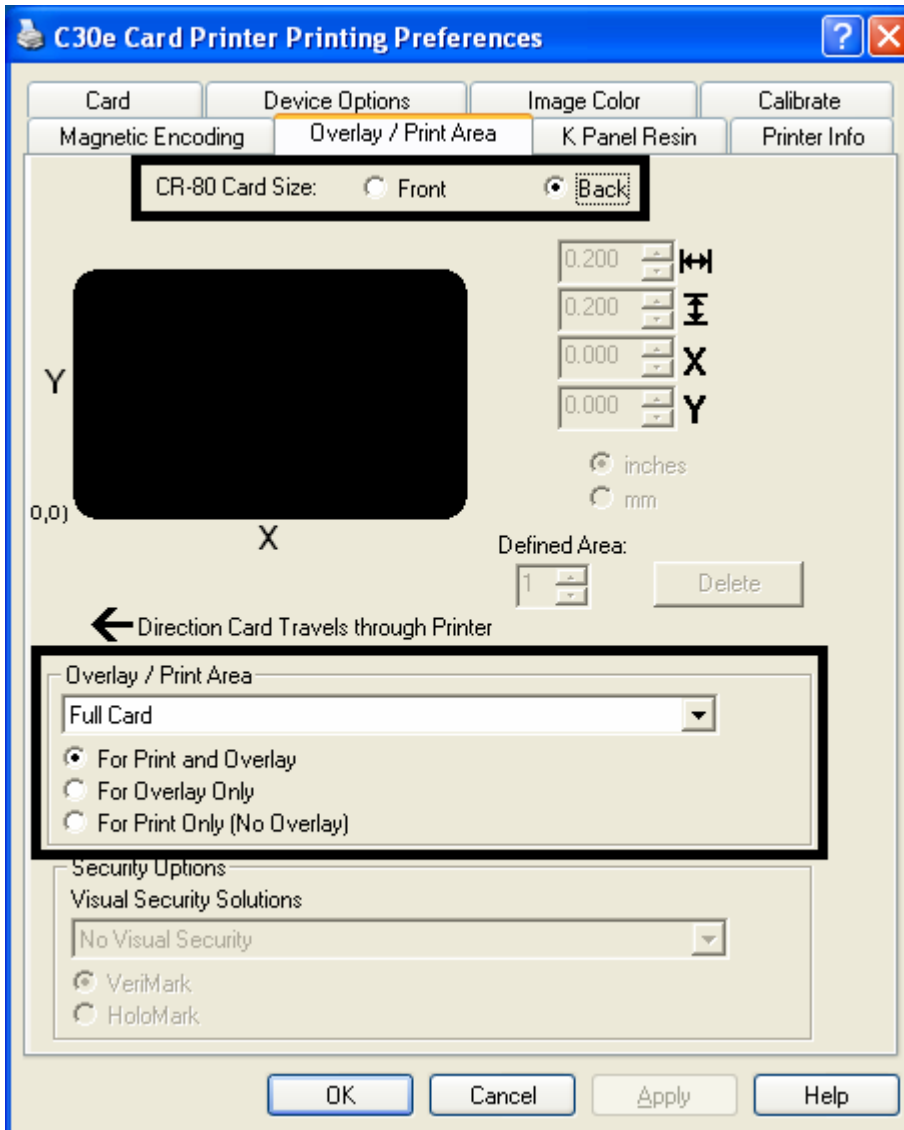

## Using the Defined Area Option

Step	Procedure
1	<p>a. Determine whether to use the Front option (via the <b>Front</b> radio button) or the Back option (via the <b>Back</b> radio button).</p> <p>b. Select the <b>Defined Area(s)</b> option to activate the card grid in the upper half of the window. It is through this card grid that up to five (5) Defined Areas can be assigned.</p>

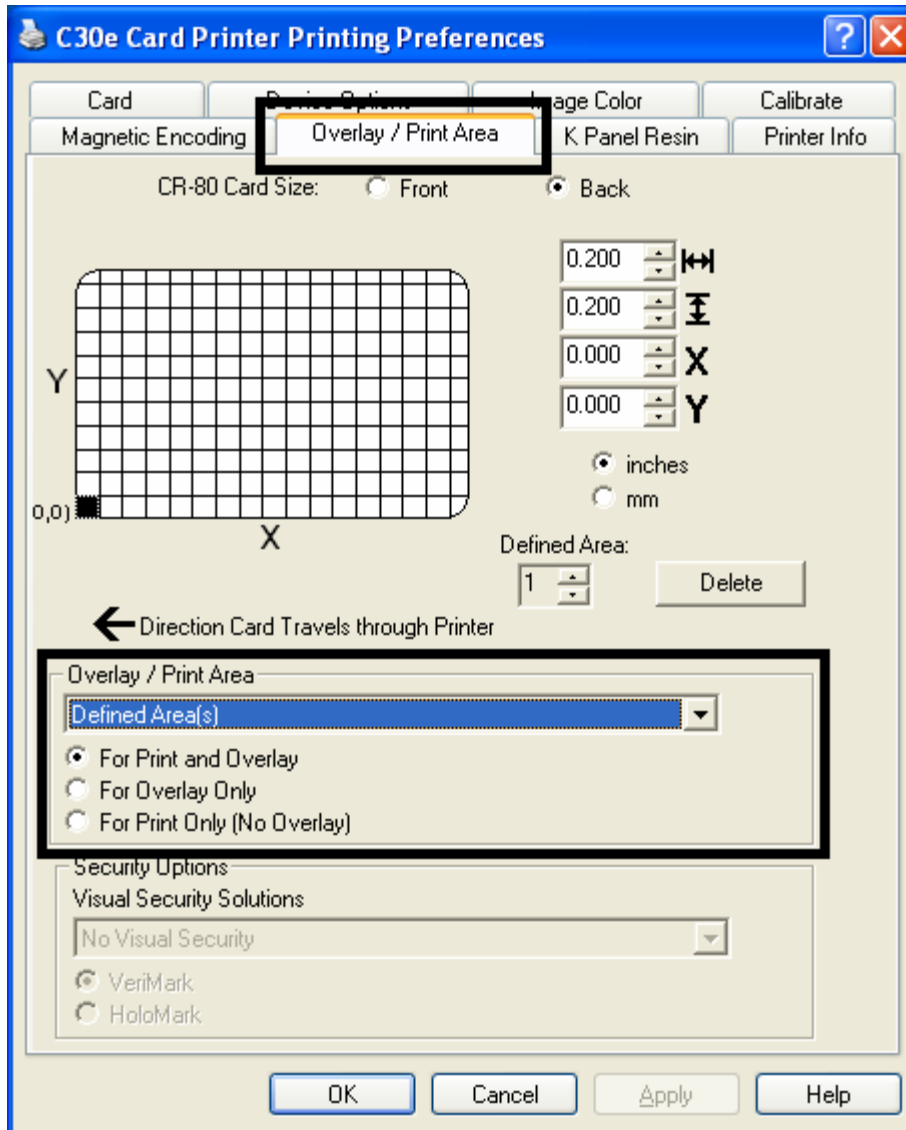

2	<p>When the card grid is first activated, a small black square will appear at its default size of .2" x .2" / 5mm x 5mm and at its default location in the lower left-hand corner (0, 0). This square represents the first defined area.</p>
---	--

	<ul style="list-style-type: none"> <li>• Determine the area of the card needed to define for a signature panel with a different size and location than the Driver's standard <b>Omit Signature Area</b> setting. (<b>Note:</b> This area is indicated by the dashed outline.)</li> <li>• Determine the area size by actually printing a card and looking at it in the same orientation as when it exits the Printer.</li> </ul>
3	<p>Measure the total size of the desired area and enter those dimensions into the dimension boxes. (<b>Note:</b> The minimum size an area is .2" x .2" / 5mm x 5mm.)</p>

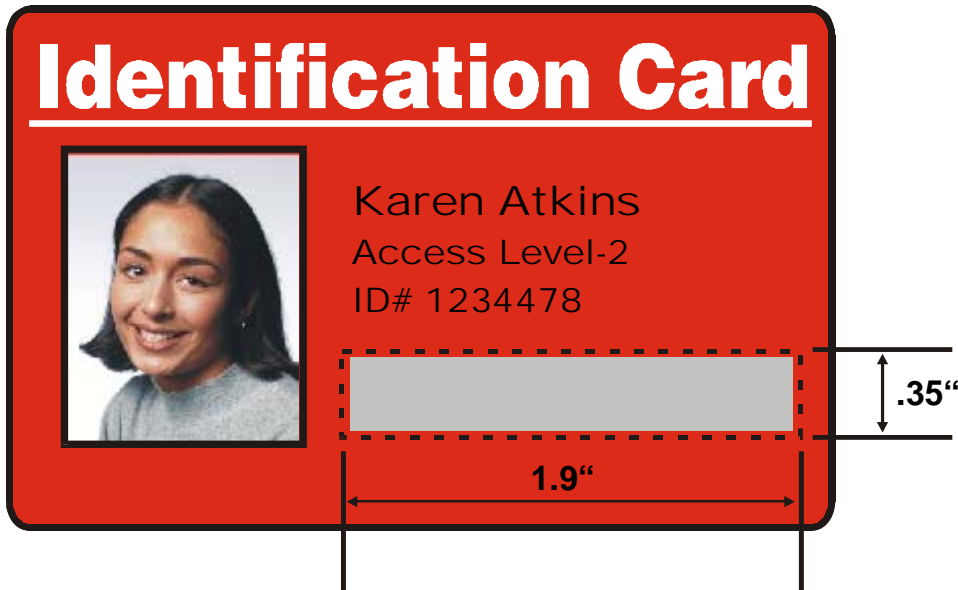

4	<p>Measure from the lower left corner of the card up and over to the lower left corner of for the defined area to begin and enter these values into the X and Y boxes. (<b>Note:</b> The card grid lines are spaced at .2 inch / 5mm intervals.)</p>
---	--

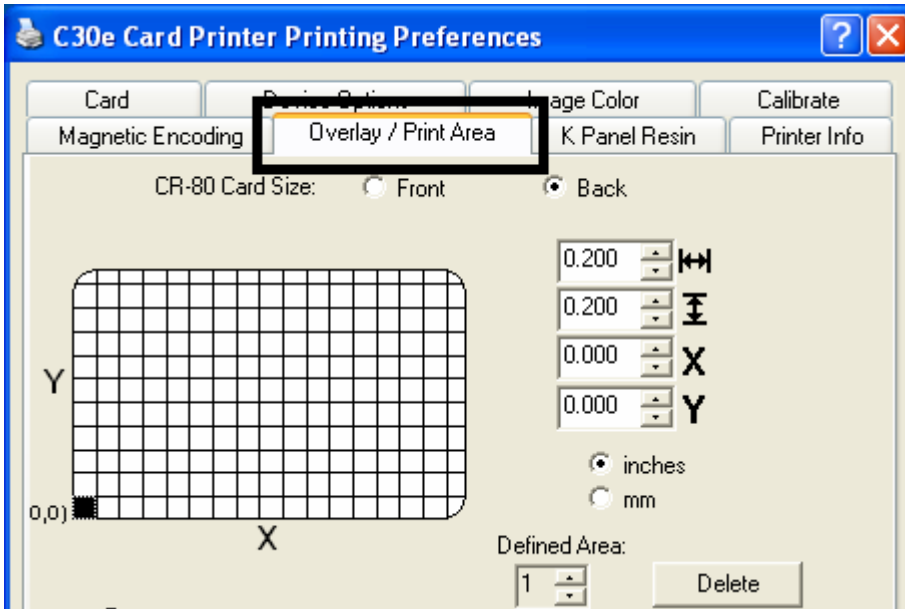

- |   |  |
|---|--|
| 5 | <ol style="list-style-type: none"> <li>a. Print the card design and observe how the image is oriented on the card as it ejects from the Printer. (<b>Note:</b> The location of a defined area is based on the card orientation as it exits the Printer.)</li> <li>b. Measure the defined area location based on the printed card. (<b>Note:</b> If selecting the <b>Rotate Front 180 Degrees</b> option, the image will appear upside down as it exits the Printer.)</li> <li>c. Position the defined area opposite to the measurement of the onscreen card design (which will appear right side up).</li> </ol> |
|---|--|



- |   |   |
|---|---|
| 6 | <ul style="list-style-type: none"> <li>• Determine whether to use the <b>Front</b> option (via the <b>Front</b> radio button) or</li> </ul> |
|---|---|



- the Back option (via the **Back** radio button).
- Use the Defined Area arrows to navigate back and forth from area to area in the Front or Backside area. (**Note:** The active area will always be highlighted with a dotted outline.)
  - Define another area by clicking on the Defined Area UP arrow.
    - Another .2" x .2" / 5mm x 5mm area will appear in the lower left-hand corner. (**Note:** This is the location in which all newly defined areas will first appear.)
    - New areas are always created in the same position with the same size so it is recommended to move or resize them as they are created.
    - All five defined or undefined areas can be added without moving the previous one to another location. The up arrow on the Defined Area control can be activated five times in a row and there are five areas added. After five areas are added there appears to be only one until you move each one to a different location.
  - Delete an area by using the Defined Area arrows to select the area and click **Delete**. (**Note:** If all areas are deleted, the K Panel Resin options will automatically be deselected.)

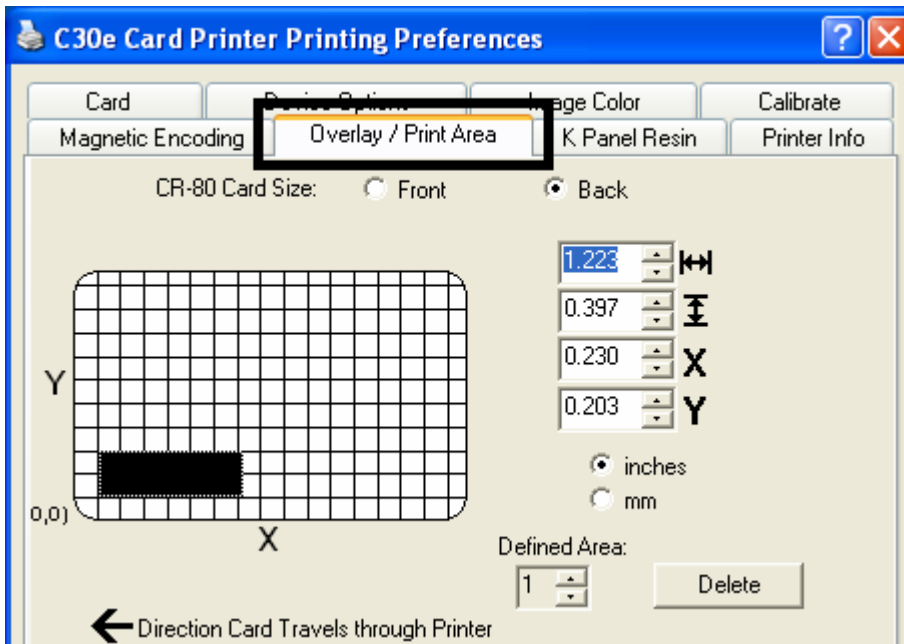

## Using Security Options (Visual Security Solutions) (Front option only)

The Visual Security Solutions dropdown menu list will be used to enable and select which type of visual security will be used. The Visual Security dropdown list will be selectable only on the Front side (see below). Visual Security is not an option for the back side.

The following actions will occur when one of the Visual Security locations is selected.

- The Overlay / Print Area will be disabled.
- The Security Options become selectable.

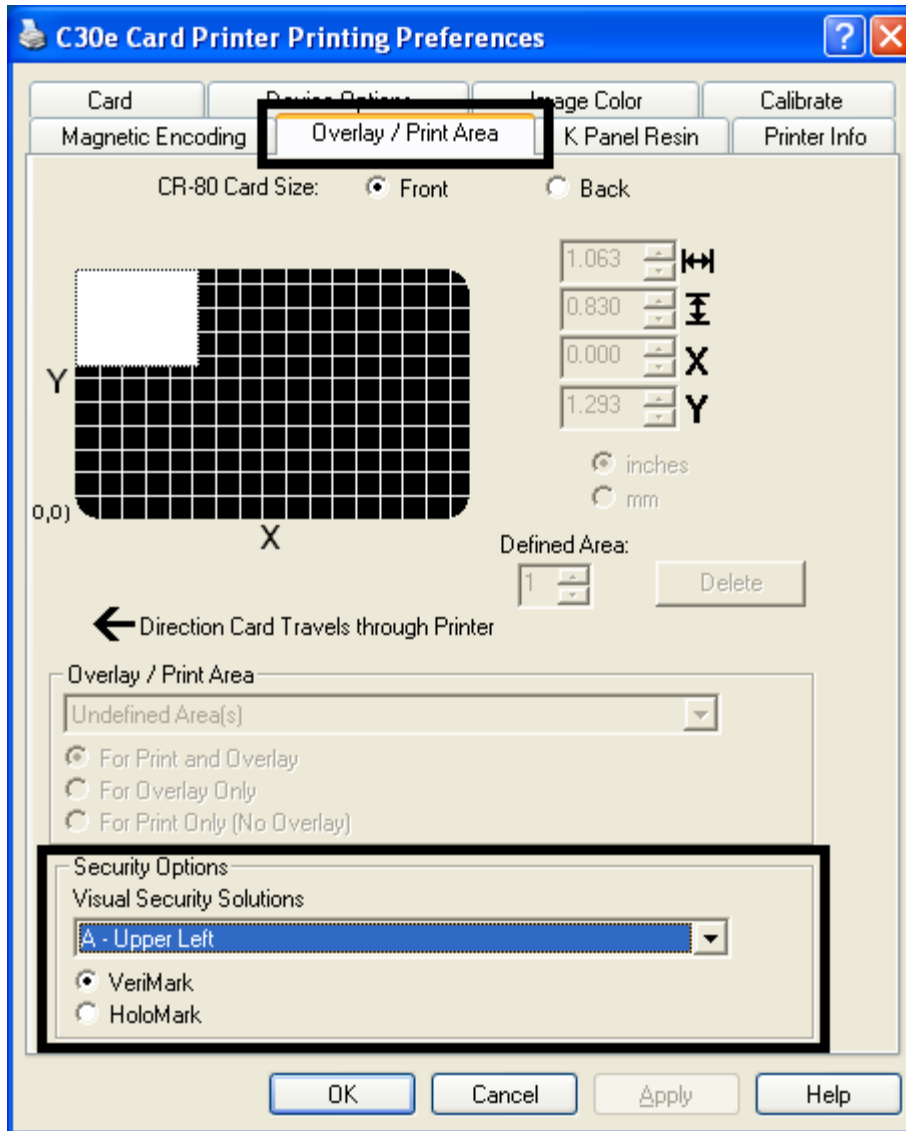

### Selecting Orientation - Landscape under Card tab

Step	Procedure
1	Select <b>Landscape</b> (below) under Orientation under the Card Size tab to use the Visual Security Solutions (A to D), as shown in this window.

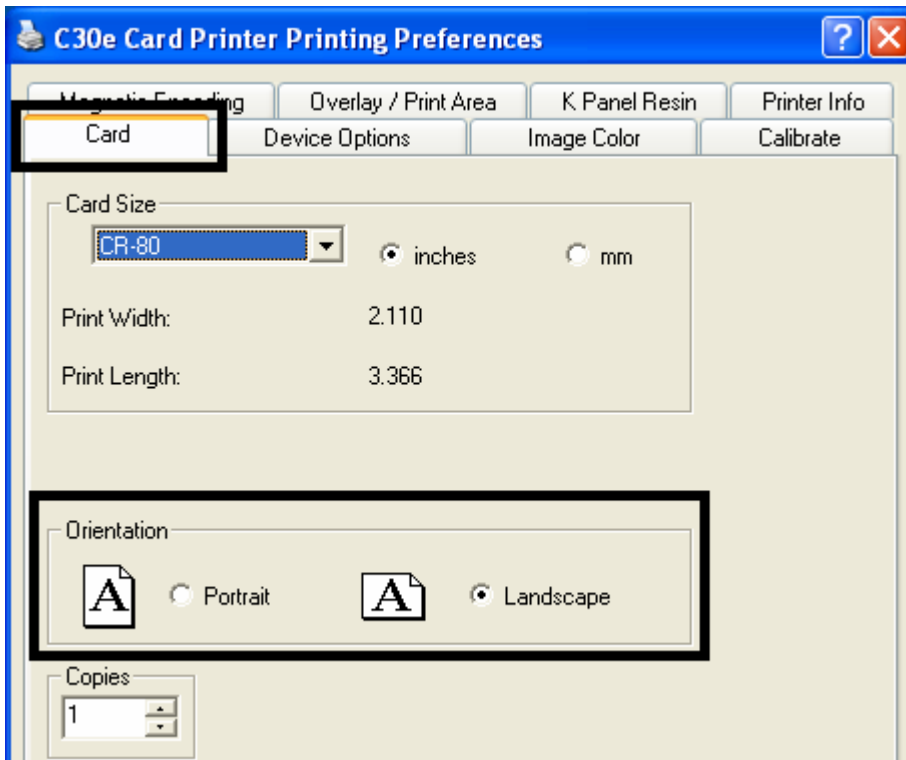

### Selecting the Visual Security Solutions dropdown menu (A to D)

Step	Procedure
1	Click the Visual Security Solutions dropdown menu (below) under the Landscape - Orientation (see above) to use the options shown in this display.

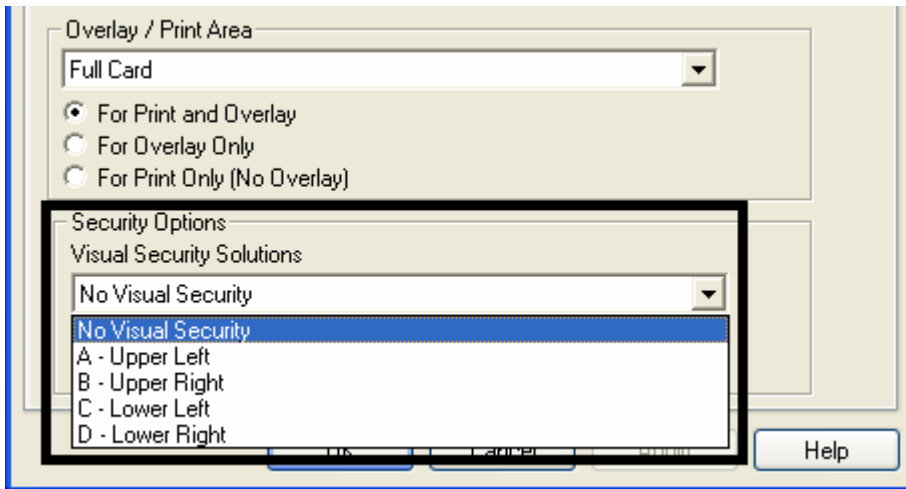

## Selecting Orientation - Portrait under Card tab

Step	Procedure
1	Select <b>Portrait</b> on the Card Size tab to use the Visual Security Solutions (E to H), as shown in this window.

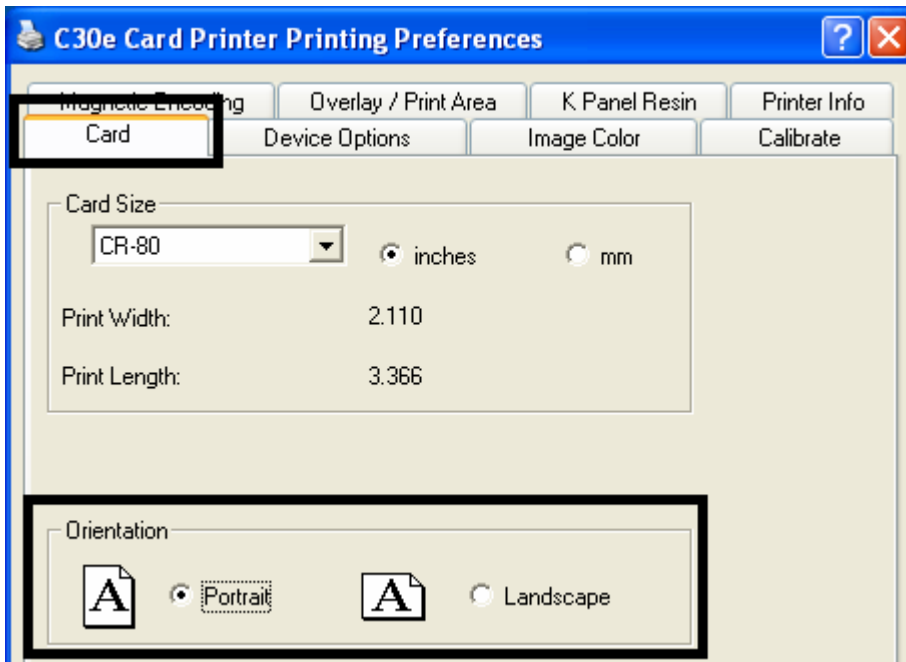

## Selecting the Visual Security Solutions dropdown menu (E to H)

Step	Procedure
1	Click the Visual Security Solutions dropdown menu under the Portrait - Orientation (see above) to use the options shown below.

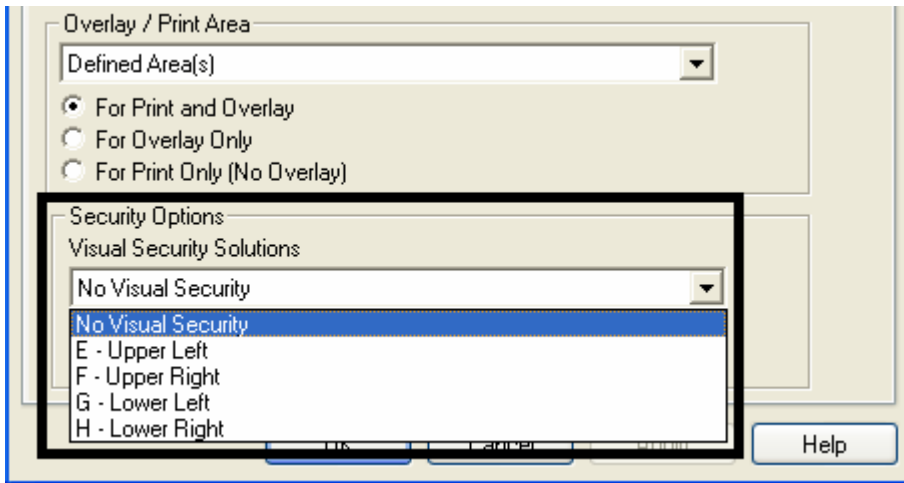

### Selecting the VeriMark radio button (Frontside option only)

Step	Procedure
1	Click either <b>VeriMark</b> or <b>HoloMark</b> as shown below. The foil options are used to control the size of the exclusion area. ( <b>Note:</b> When VeriMark is selected a rectangle-sized area is excluded, HoloMark uses a square sized area.)
2	Click <b>VeriMark</b> (below) for the rectangle-sized area.

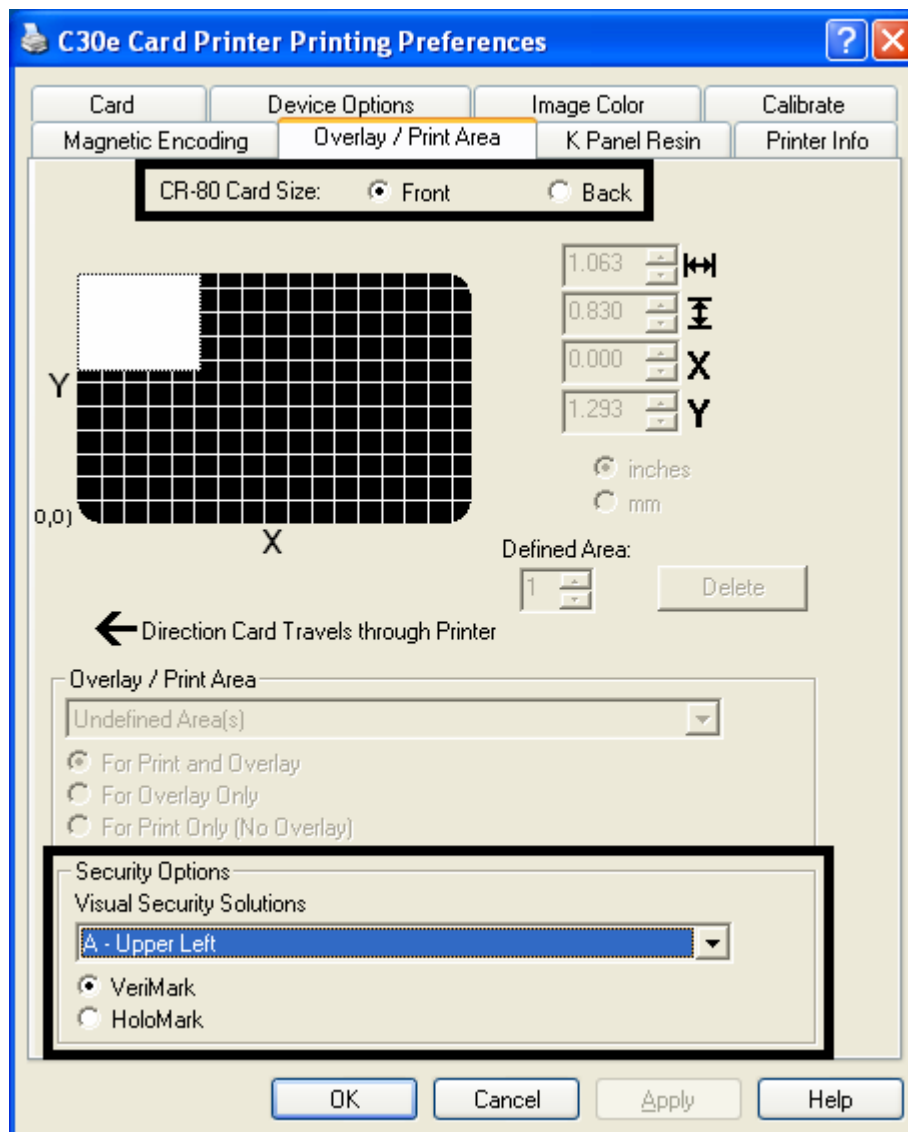

### Selecting HoloMark (Front option only)

Step	Procedure
1	Click <b>HoloMark</b> (below) for the squared-area size.

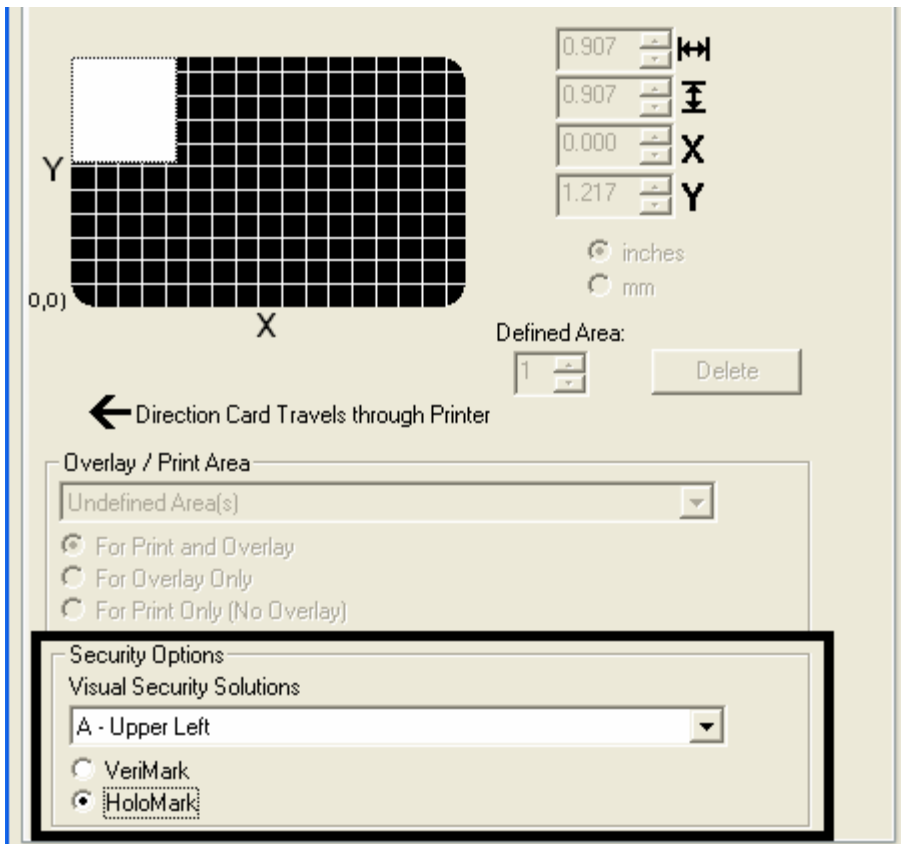



## Reviewing the Custom VeriMark Card (Custom Graphic in a 2D foil)

The custom VeriMark image is stamped on blank, standard-sized cards. You can select one of eight positions (A to H), as shown in the Portrait and Landscape samples below.

Sample 1: VeriMark Card (Landscape - Orientation) - 4 positions (below)

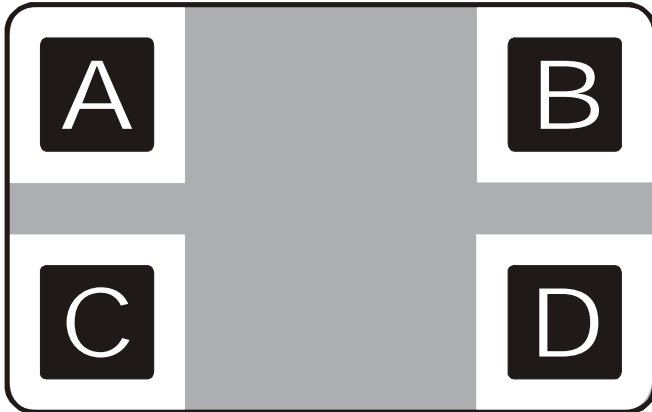

Sample 2: VeriMark Card (Portrait - Orientation) - 4 positions (below)

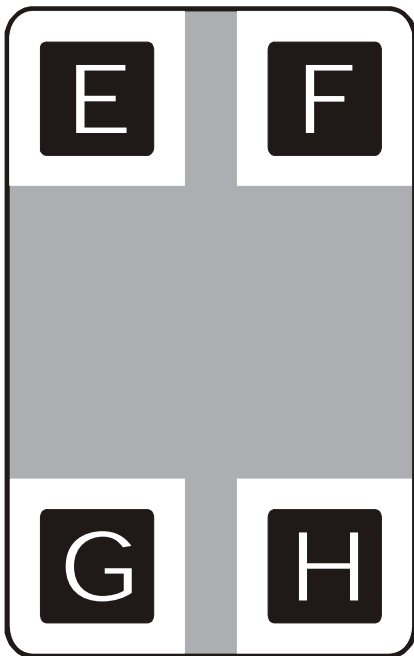

## Reviewing the Custom HoloMark Card (Custom Graphic in a 2D foil)

The custom HoloMark image is stamped on blank, standard-sized cards. You can select one of eight positions (A to H), as shown in the Portrait and Landscape samples below.

Sample 1: HoloMark Card (Landscape - Orientation) - 4 positions (below)

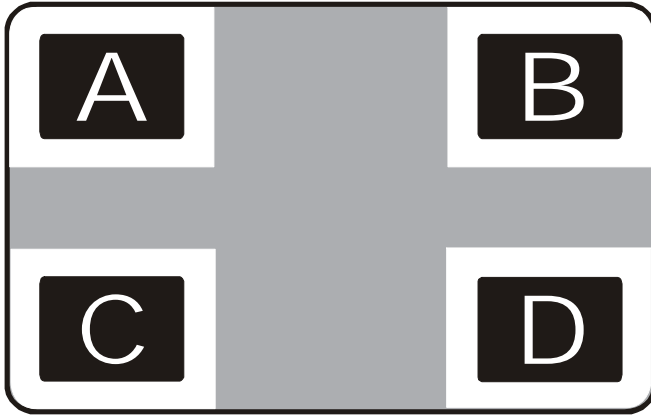

Sample 2: HoloMark Card (Portrait - Orientation) - 4 positions (below)

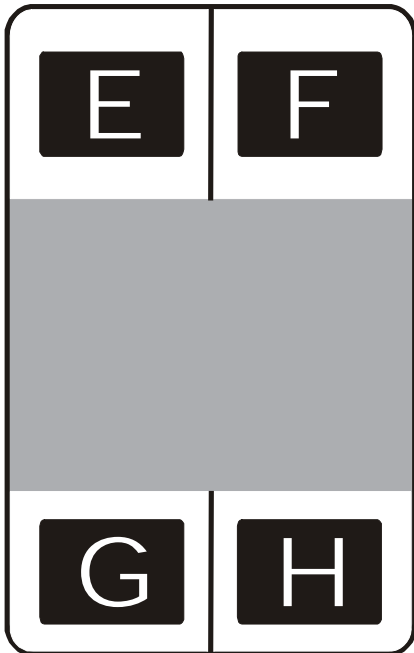

## Using the K Panel Resin tab (DTC400e/C30e/M30e)

Select the **K Panel Resin** option to control where the resin black (K) panel of a full-color Ribbon is printed.

- If printing with a resin-only Ribbon type all K Panel Resin options will be grayed out.
- Resin black text is desirable due to its sharp, saturated black coloring and resin black bar codes are often required by Ultra Violet barcode readers to ensure readability when scanned.)

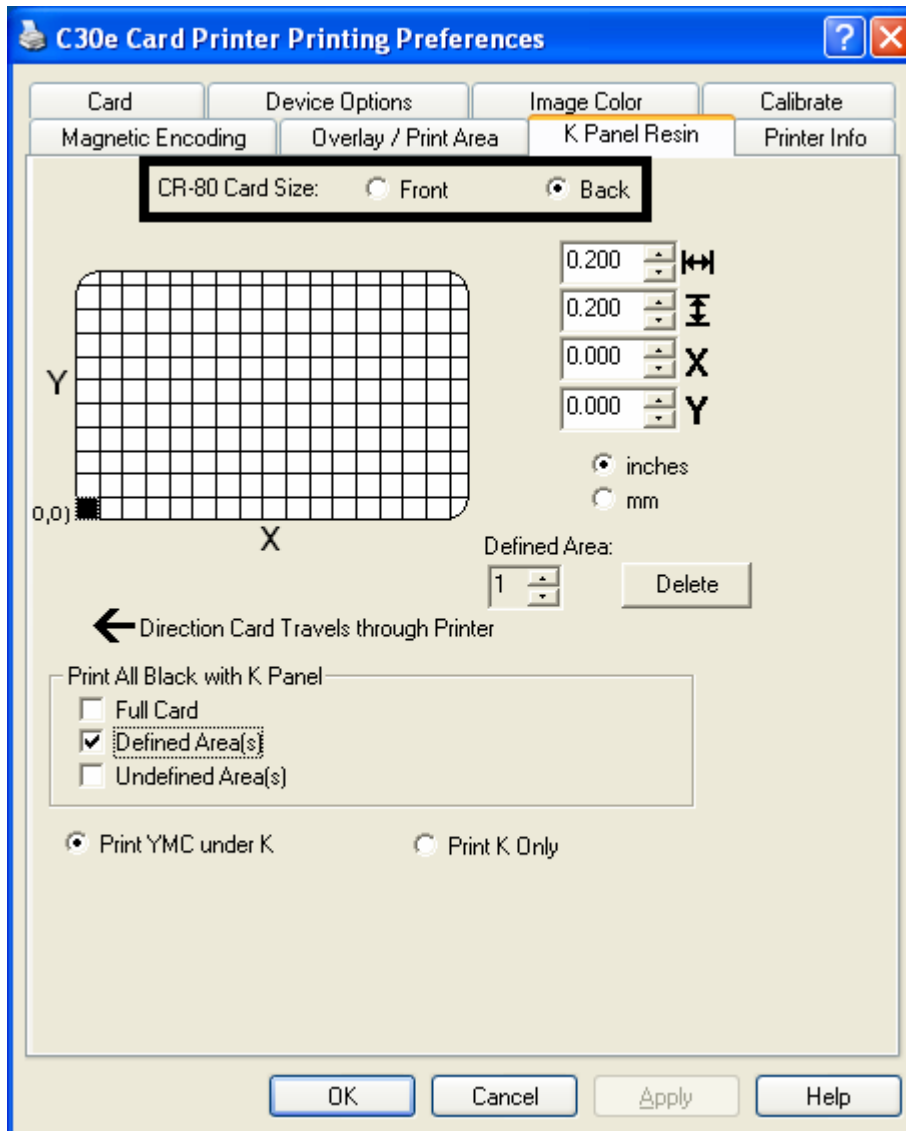

## Enabling the Frontside and Backside options

Step	Procedure
1	Select <b>Print Both Sides</b> under the Device Options tab to enable the Backside option under the K Panel Resin tab. ( <b>Note:</b> This same selection applies to the K Panel Resin backside option.)

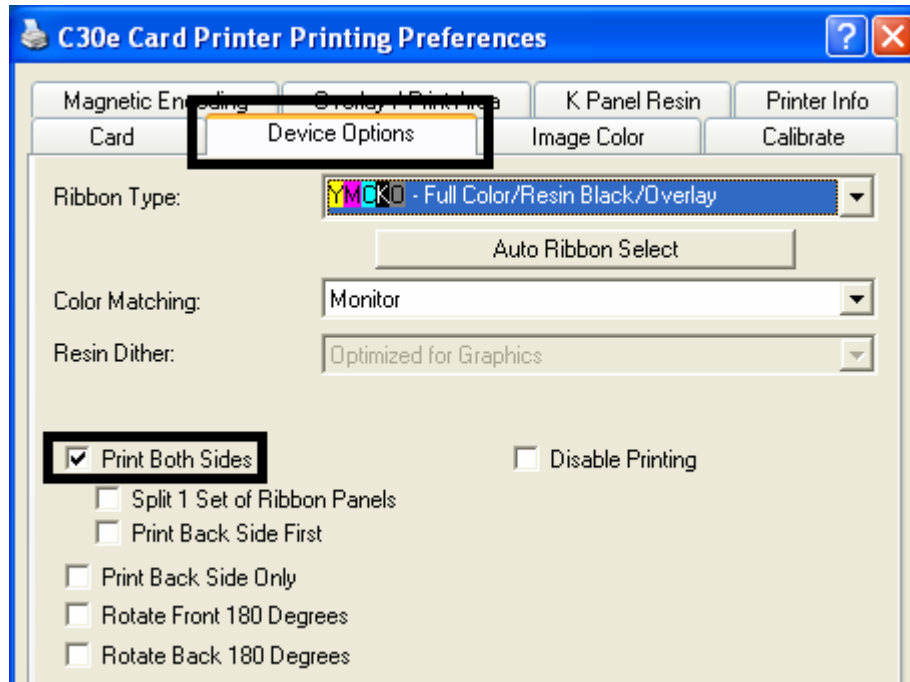

### Enabling the Frontside option (K Panel Resin)

Step	Procedure
1	Select <b>Front</b> to view the K Panel options for the front of the card.

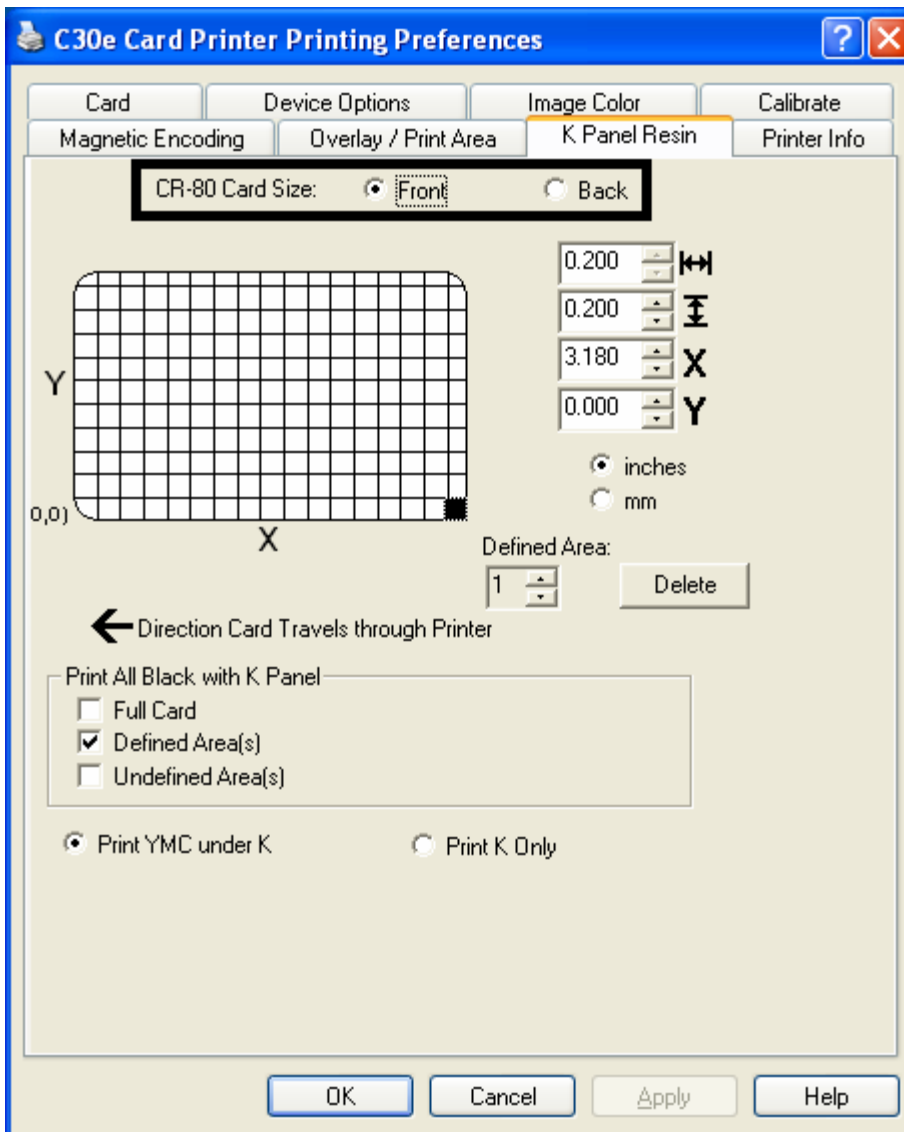

## Enabling the Backside option (K Panel Resin)

Step	Procedure
1	Select <b>Back</b> to view the K Panel Resin options for the back of the card.

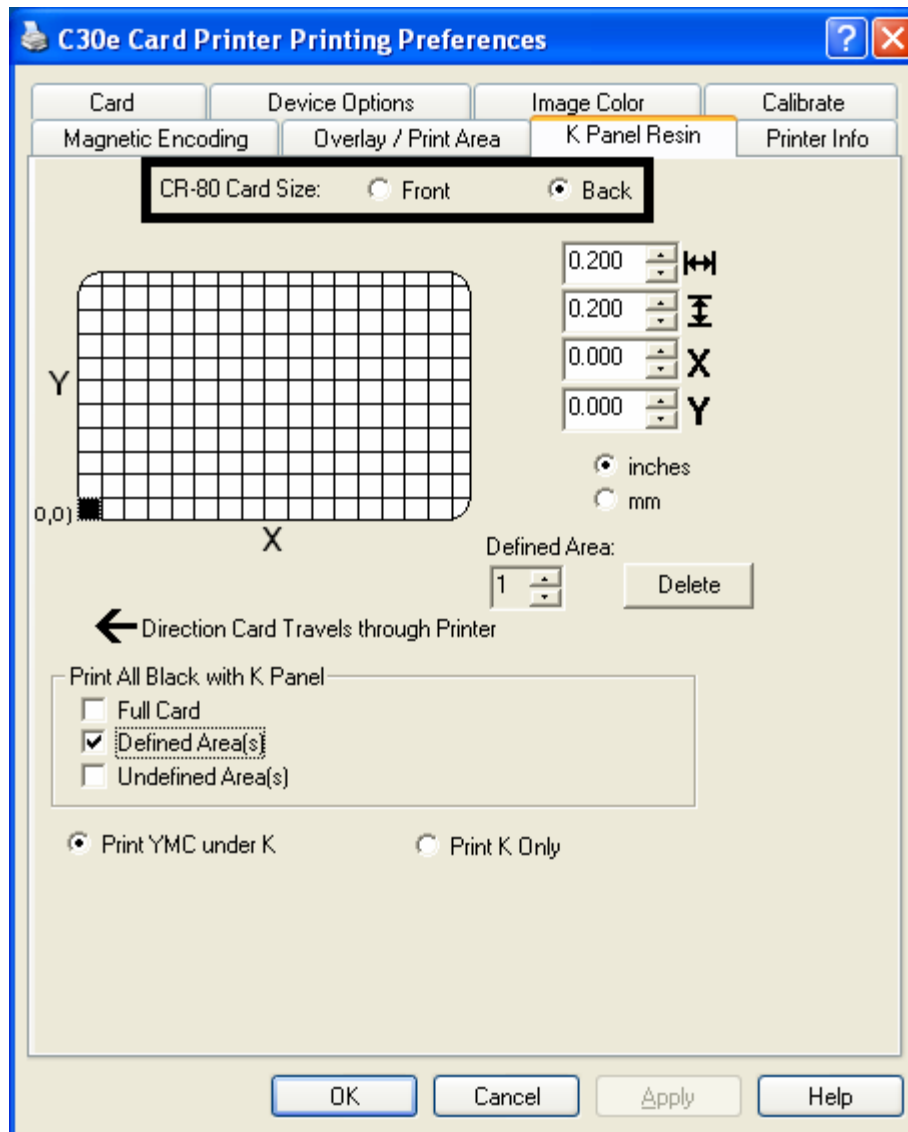

## Selecting from the Print All Black with K Panel options (Front and Back options)

Select one of the three options listed under **Print All Black with K Panel** if the black text or bar codes are not TrueType fonts and/or are not printing with the resin black panel. **(Note:** The Printer Driver will print areas of the image where it finds black coloring with the print Ribbon's resin black (K) panel as specified by each of the following options.

Step	Procedure
1	When none of the options within this window are selected, the Printer Driver will automatically print all TrueType black text and bar codes only with the Resin Black (K) Panel of the print Ribbon.

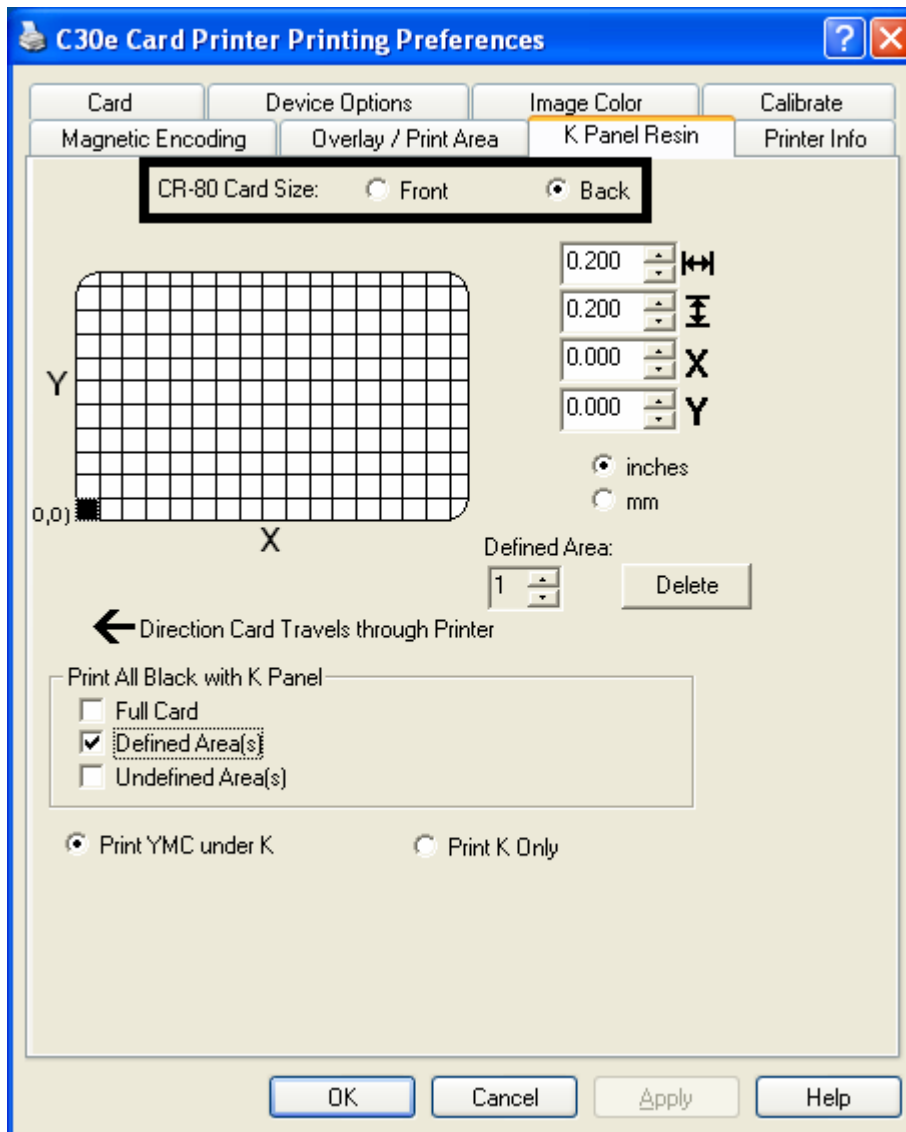

## Selecting the Full Card option (Front and Back options)

Step	Procedure
1	Select <b>Full Card</b> for the Printer Driver to print the resin black (K) panel for all black found within all areas of the image.

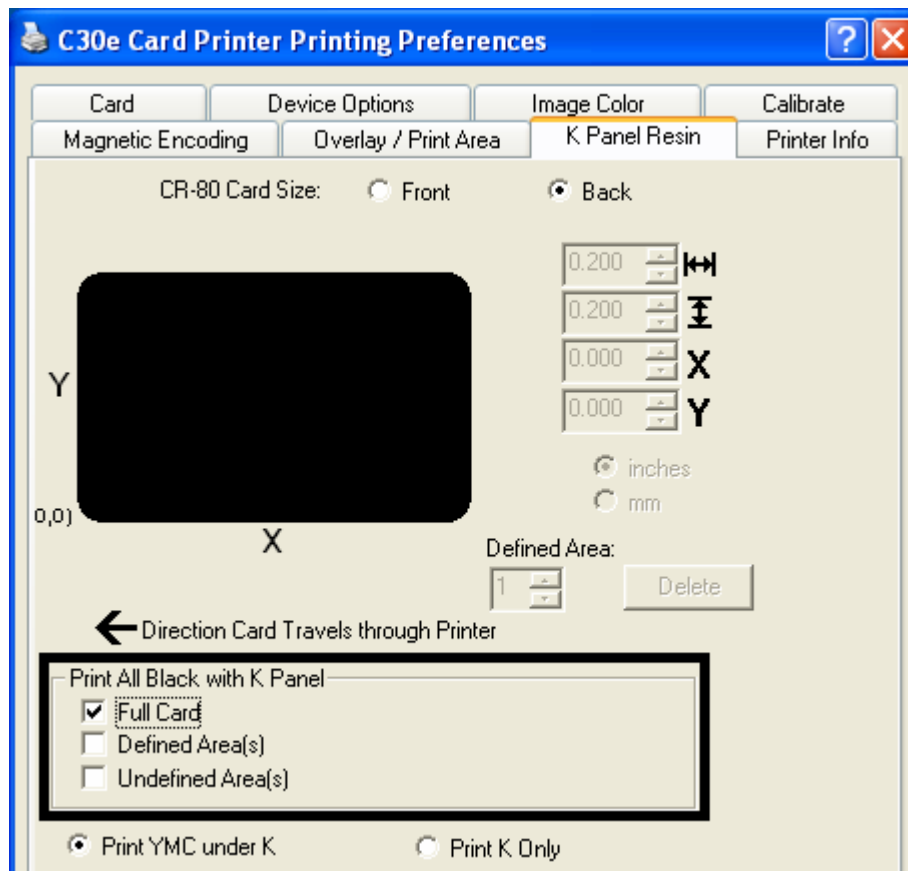



## Selecting the Defined Area(s) option (Front and Back options)

Step	Procedure
1	Select <b>Defined Area(s)</b> for the Printer Driver to print the resin black (K) panel for all black found only in a desired and defined area or areas.

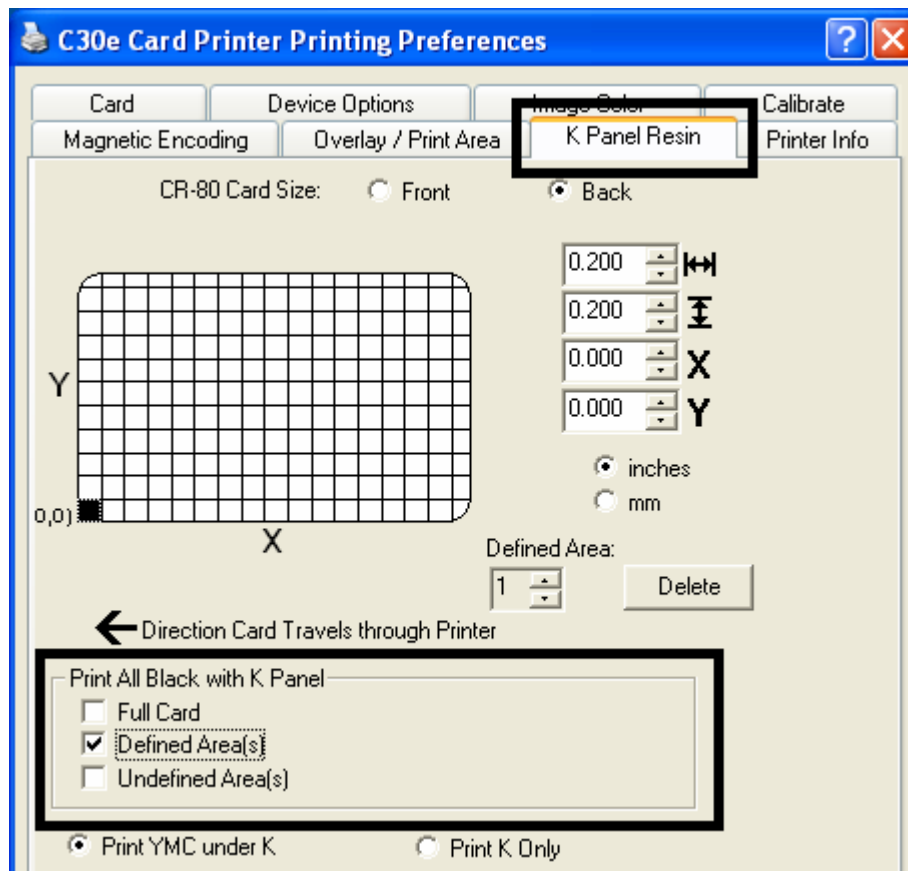

### Selecting the Undefined Area(s) option (Front and Back options)

Step	Procedure
1	Select <b>Undefined Area(s)</b> for the Printer Driver to print the resin black (K) panel for all black found only in the space outside the defined areas. ( <b>Note:</b> In the card grid, black indicates the area in which the resin black (K) panel will be printed.)

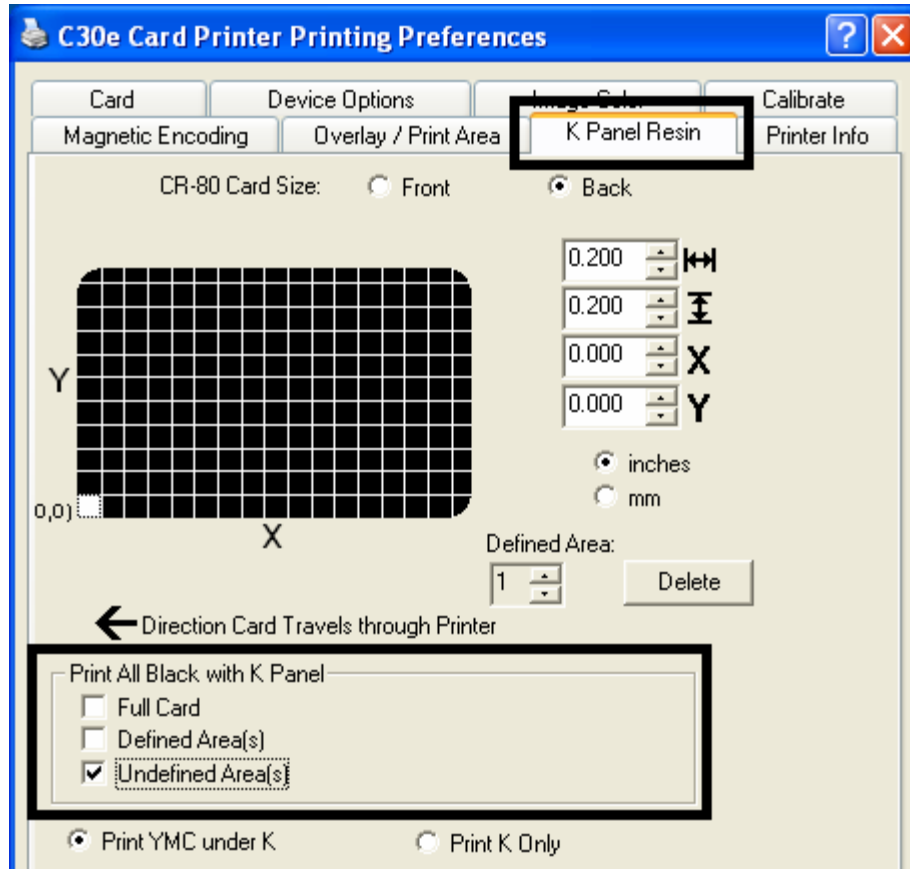

## Selecting the Defined Area(s) function (Front and Back options)

To define an area, refer to the following steps:

Step	Procedure
1	<p>Click <b>Defined Area(s)</b>. (<b>Note:</b> This will activate the card grid in the upper half of the window. It is through this card grid that up to five areas can be defined.)</p> <p>When the card grid is first activated, a small square will appear at its default size of .2" x .2" / 5mm x 5mm and at its default location in the lower left-hand corner (0, 0). This square represents the first defined area.</p> <p>(<b>Note:</b> Changing the orientation of the card in the Card Tab will change the appearance of this Tab.)</p>

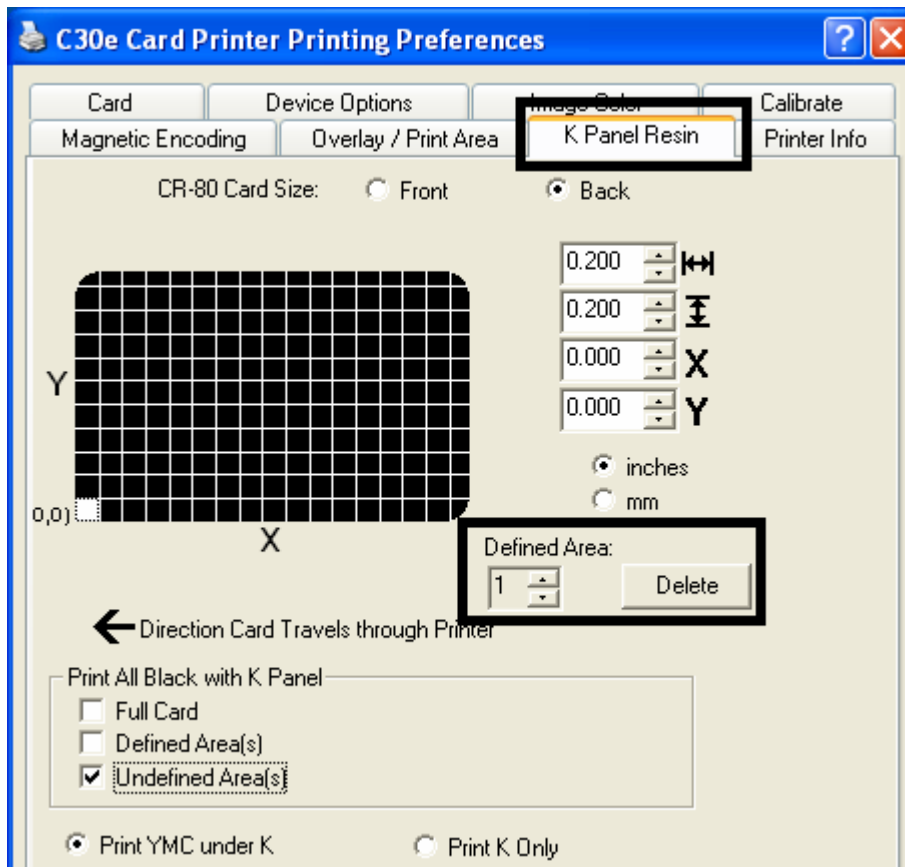

2	<ol style="list-style-type: none"> <li>a. Determine the area of the card necessary to define. In the sample (below), this area is indicated by the dashed outline.</li> <li>b. Determine the size of this area by actually printing a card and looking at it in the same orientation as when it exits the Printer.</li> </ol>
---	---

3	Measure the total size for the area and enter those dimensions into the dimension boxes. ( <b>Note:</b> The minimum size an area can be is .2" x .2" / 5mm x 5mm.)
---	--

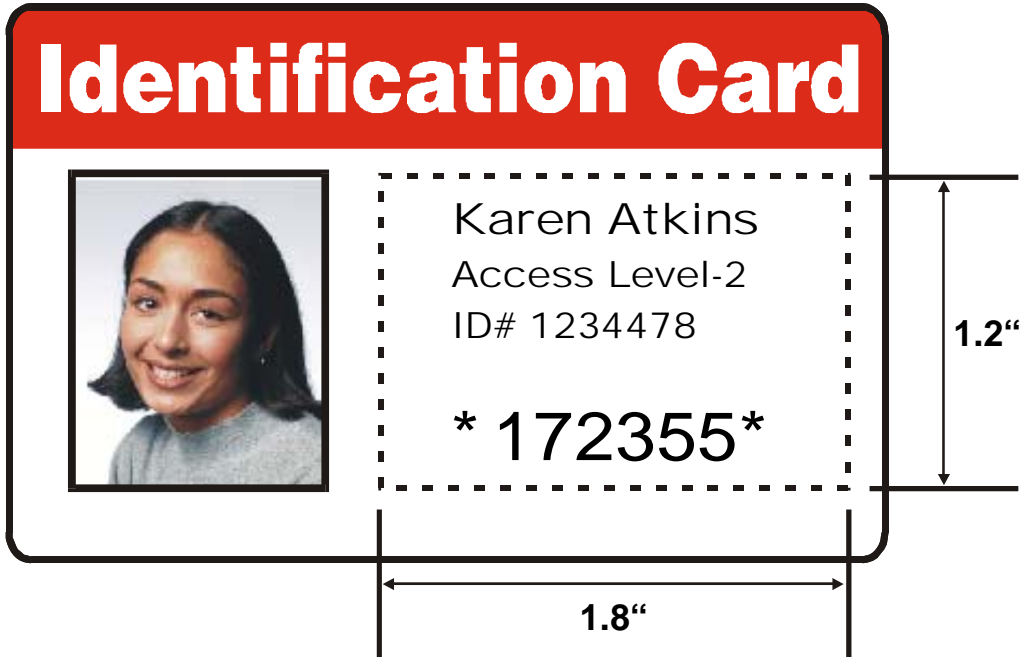

4	<p>a. Once the area is sized properly measure from the lower left corner of the card up and over to the lower left corner for the defined area to begin.</p> <p>b. Enter these values into the X and Y boxes.</p> <p>(<b>Note:</b> The card grid lines are spaced at .2 inch / 5mm intervals.)</p>
5	<p>a. Print the card design and note how the image is oriented on the card as it ejects from the Printer. (<b>Note:</b> The location of a defined area is based on the card orientation as it exits the Printer.)</p> <p>b. Measure the defined area location based on the printed card. (<b>Note:</b> If selecting <b>Rotate Front 180 Degrees</b>, the image will appear upside-down as it exits the Printer. In this case, position the defined area opposite to the measurement from the onscreen card design, which will appear right side up.)</p>

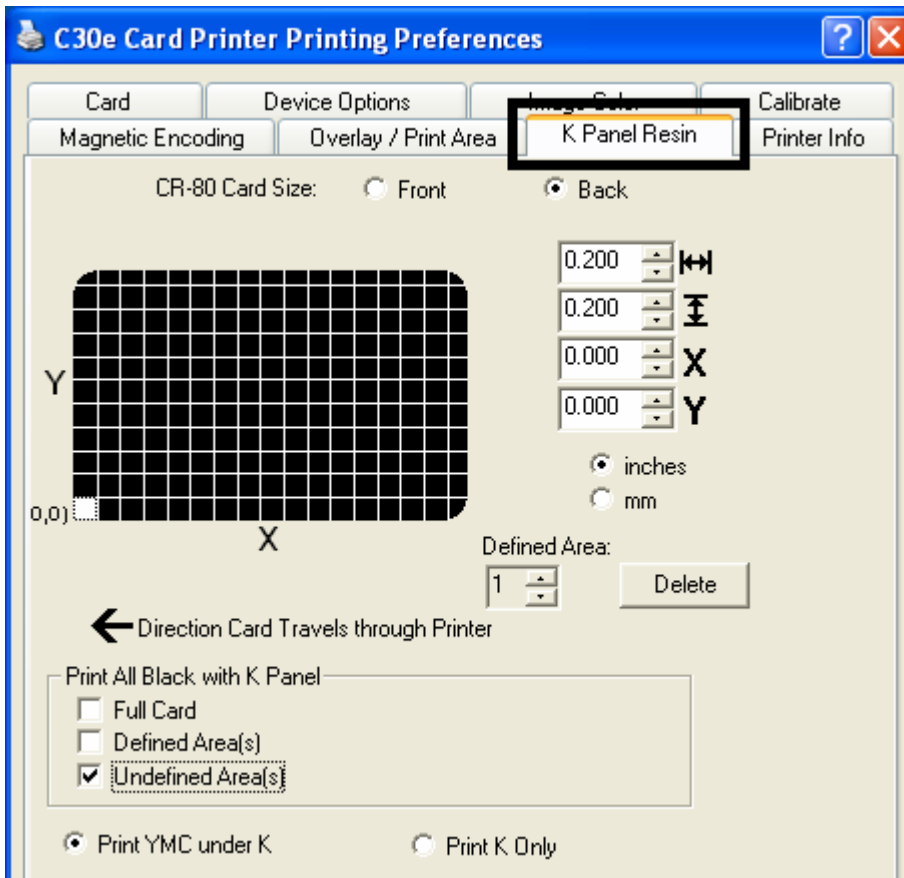

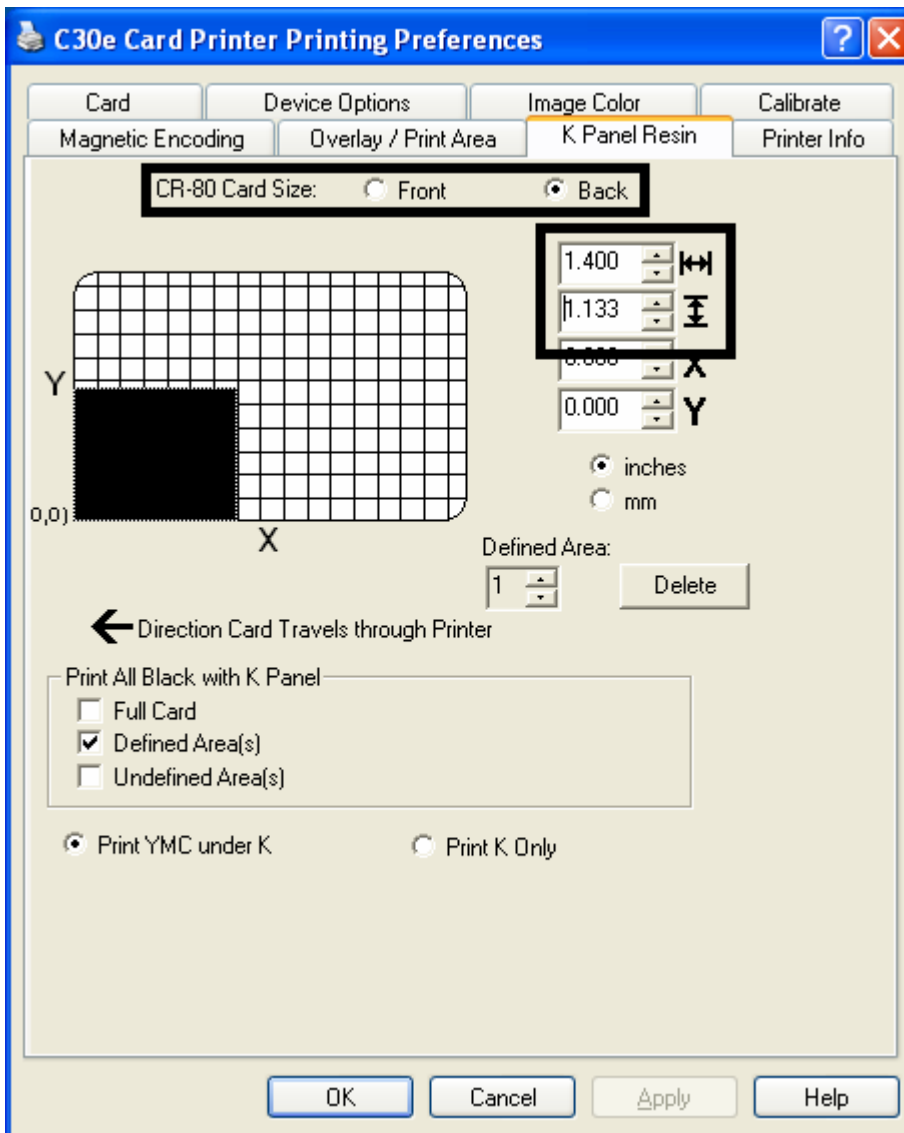



Refer to the previous procedure.

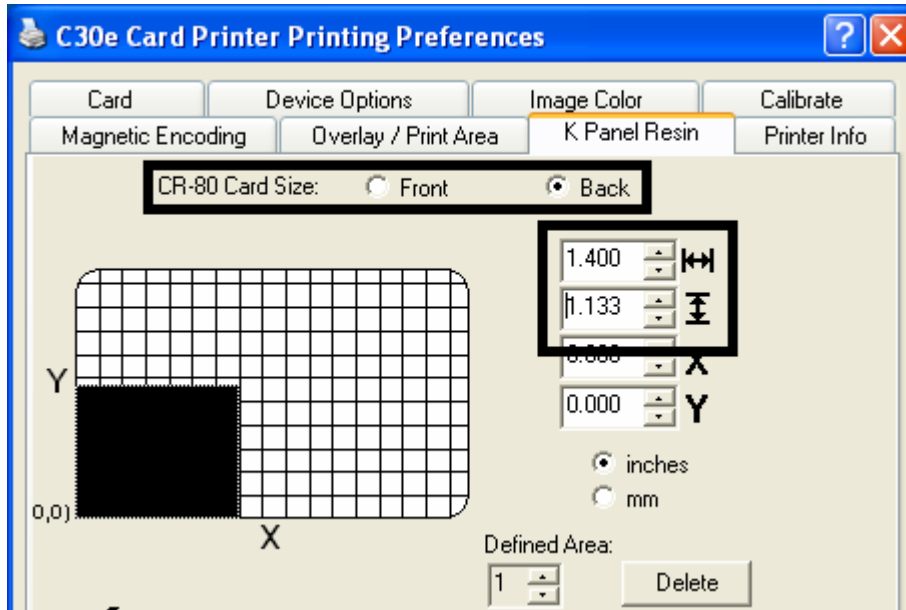

6	Define another area by clicking the <b>Defined Area</b> up arrow. ( <b>Note:</b> Another .2" x .2" / 5mm x 5mm area will appear in the lower left-hand corner. This is the location in which all newly defined areas will first appear.)
7	<ul style="list-style-type: none"> <li>• Use the Defined Area arrows to navigate back and forth from area to area. (<b>Note:</b> The active area will always be highlighted with a dotted outline. Up to 5 areas can be defined.)</li> <li>• New areas are always created in the same position with the same size so it is recommended to move or resize them as they are created.</li> <li>• All five defined or undefined areas can be added without moving the previous one to another location. The up arrow on the Defined Area control can be activated five times in a row and there are five areas added. After five areas are added there appears to be only one until you move each one to a different location.</li> </ul>
8	Delete an area by using the Defined Area arrows to select the area and clicking <b>Delete</b> . ( <b>Note:</b> If all areas are deleted, the K Panel Resin options will automatically be deselected.)



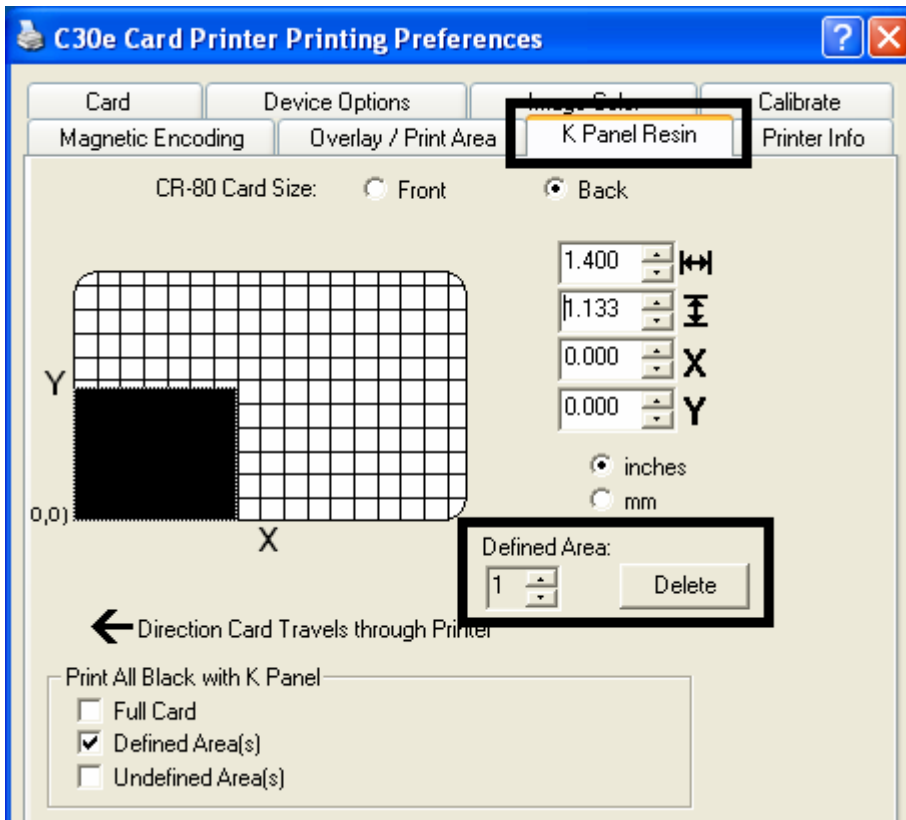

## Selecting the Print YMC under K and Print K Only options

Step	Procedure
1	<p>Select between the <b>Print YMC Under K</b> and <b>Print K Only</b> options. (<b>Note:</b> When the <b>Print YMC Under K</b> option is selected, all black in the designated areas will print with the Yellow (Y), Magenta (M) and Cyan (C) Ribbon panels directly beneath the resin black (K) panel.)</p> <p><b>OR</b></p> <p>Select this option if printing resin black text or bar codes onto a colored background to provide a more gradual transition between the two.</p>
2	<p>Select <b>Print K Only</b> if printing resin black onto a white background to maximize the sharpness of printed text and bar codes. (<b>Note:</b> When this option is selected, all black in the designated areas will print only with the resin black (K) panel.)</p>



# Using the Printer Info tab (DTC400e/C30e/M30e)

Use the options on this tab to view information about the Ribbon installed in the Printer.

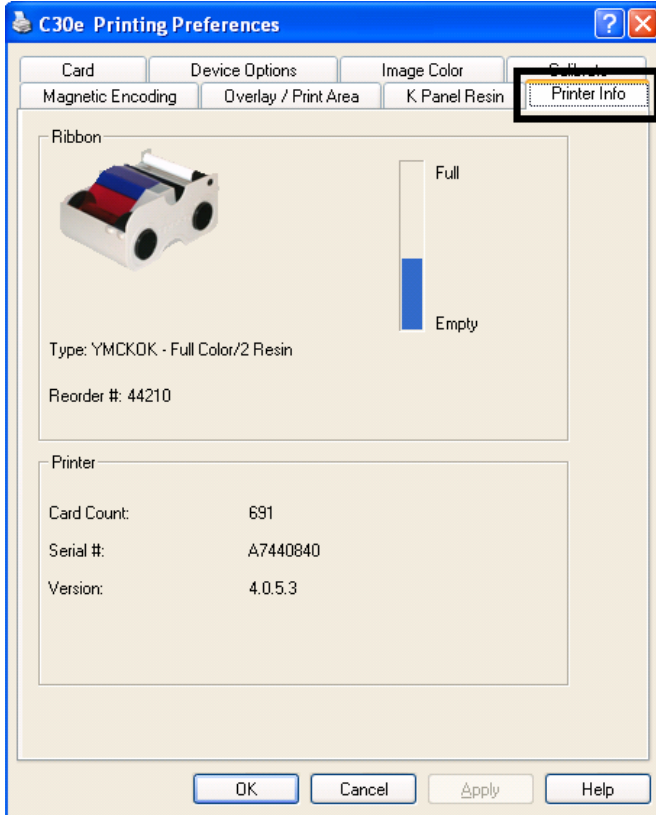

C30e

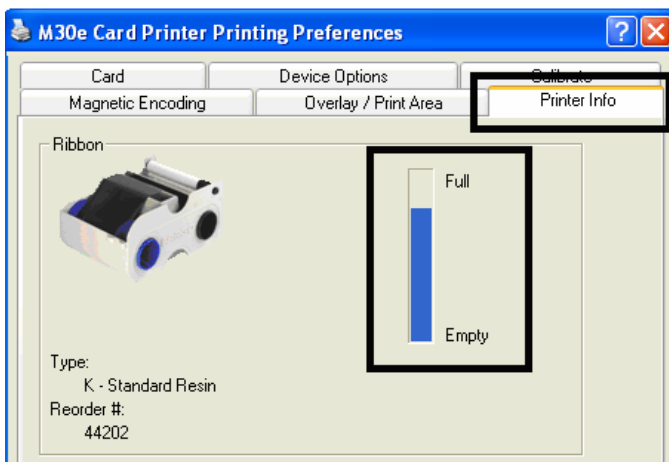

M30e

## Reviewing the Ribbon Information

Step	Procedure
1	Use the Ribbon information to determine which Ribbon is being used to print with and its part number.

## Reviewing the Ribbon Level Indicator

Step	Procedure
1	Use the Ribbon Level indicator to view approximately how much Ribbon is left.

## Using the Printer Calibration Utility (DTC400e/C30e/M30e)

Access the Settings dialog box via the **Settings** button on the Calibrate tab. Use the adjustment mode to change the Printer's internal settings. (**Note:** The Card Printer is equipped with an internal adjustment mode programmable through the Settings dialog box. This dialog box is accessible only if the Printer is powered ON, it is in Ready Mode and it is properly connected to the PC.)



**Caution!** These settings are optimized at the factory. In most cases, these settings can be used without changing them.

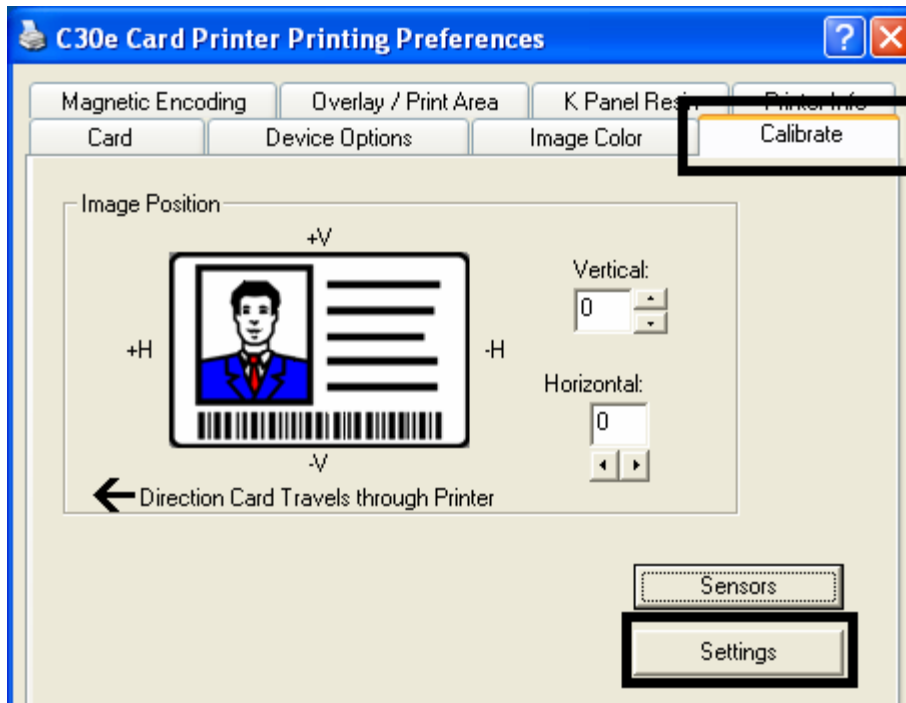

## Using the Image Darkness Option

Use this option to set the overall darkness of the printed image by increasing or decreasing the amount of heat used by the Printhead when printing.

Step	Procedure
1	<p>Lighten the printed image by clicking the down arrow ▼ to enter a negative value and decrease the amount of Printhead heat.</p> <p><b>OR</b></p> <p>Darken the image by clicking the up arrow ▲ to enter a positive value and increase the amount of Printhead heat.</p> <p> <b>Caution:</b> If the value is set too high, the Ribbon may jam or even break.</p>



## Using the Print Top of Form Option

Use this option to adjust the lengthwise or horizontal position of the printed image on a card so it appears centered. (**Note:** When adjusting this value, keep in mind that cards always remain in the same landscape orientation while moving through the Printer.)

The diagram (below) represents how the printed image will move in relation to the fixed card position as a positive or negative Image Placement value is entered.

Step	Procedure
1	<p>Enter a negative value to move the printed image toward the leading edge of the card or the card output to the side of the Printer.</p> <p><b>OR</b></p> <p>Enter a positive value to move the printed image toward the trailing edge of the card or the card input to the side of the Printer.</p> <ul style="list-style-type: none"> <li> <b>Maximum Adjustment Range:</b> The maximum adjustment range is <math>\pm 127</math>. As a rule, 20 equals about .030"/. 8mm, which is about the same as the thickness of a standard CR-80 size card.                 </li> </ul> <p> <b>Caution:</b> If the negative value is set too high, the print Ribbon may break.</p>

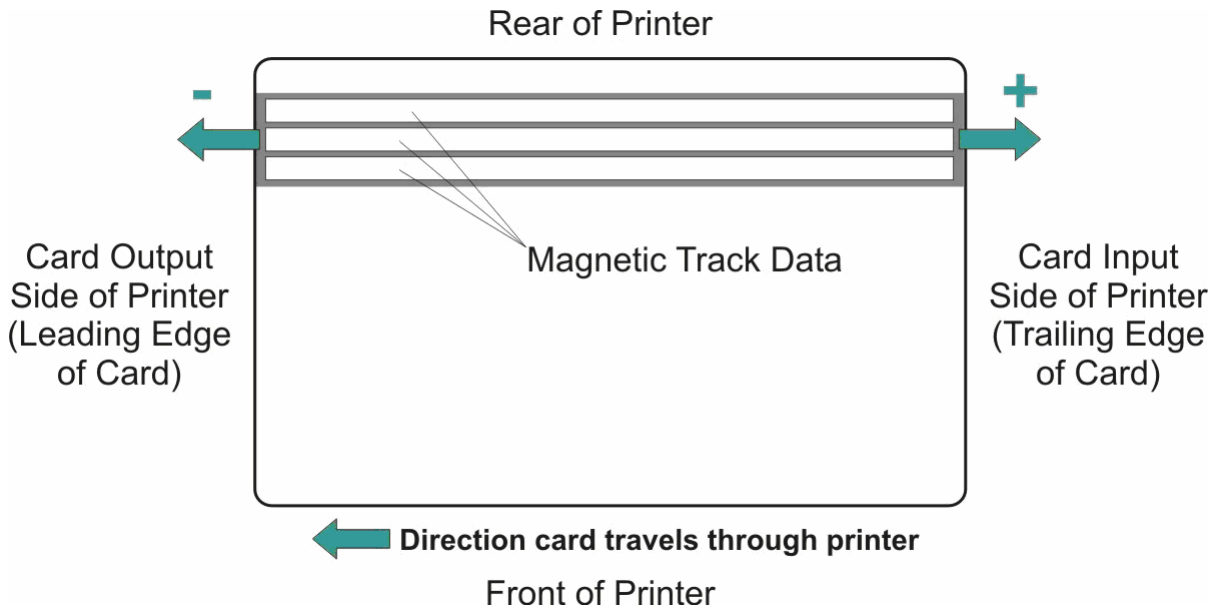

## Using the Print End of Form Option

Use this option to reduce or increase the overall printable area in order to optimize edge-to-edge printing toward the trailing edge of a card. (**Note:** When adjusting this value, keep in mind that cards always remains in the same position while moving through the Printer.)

The diagram (below) represents how the end of form will move in relation to the fixed card position as a positive or negative Print End of Form value is entered.

Step	Procedure
1	<p>Enter a negative value to reduce the Print End of Form and move the end of the printable area more toward the leading edge of the card.</p> <p><b>OR</b></p> <p>Enter a positive value to increase the print length and move the end of the printable area more toward the trailing edge of the card.</p> <p>a. <b>Maximum Adjustment Range:</b> The maximum adjustment range is <math>\pm 127</math>. As a rule, 20 equals about .030"/. 8mm, which is about the same as the thickness of a standard CR-80 size card.)</p>

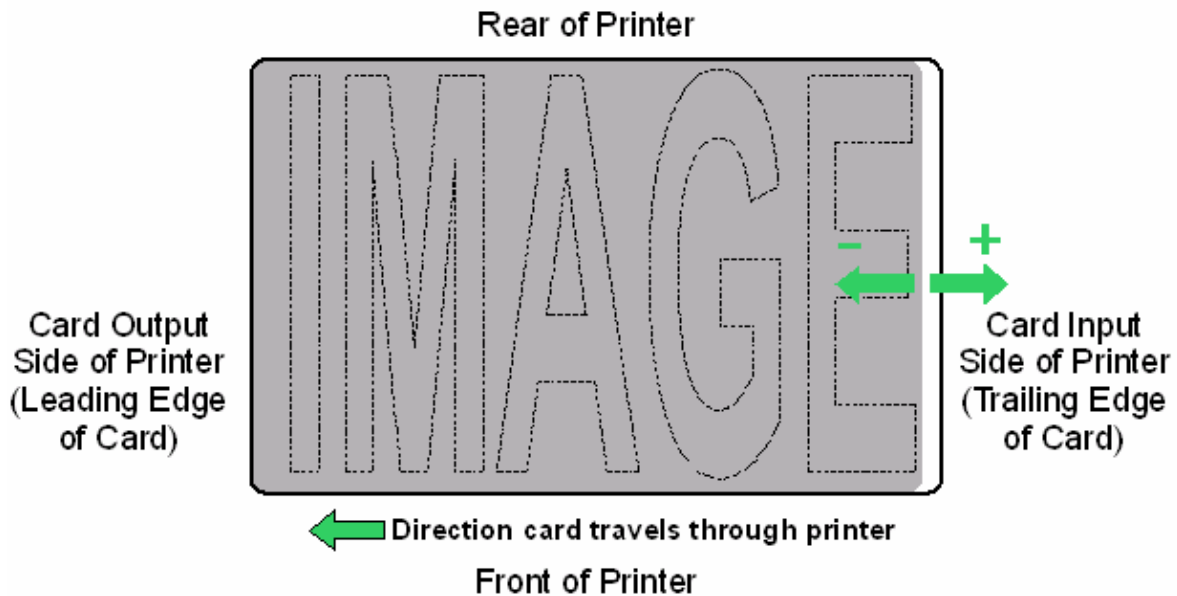



## Using the Print Left of Form Option

Use this option to adjust the vertical position of the printed image on a card so it appears centered. (**Note:** When adjusting this value, keep in mind that cards always remain in the same landscape orientation while moving through the Printer.)

Step	Procedure
1	<p>Enter a negative value to move the image towards the bottom edge of the card (See image below),</p> <p><b>OR</b></p> <p>Enter a positive value to move the image towards the back top edge of the card (see image below).</p> <ul style="list-style-type: none"> <li> <b>Maximum Adjustment Range:</b> The maximum adjustment range is -75 to +15. As a rule, 10 equals about .030"/. 8mm. This is about the same as the thickness of a standard CR-80 size card.                 </li> </ul>

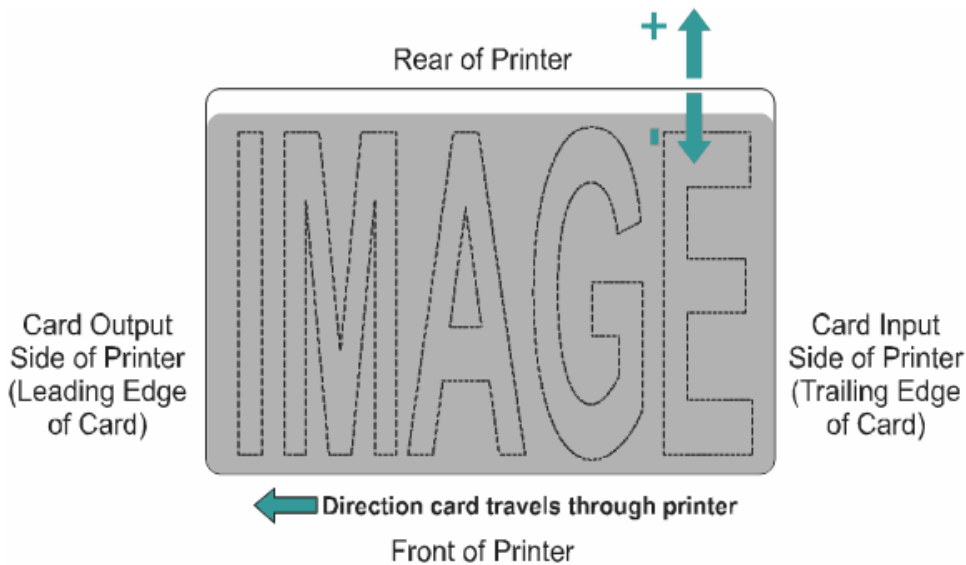

## Using the Magnetic Encoder Voltage Offset Option

Use this option to adjust the voltage of the Magnetic Encoder.

- Encoder voltage is set from the factory at a default of 7.24vdc for Hi-Co Magnetic cards and 2.54vdc for Lo-Co Magnetic cards.
- Depending on the cards that are being used, it may be necessary to adjust the Encoder voltage out of default.

See the next two procedures for instructions on adjusting the Magnetic Encoder Voltage. (**Note:** The required Encoder voltage for the cards will need to be known in order to properly set the Encoder Voltage Offset value. This information should be available through the card manufacturer or reseller.)

## Adjusting the Hi-Co Voltage Offset

Step	Procedure
1	Identify the Magnetic Encoder voltage required by the cards. ( <b>Note:</b> The required encoder voltage for the cards will need to be known in order to properly set the Encoder Voltage Offset value. This information should be available through the card manufacturer or reseller).
2	Use the following equation to identify the proper Mag Hi-Co Voltage Offset value <ul style="list-style-type: none"> <li><math display="block">(((36500/((\langle\text{Desired Voltage}\rangle+4.6)/1.23)-1))-2670)/39.0625) - 40) \times -1</math></li> </ul> <b>For example:</b> Required Encoder Voltage = 9vdc <ul style="list-style-type: none"> <li><math display="block">(((36500/((9+4.6)/1.23)-1))-2670)/39.0625) - 40) \times -1 = 15</math></li> </ul>
3	Change the Mag Hi-Co Voltage Offset value. I.E <b>15</b>
4	Use the Diagnostic Utility to run a Magnetic Self test and verify encoded quality.

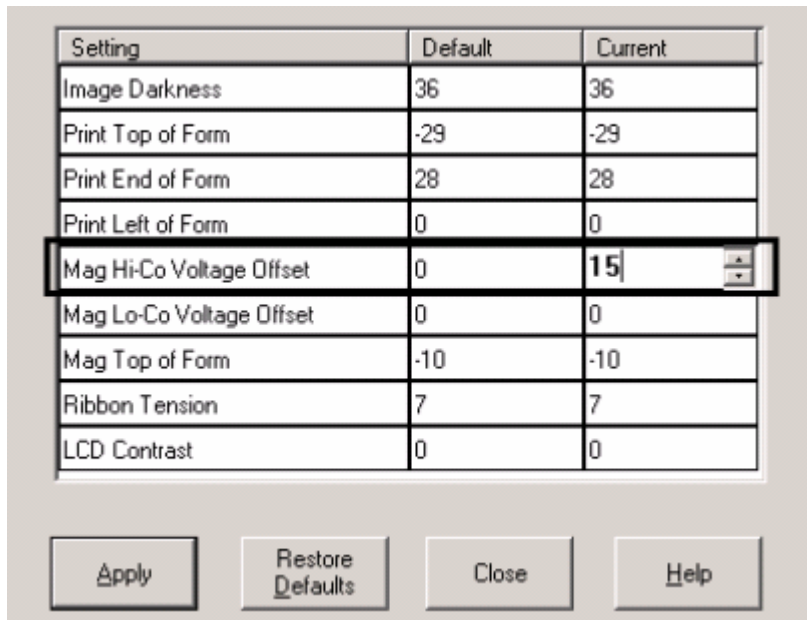

## Adjusting the Lo-Co Voltage Offset

Step	Procedure
1	Identify the Magnetic Encoder voltage required by the cards. ( <b>Note:</b> The required encoder voltage for the cards will need to be known in order to properly set the Encoder Voltage Offset value. This information should be available through the card manufacturer or reseller).
2	Use the following equation to identify the proper Mag Lo-Co Voltage Offset value <ul style="list-style-type: none"> <li><math display="block">\left( \left( \left( \frac{36500}{\left( \left( \langle \text{Desired Voltage} \rangle + 4.6 \right) / 1.23 \right) - 1} \right) - 2670 \right) / 39.0625 \right) - 126 \right) \times -1</math></li> </ul> <b>For example:</b> Required Encoder Voltage = 1.5vdc <ul style="list-style-type: none"> <li><math display="block">\left( \left( \left( \frac{36500}{\left( \left( 1.5 + 4.6 \right) / 1.23 \right) - 1} \right) - 2670 \right) / 39.0625 \right) - 126 \right) \times -1 = -42</math></li> </ul>
3	Change the Mag Lo-Co Voltage Offset value. I.E -42
4	Use the Diagnostic Utility to run a Magnetic Self test and verify encoded quality.

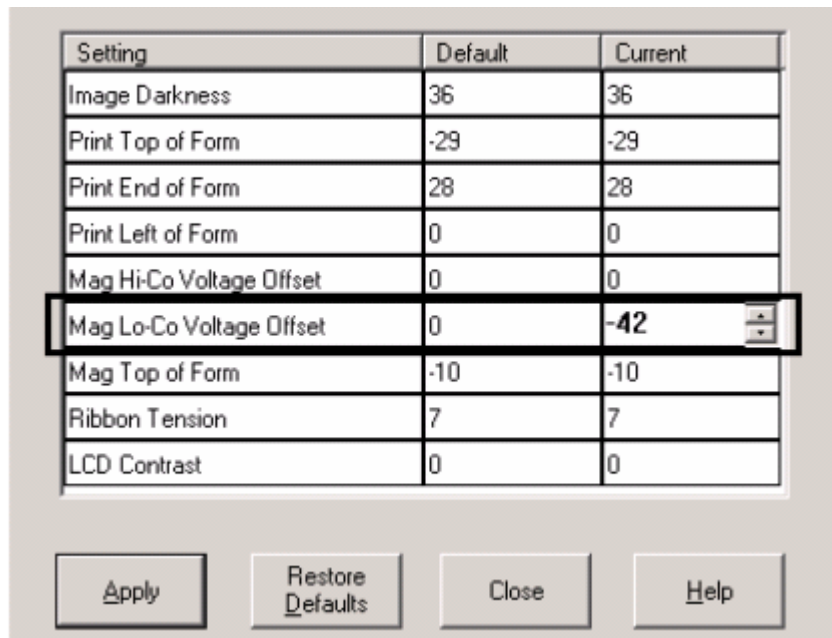

## Using the Mag Top of Form Option

Use this option only if the Printer has a built-in Magnetic Stripe encoder. (**Note:** If so, use this option to shift the starting point of where the Printer will begin encoding the magnetic track data on a card's Magnetic Stripe. When adjusting this value, keep in mind that a card and its Magnetic Stripe will always remain in the same relative position as the card travels through the Printer.)

The diagram (below) represents how the magnetic data will move in relation to the fixed position of a card's Magnetic Stripe as a positive or negative Magnetic Offset value is entered. (**Note:** For this diagram, imagine that the card is transparent and the card's Magnetic stripe can be seen through the top or front side of the card.)

Step	Procedure
1	<p>Enter a negative value to move the start of the magnetic data more toward the leading edge of the card or the card output to the side of the Printer.</p> <p><b>OR</b></p> <p>Enter a positive value to move the start of the magnetic data toward the trailing edge of the card or the card input to the side of the Printer.</p> <ul style="list-style-type: none"> <li>• <b>Magnetic Data Direction:</b> The arrows on these buttons indicate the direction the magnetic data will move on the card's Magnetic Stripe.</li> <li>• <b>Maximum Adjustment Range:</b> The maximum adjustment range is <math>\pm 127</math>. As a rule, 20 equals about .030"/. 8mm.) (<b>Note:</b> Keep this in mind when adjusting this option to avoid over-adjusting.)</li> </ul> <p> <b>Caution:</b> If the negative value is set too high, the Printer may start encoding before the card's Magnetic Stripe reaches the encoding head.</p>

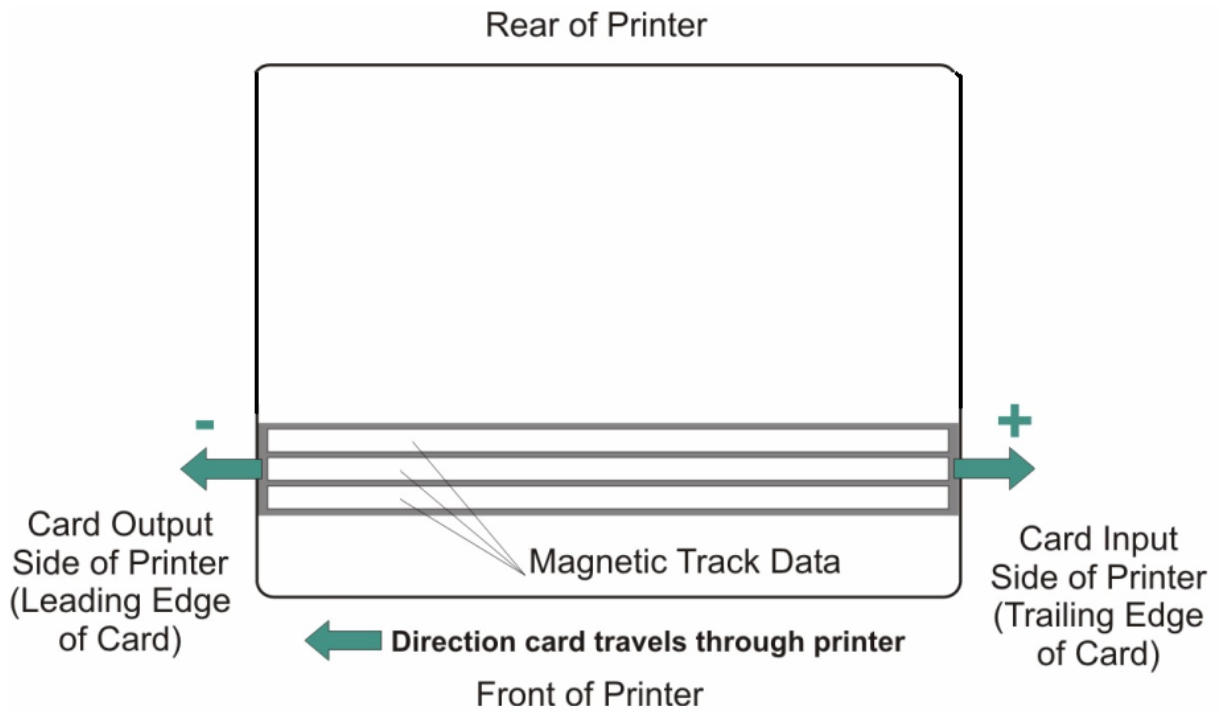

## Using the Ribbon Tension Option

Step	Procedure
1	<p>Use the Ribbon Tension option to increase the amount of tension (drag) on the Ribbon during printing.</p> <p>Enter a negative value to decrease the amount of tension that is placed on the Ribbon during printing</p> <p><b>OR</b></p> <p>Enter a positive value to increases the amount of tension that is placed on the Ribbon during printing.</p>

## Using the Flipper Home Offset Option

Use this option to change the Flipper angle relative to home/horizontal position. This is done in order to adjust angle of travel to and from the Printer and Flipper Module.

Step	Procedure
1	<p>Enter a negative value to position a card to enter the Printer at an upward angle.</p> <p><b>Or</b></p> <p>Enter a positive value to position a card to enter the Printer at a descending angle.</p> <p><b>(Maximum Adjustment Range:</b> The maximum adjustment range is <math>\pm 5.1</math> is approximately 1 degree.)</p>

## Using the Flipper Center Offset Option

Use this option to change the card position on the Flipper Table, relative to the center, for flipping. (**Note:** This is important to maintain the proper clearance with surrounding objects when flipping a card.)

Step	Procedure
1	<p>Enter a negative value to position a card closer to the output of the Printer when the Flipper is in home/horizontal position.</p> <p><b>Or</b></p> <p>Enter a positive value to position a card closer to the output of the Flipper Module when the Flipper is in home/horizontal position.</p> <p><b>(Maximum Adjustment Range:</b> The maximum adjustment range is <math>\pm 127</math>. As a rule, 20 equals about .030"/.8 mm, which is about the same as the thickness of a standard CR-80 size card.)</p> <p> <b>Caution:</b> If the offset is set too high or low, the card may jam in the Flipper Module when flipping.</p>



## Using the Flipper Smart Angle Offset Option

Use this option to change the Flipper angle relative to the default smart card loading position. This is done in order to adjust travel to and from the Flipper and the Smart Card Docking Module.

Step	Procedure
1	<p>Enter a negative value to decrease the amount of Flipper angular movement from the home position to the smart card loading position.</p> <p><b>Or</b></p> <p>Enter a positive value to increase the amount of Flipper angular movement from the home position to the smart card loading position.</p> <p><b>(Maximum Adjustment Range:</b> The maximum adjustment range is <math>\pm 5</math>. 1 is approximately 1 degree.)</p>

## Using the Resin Heat (K) Adjustment (Settings)

Printer uses when printing with the resin black panel(s) of a full-color Ribbon or when printing with a resin-only Ribbon by adjusting the **Resin Heat** slide.

Step	Procedure
1	<p>Adjust the Resin Heat, Front (K) or the Resin Head, Back (K) as needed.</p> <ul style="list-style-type: none"> <li>• Move the slider to the left to cause less heat to be used in the printing process, causing resin images to be lighter or less saturated.</li> </ul> <p><b>OR</b></p> <ul style="list-style-type: none"> <li>• Move the slider to the right to (a) cause more heat to be used or (b) cause the resin image to be darker or more saturated.</li> </ul> <p>(<b>Note:</b> This control can be helpful for fine-tuning the transfer of resin text and bar codes.)</p>

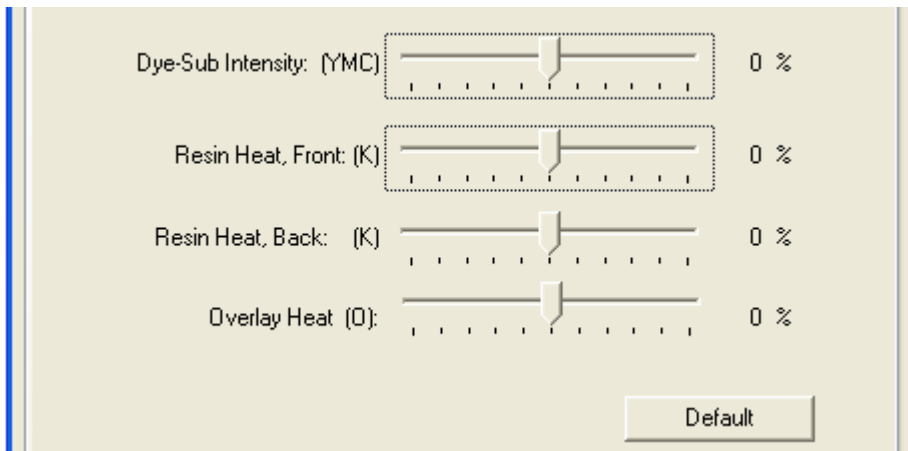

## Using the Print Temperature Offset

Step	Procedure
1	<p>Adjust the printing temperature for the rewriteable cards as needed.</p> <ul style="list-style-type: none"> <li>• Increase the <b>Current Setting</b> to cause more heat to be used in the printing process.</li> </ul> <p><b>OR</b></p> <ul style="list-style-type: none"> <li>• Decrease the <b>Current Setting</b> to cause less heat to be used in the printing process.</li> </ul> <p>(<b>Note:</b> Print Temp Offset provides user ability to control Printhead heat level when the Print (Write) Operation is performed on rewriteable cards. Higher heat level needs to be applied for darker printing on rewriteable cards. A lower setting will produce a lighter image on rewriteable cards accordingly)</p>

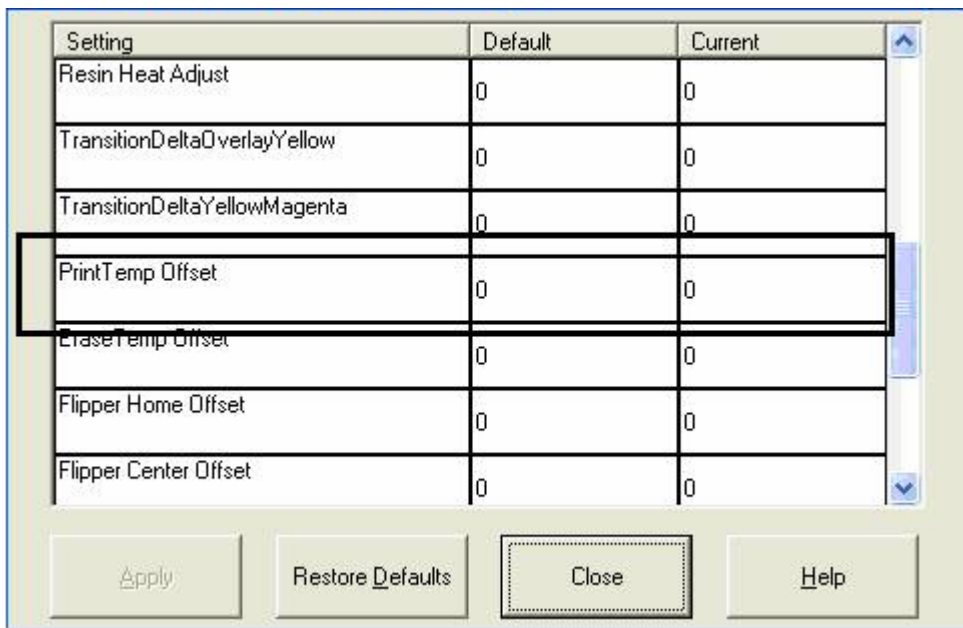

## Using the Erase Temperature Offset

Step	Procedure
1	<p>Adjust the Erase temperature for the rewriteable cards as needed.</p> <ul style="list-style-type: none"> <li>• Increase the <b>Current Setting</b> to cause more heat to be used in the erasing process.</li> </ul> <p style="text-align: center;"><b>OR</b></p> <ul style="list-style-type: none"> <li>• Decrease the <b>Current Setting</b> to cause less heat to be used in the erasing process.</li> </ul> <p>(<b>Note:</b> Erase Temp Offset provides user ability to control the Printhead heat level when the Erase Operation is performed. Appropriate heat levels should be applied for the proper erase process. This setting should be adjusted for proper erasure)</p>

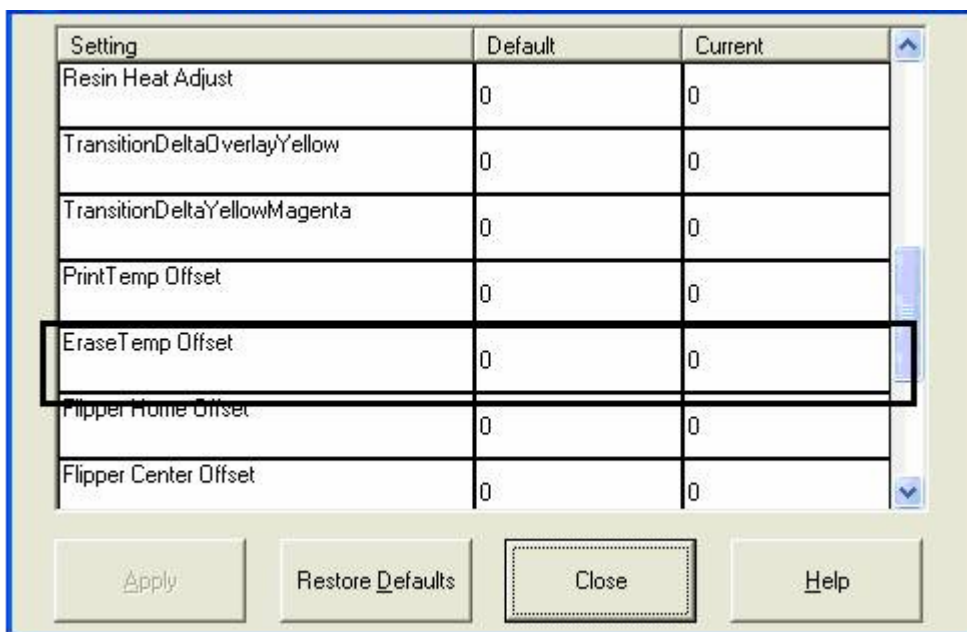

## Using the Flipper Prox Offset Option

Step	Procedure
1	<p>Normally the Prox encoder is installed into Bay1 and no adjustment is necessary.</p> <ul style="list-style-type: none"> <li>• This setting is factory set at 0.</li> <li>• This setting option relates to the Prox encoder installed into Bay 2.</li> </ul>

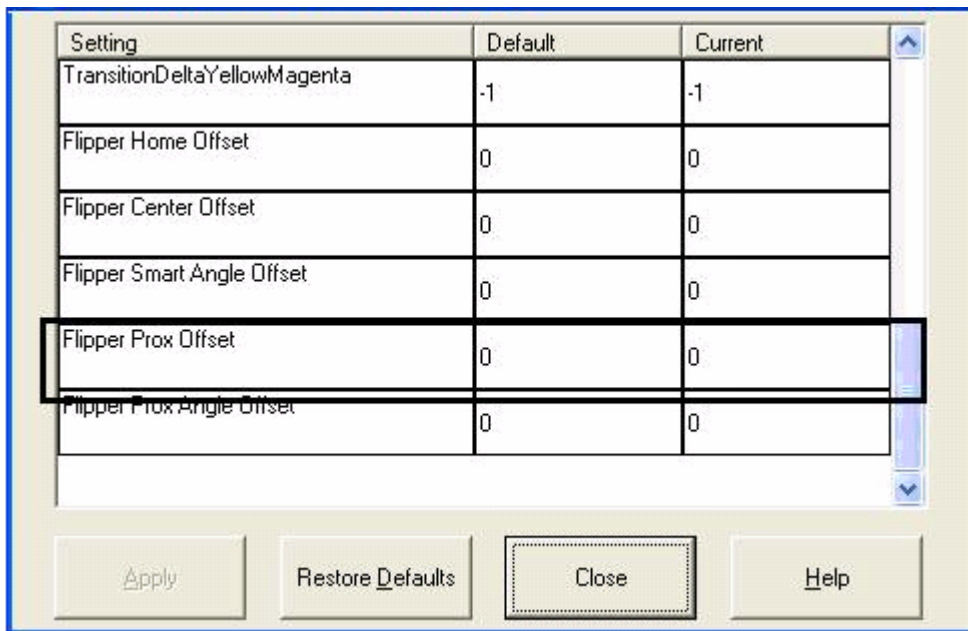

## Using the Flipper Prox Angle Offset Option

Use this option to change the Flipper angle relative to the default Prox card loading position. (**Note:** This is done in order to adjust travel to and from the Flipper and the Prox Docking Module.) Adjust the Flipper Offset (as needed) if the card is not feeding into the E-card Docking Station properly.

Step	Procedure
1	<p>Enter a negative value to decrease the amount of Flipper angular movement from the home position to the smart card loading position.</p> <p><b>Or</b></p> <p>Enter a positive value to increase the amount of Flipper angular movement from the home position to the smart card loading position.</p> <p><b>(Maximum Adjustment Range:</b> The maximum adjustment range is <math>\pm 5</math>. 1 is approximately 1 degree.)</p>

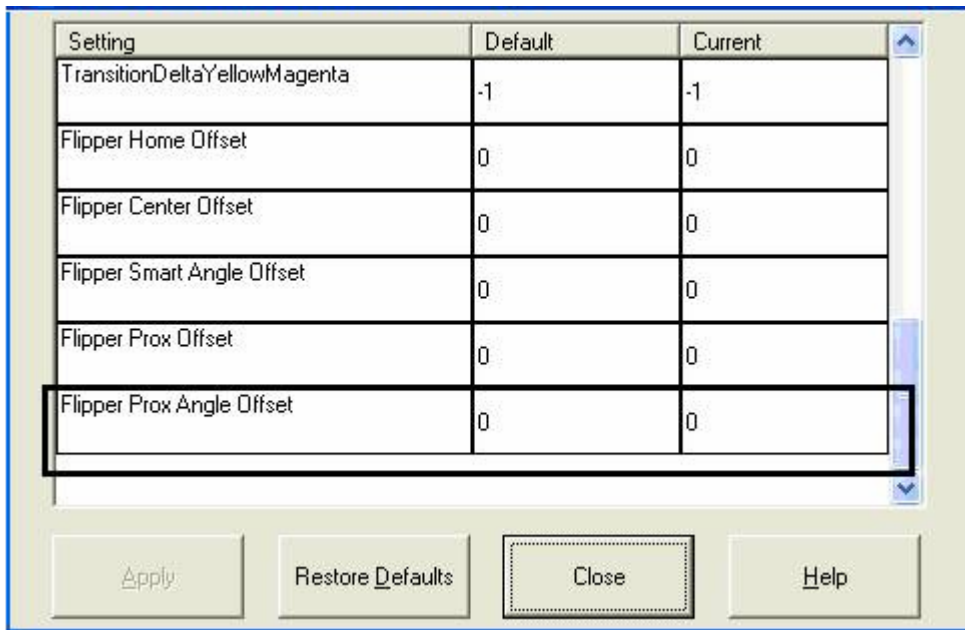

# Section 7: Using the YMCFKO Ribbon in the Workbench

This process allows the user to configure the data that is printed with the fluorescent panel of an YMCFKO or YMCFKOK Ribbon. Any software program may be used to print the special fluorescent panel of the ribbon to a card once the driver and Workbench are set up correctly.

Step	Procedure
1	From the Driver Printing Preferences click on <b>Diagnostics</b> to bring up the Fargo Workbench Printer Utility.

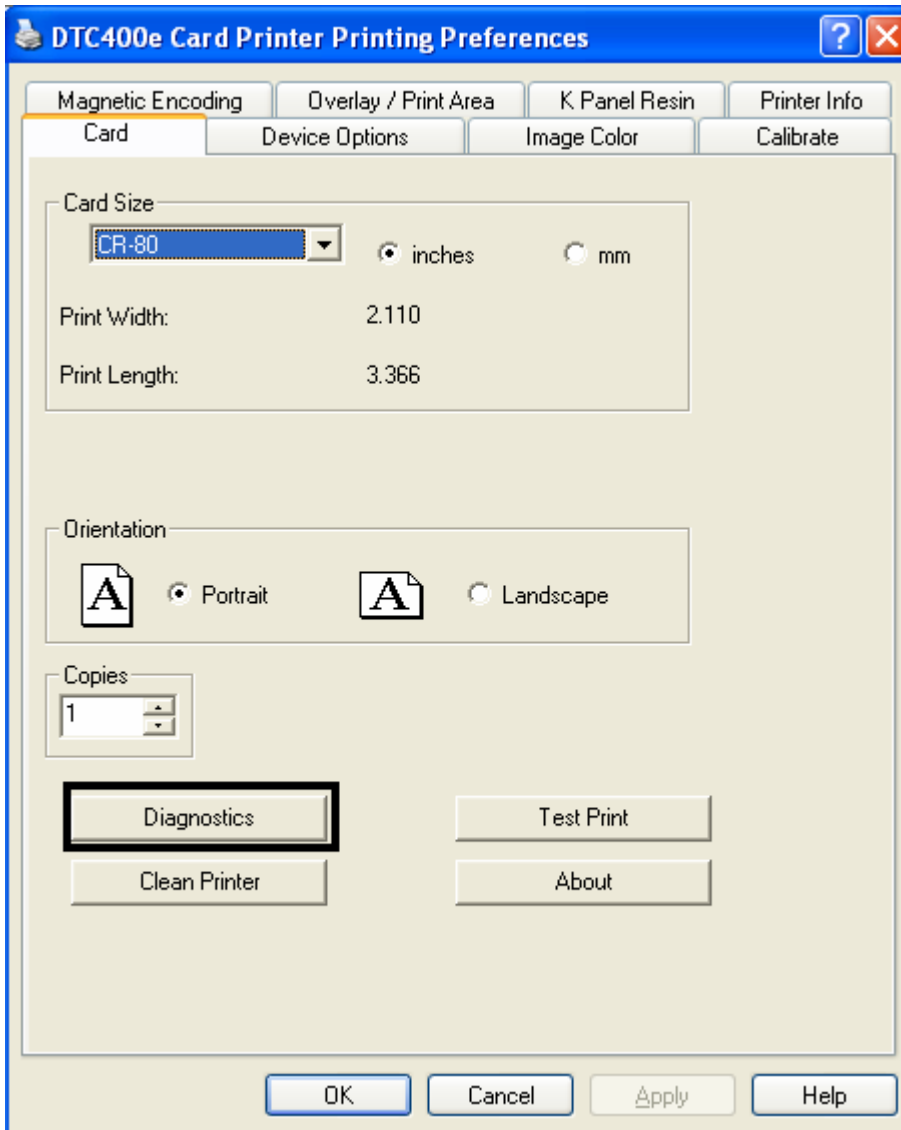

2	Set the ribbon for YMCFKO or YMCFKOK in the Printing Preferences. The Auto Detect button may also be used. The F panel ribbon must be installed for this process to work.
3	Once the driver is set for YMCFKO ribbon and Workbench parameters are set up correctly, the image printed from any software program will show the Florescent images as place on the template.

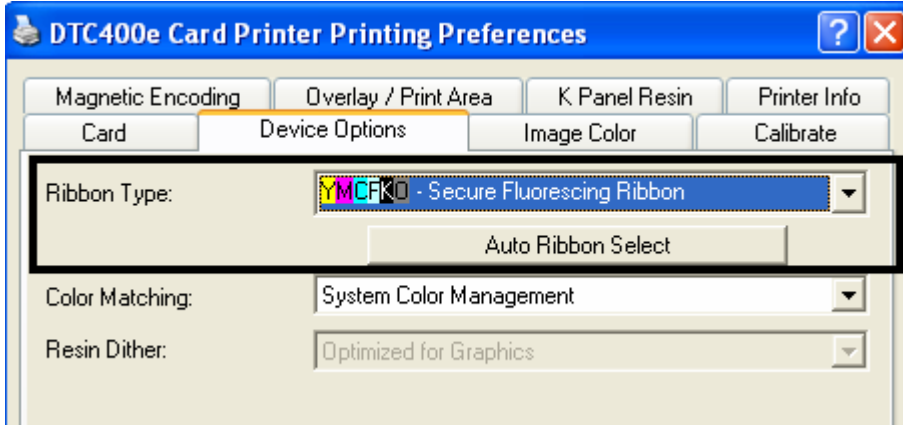

4	Click the <b>Print Security</b> applet group and select the <b>Security Imaging</b> applet. Check the <b>Enable Secure Imaging</b> Checkbox.
---	---



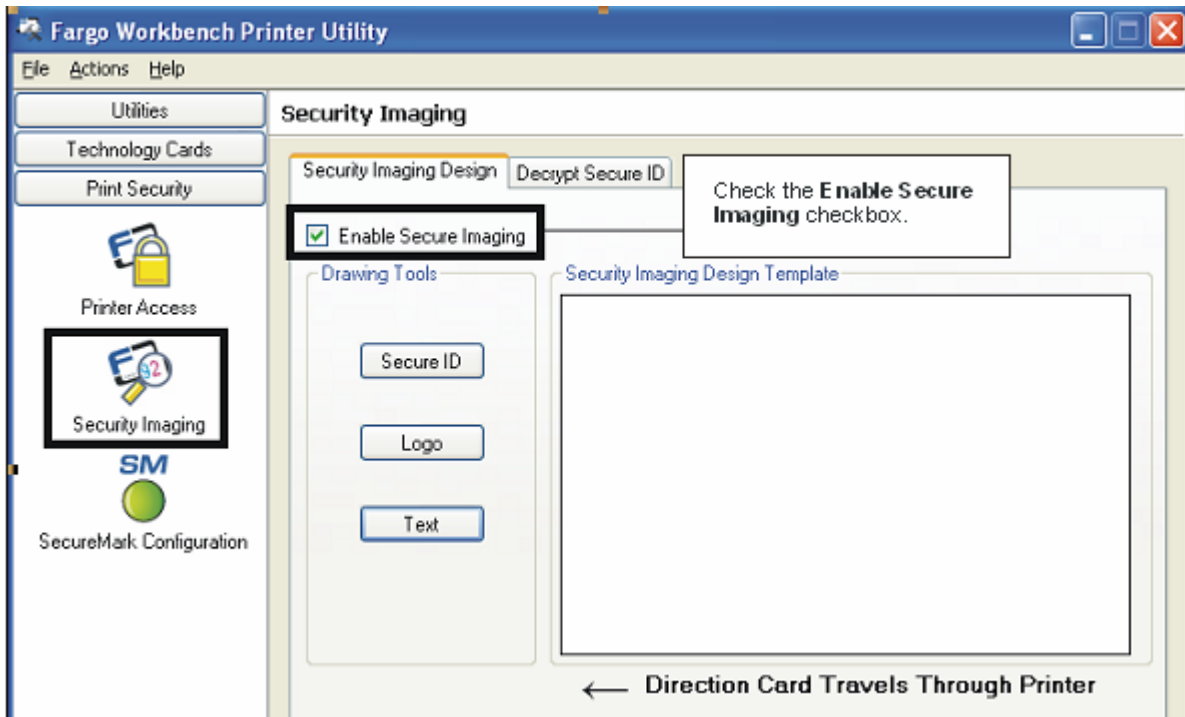

## Adding a Secure ID to the Card

Step	Procedure
5	Click on the <b>Secure ID</b> box on the left. Click and drag a box onto the Template. Move and size as needed.

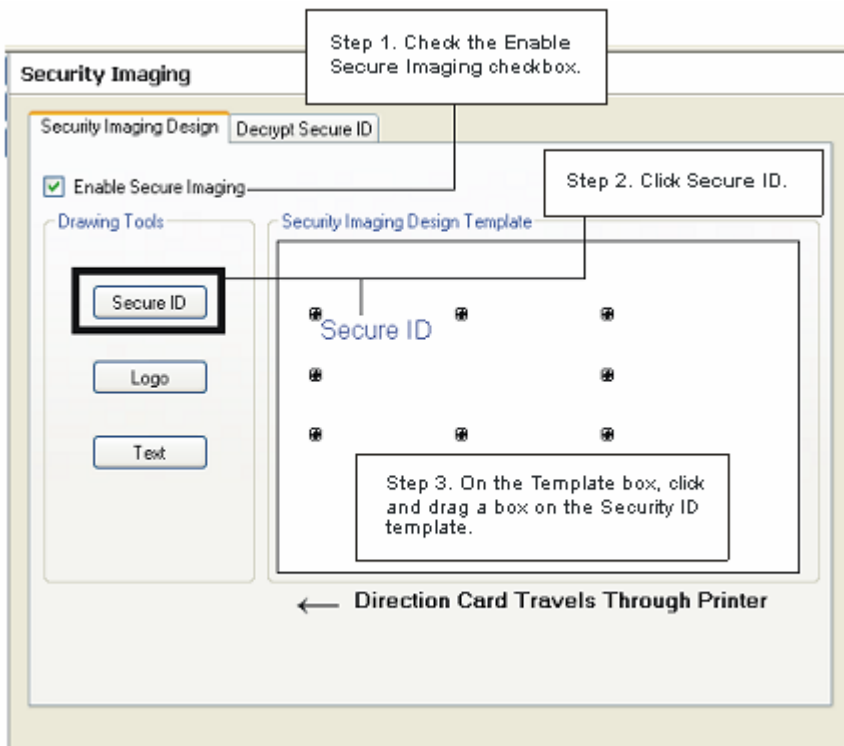

## Changing the Secure ID Properties

Step	Procedure
6	On the Template right click on the Secure ID box for the options shown below.

**Security Imaging**

Security Imaging Design    Decrypt

Enable Secure Imaging

Drawing Tools

Secure ID

Logo

Text

Security Imaging Design Template

Secure ID

- Font
- Move to Fluorescing Panel
- Move to Resin Panel
- Rotate Clockwise
- Rotate Counterclockwise
- Delete

← Direction Card Travels Through Printer

**Step 1.** Check the **Enable Secure Imaging** checkbox.

**Step 2.** Click **Secure ID**.

**Step 3.** On the Template box, click and drag a box on the Security ID template.

**Step 4.** Right mouse click on the Secure ID box for these options:

1. Use the Font options.
2. Move to Fluorescing Panel.
3. Move to Resin Panel.
4. Rotate clockwise.
5. Rotate counter-clockwise.
6. Delete the Secure ID box.

## Adding a Logo to the Card

Step	Procedure
7	Click on the <b>LOGO</b> box on the left. Click and drag a box onto the Template. Move and size as needed.

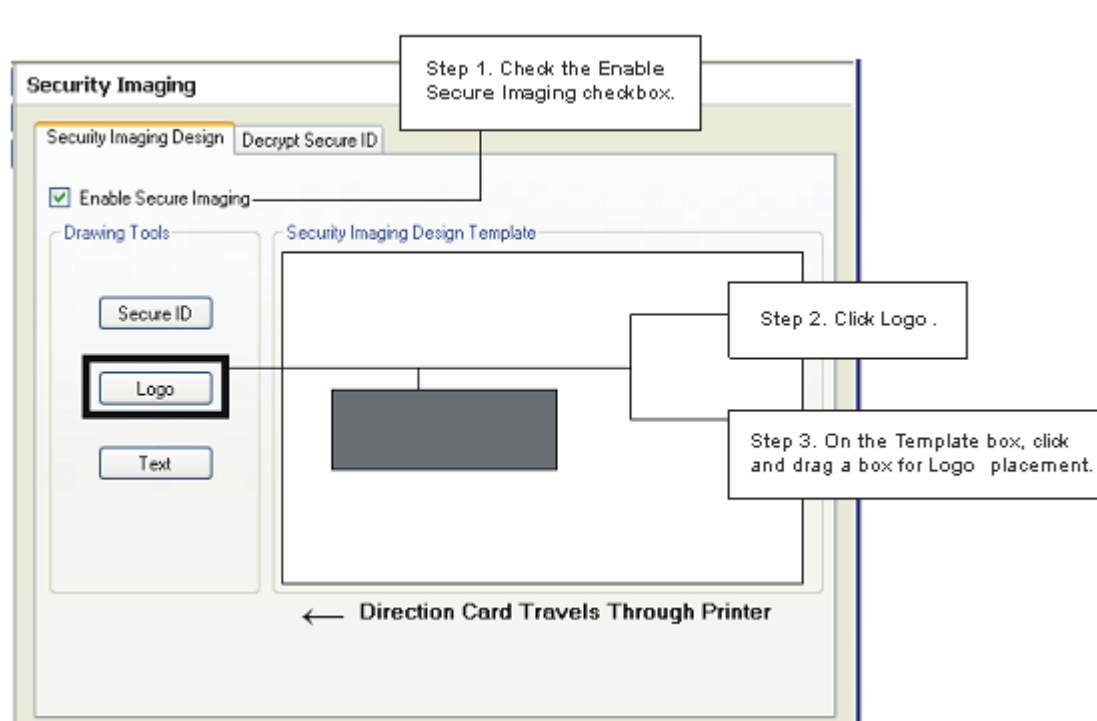

## Changing the Logo Properties

Step	Procedure
8	On the Template right click on the <b>LOGO</b> box for the options shown below.
9	SELECT LOGO FILE. Find the source of the Logo to place on the card. FIT TO FRAME will size the image to fit the box. Once this is set up this logo will print from the software program. This is set up in the background.

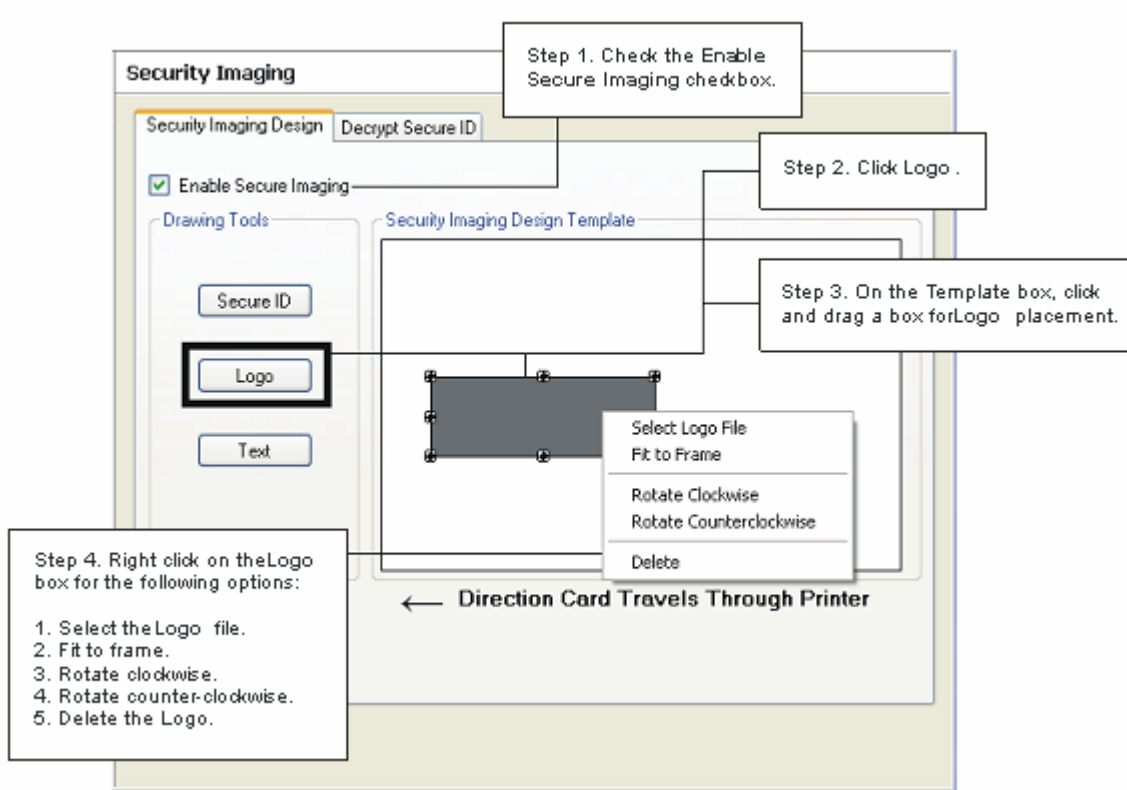

## Adding a Text on the Card

Step	Procedure
10	Click on the <b>TEXT</b> box on the left. Click and drag a box onto the Template. Move and size as needed.

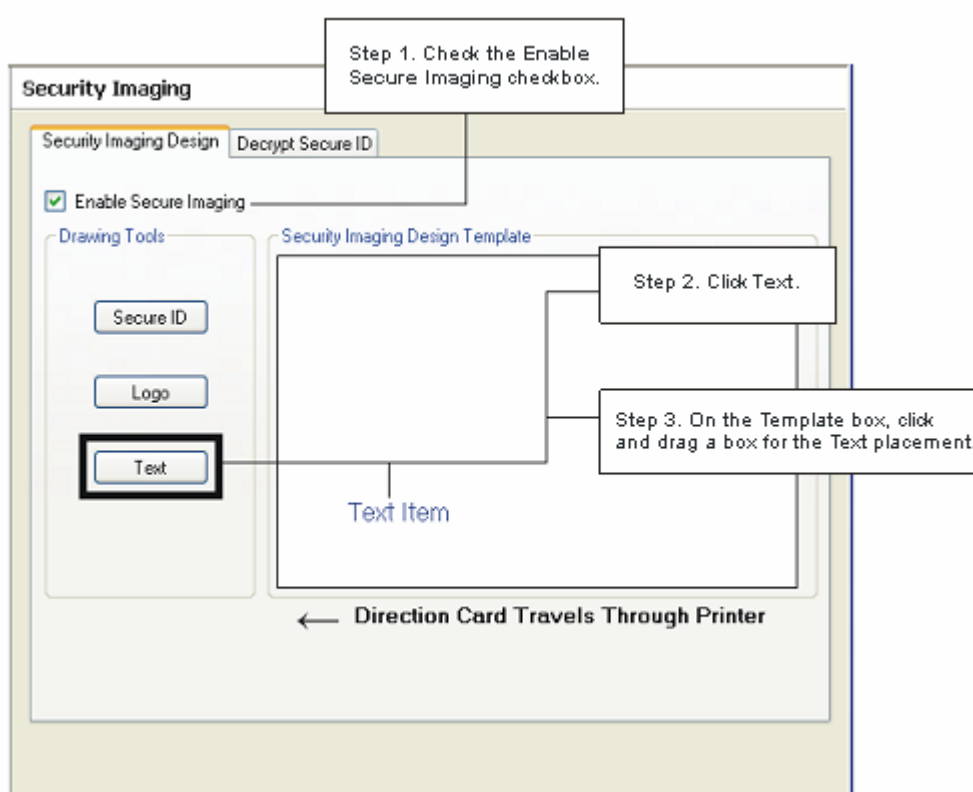

## Changing the Text Properties

Step	Procedure
11	On the Template right click on the <b>TEXT</b> box for the options shown below.
12	<p><b>SAVE</b> this template using <b>FILE- SAVE</b>.</p> <p><b>CLOSE</b> the Workbench.</p> <p>Any Software program file printed with the YMCFKO or YMCFKOK ribbon installed into the printer will print this design with the F panel of the ribbon. It will print the <b>SAME</b> file each time unless you recreate a <b>NEW</b> template.</p>

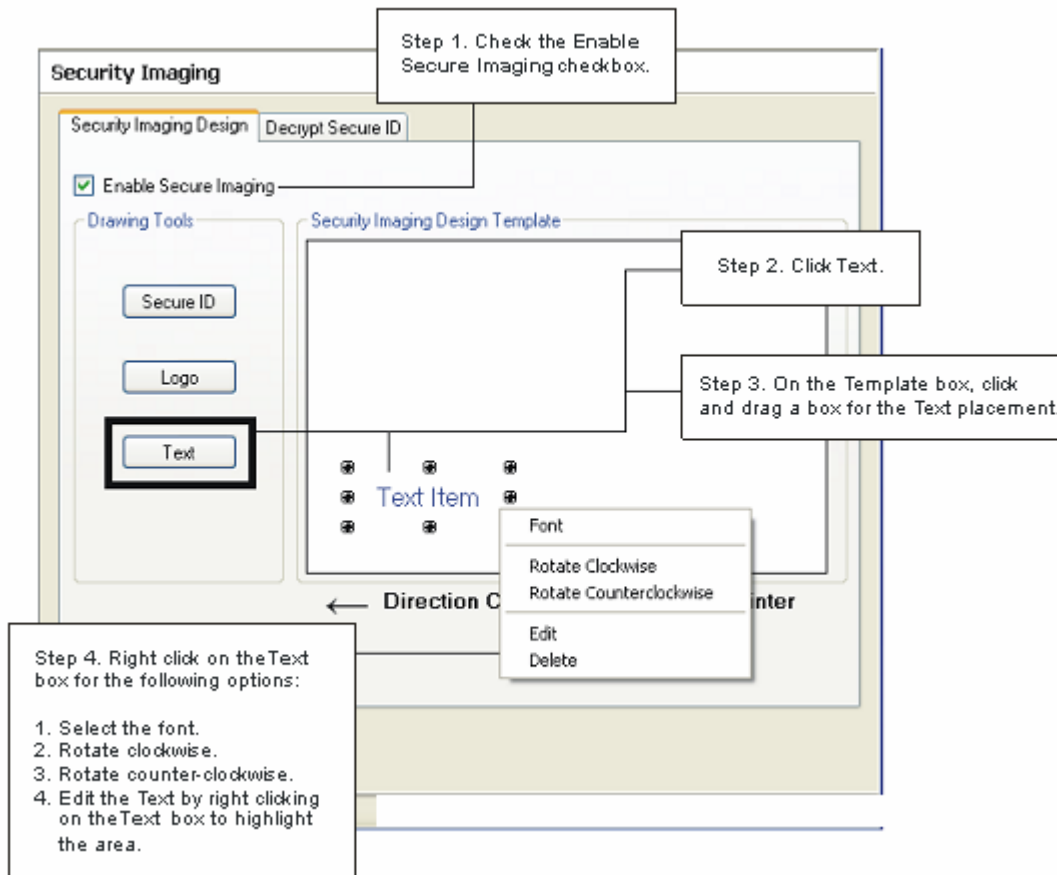

## Fluorescing Panel – Application Specifications

### Inserting Fluorescent Text

Step	Procedure
1	<p>Create fluorescent text in the body of an image by creating a text string which begins with a ~T.</p> <ul style="list-style-type: none"> <li>• For example, the text string of <b>~TFargo</b> would appear on the card as just <b>Fargo</b>.</li> <li>• The location of the text will be dictated by the ~.</li> <li>• The format of the string will be as entered (i.e. font, size, etc.).</li> </ul>

**Text string entered into software application**

~TFargo



**Output on card**

**FARGO®**



## Insert Fluorescent Image

Step	Procedure
1	Save a 1-bit bmp file that is 300x300 dpi somewhere that is easily accessible.
2	<p>In order to import the file onto your card, you will need to paste the path of the image onto your card preceded by ~I.</p> <ul style="list-style-type: none"> <li>For example, <b>~IC:test.bmp</b> would insert the image named <b>test.bmp</b> onto the card.</li> <li>The location of the image will be dictated by the ~.</li> <li>The image will not be scaled. For example, if it is a 300x300 dpi image, it will print 1"x1".</li> </ul> <p>**Please note that the fluorescent text or image can only be printed on the one side of the card.</p>

**Text string entered into software application**



**Output on card**



## Printing Dynamic Text

Step	Procedure
1	<p>If the application supports dynamic text and images, then dynamic text can also be printed with the Fluorescing Panel. Follow the application directions to map a text field to a data source.</p> <p>"~T" must be included in the beginning of the expression or in the beginning of the data.</p>

## Selecting the NONE- Re-Writable Ribbon Type DTC400e/C30e

Follow these instructions:

**Caution:** No Ribbon is used with these cards. Do not load a Ribbon into the printer when using this process. Printing on the Re-Writable card with a Ribbon will ruin the card.

- The default setup is for the printer to first erase the previously-printed card; then write the NEW information on the card. (**Note:** If you are printing to a NEW card, select WRITE ONLY. This will speed up the process. The FULL card is erased and printed; there is no option to select specific areas to erase.)
- To print/erase a certain section use the “Overlay/Print Area” tab in the driver. Select the specific area in the same manner as the print job with the color ribbon.
- To erase many cards, use the Fargo Workbench Re-Writable Card Eraser option. (**Note:** This option does not print only erase.)

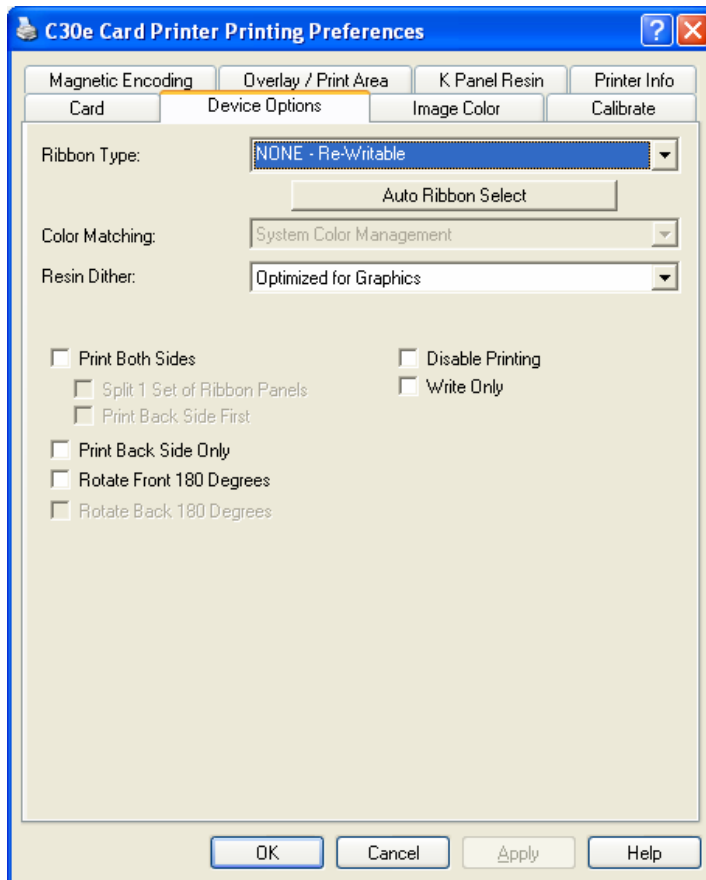

When the Re-Writeable Ribbon is selected, the DTC400e/C30e driver will show only relevant options when the Re-Writeable Ribbon Type is displayed.

Step	Description
1	<p>The following options are <i>removed</i> from the Device Options tab when the Re-Writeable Ribbon Type is selected. See below.</p> <ul style="list-style-type: none"> <li>• Print Both Sides</li> <li>• Print Back Side Only</li> </ul> <p>Rotate Back 180 Degrees (dual side printers only)</p>
2	<p>The following options are <i>available</i> in the Device Options tab when the Re-Writeable Ribbon Type is selected. See below.</p> <ul style="list-style-type: none"> <li>• A Write Only checkbox is displayed when the NONE Re-Writeable Ribbon Type is chosen.</li> <li>• Disable printing</li> <li>• Rotate Front 180 Degrees</li> </ul>

## Using the Workbench (to erase the card)

Step	Description
1	Open the Diagnostic Tool box.

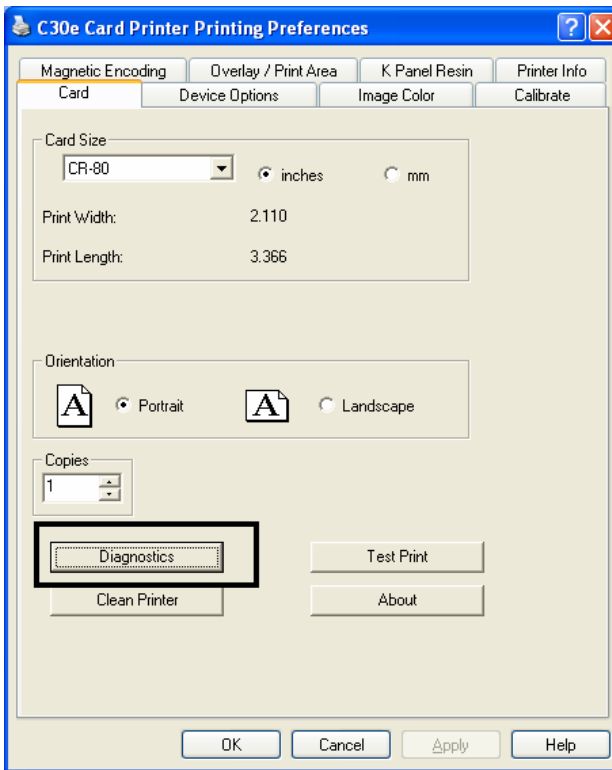

2	Select the <b>Re-Writable Card Eraser</b> option
---	--

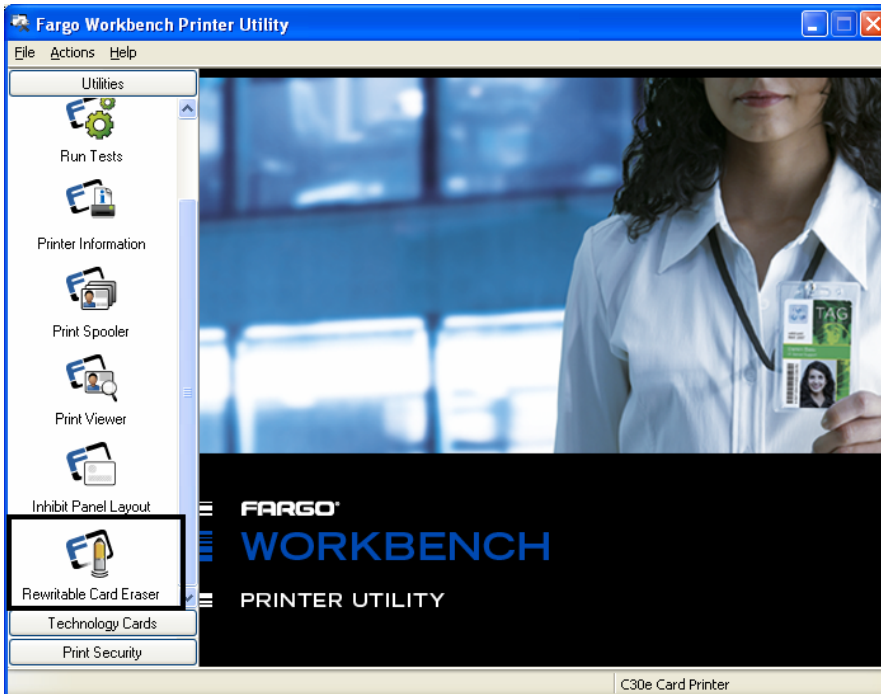

3	Select the number of cards to be erased. Click on the <b>Erase</b> button. ( <b>Note:</b>
---	---

This will erase the full card. The card may be stored or printed on again.)

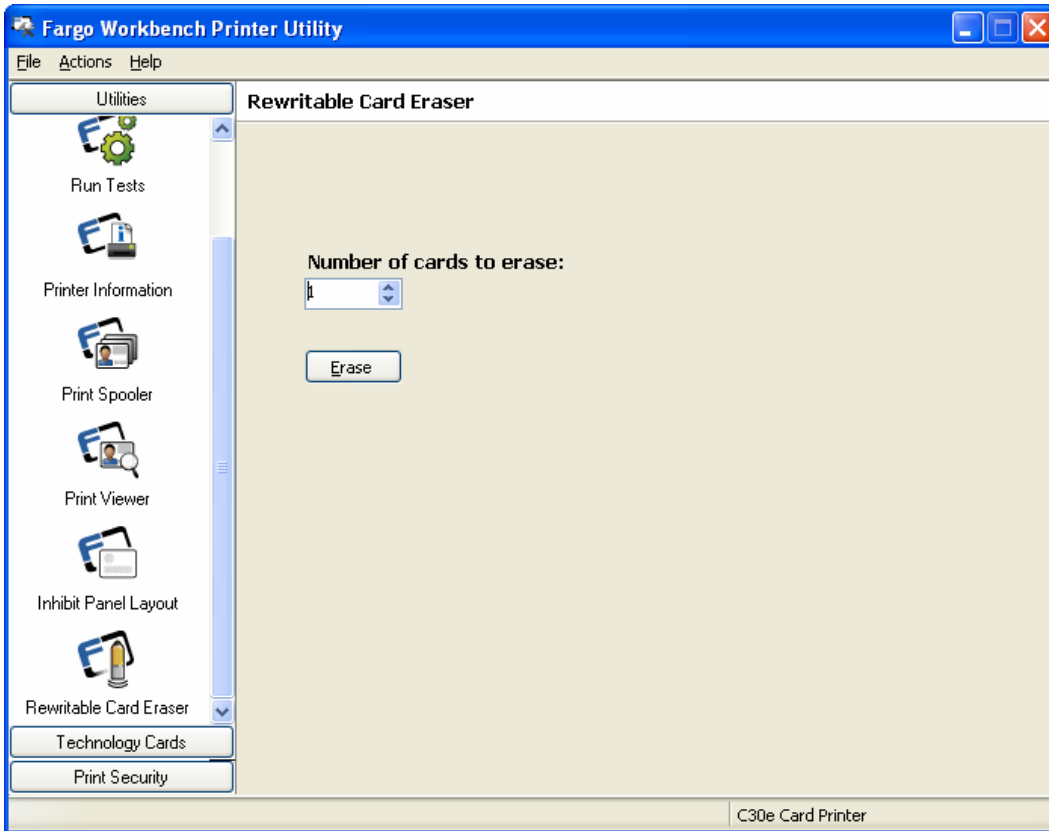

## Using the Erase Intensity Option (DTC400e/C30e)

Step	Procedure
1	<p>This setting is used only when the <b>None-Re-Writable</b> ribbon option is selecting in the driver Device Options tab. This option takes the place of the Overlay Heat (O) options in the driver when None RE-Writable is selected.</p> <ul style="list-style-type: none"> <li>Increasing this value will aide the erasing properties when using this process repeatedly on the same card. More intensity may be needed to fully erase these cards.</li> </ul>

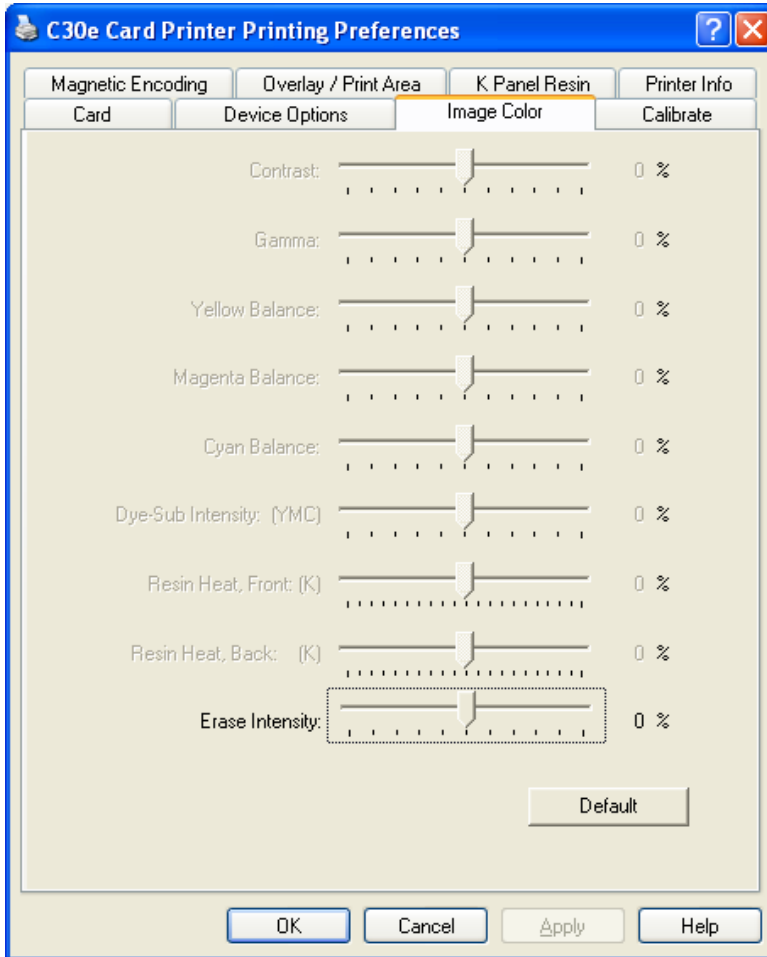

## Using the Erase Temperature Offset

Step	Procedure
1	<p>Adjust the Erase temperature for the rewriteable cards as needed.</p> <ul style="list-style-type: none"> <li>• Increase the <b>Current Setting</b> to cause more heat to be used in the erasing process.</li> </ul> <p><b>OR</b></p> <ul style="list-style-type: none"> <li>• Decrease the <b>Current Setting</b> to cause less heat to be used in the erasing process.</li> </ul> <p>(<b>Note:</b> Erase Temp Offset provides user ability to control the Printhead heat level when the Erase Operation is performed. Appropriate heat levels should be applied for the proper erase process. This setting should be adjusted for proper erasure)</p>

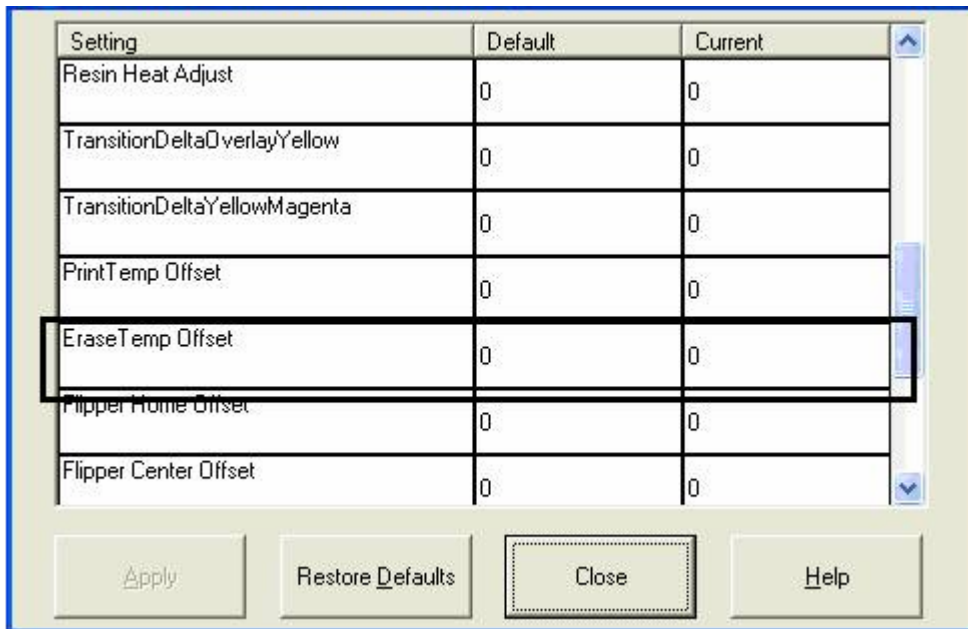

The image shows a software settings window with a table of parameters. The table has three columns: 'Setting', 'Default', and 'Current'. The 'EraseTemp Offset' row is highlighted with a thick black border. Below the table are four buttons: 'Apply', 'Restore Defaults', 'Close', and 'Help'. The 'Close' button is highlighted with a dotted border.



Setting	Default	Current
Resin Heat Adjust	0	0
TransitionDeltaOverlayYellow	0	0
TransitionDeltaYellowMagenta	0	0
PrintTemp Offset	0	0
EraseTemp Offset	0	0
Flipper Home Offset	0	0
Flipper Center Offset	0	0

Buttons: Apply, Restore Defaults, Close, Help

## Section 8: Cleaning

The Card Printer is built to require a minimum amount of maintenance. Nevertheless, there are a few procedures you can perform on a regular basis or as needed to ensure the best possible performance

### Safety Messages (review carefully)

Symbol	Critical Instructions for Safety purposes
<p><b>Danger:</b></p> 	<p><b>Failure to follow these installation guidelines can result in death or serious injury.</b></p> <p>Information that raises potential safety issues is indicated by a warning symbol (as shown to the left).</p> <ul style="list-style-type: none"> <li>• <b>To prevent personal injury</b>, refer to the following safety messages before performing an operation preceded by this symbol.</li> <li>• <b>To prevent personal injury</b>, always remove the power cord prior to performing repair procedures, unless otherwise specified.</li> <li>• <b>To prevent personal injury</b>, make sure only qualified personnel perform these procedures.</li> </ul>
<p><b>Caution:</b></p> 	<p><b>This device is electrostatically sensitive. It may be damaged if exposed to static electricity discharges.</b></p> <p>Information that raises potential electrostatic safety issues is indicated by a warning symbol (as shown to the left).</p> <ul style="list-style-type: none"> <li>• <b>To prevent equipment or media damage</b>, refer to the following safety messages before performing an operation preceded by this symbol.</li> <li>• <b>To prevent equipment or media damage</b>, observe all established Electrostatic Discharge (ESD) procedures while handling cables in or near the Circuit Board and Printhead Assemblies.</li> <li>• <b>To prevent equipment or media damage</b>, always wear an appropriate personal grounding device (e.g., a high quality wrist strap grounded to avoid potential damage).</li> <li>• <b>To prevent equipment or media damage</b>, always remove the Ribbon and Cards from the Printer before making any repairs, unless otherwise specified.</li> <li>• <b>To prevent equipment or media damage</b>, remove jewelry from fingers and hands, as well as thoroughly clean hands to remove oil and debris before working on the Printer.</li> </ul>



**DTC400e/C30e/M30e Card Printer/Encoders Cleaning Kit (Part Number 085976)**

**Caution:** As with any electronic device, internal components of the Printer, such as the Printhead, may be damaged if exposed to static electrical discharges. To avoid potential damage, always wear an appropriate personal grounding device, such as a wrist strap (with integral resistor) connected to an ESD ground.

**Supplies (included with the Cleaning Kit)**

This Cleaning Kit provides you with the specialized cleaning supplies and the required cleaning procedures for you to maintain your Fargo Persona C30e/M30e Card Printer/Encoders. The following cleaning procedures will require less than ten minutes. For more thorough cleaning instructions, please refer to the Cleaning Section in the appropriate User Guide.

**Four (4) Printhead Cleaning Swabs** are pre-moistened with 99.99% isopropyl alcohol for cleaning your Printer's Printhead.

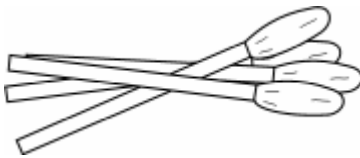

**Ten (10) Gauze Pads** are pre-moistened with 99.99% isopropyl alcohol for cleaning your Printer's interior and exterior.

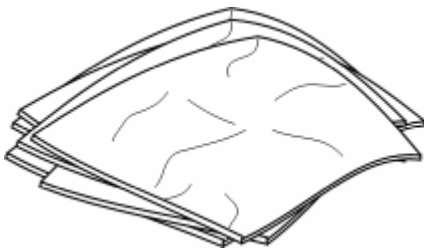

**Ten (10) Cleaning Cards** are provided with adhesive backing for cleaning your Printer's Platen and Card Feed Rollers.



## Cleaning the Printhead

Perform this procedure approximately every **1000 prints** to maintain a consistent print quality.

Step	Procedure
1	Open the Printer's Front Cover.
2	Remove the Print Ribbon.
3	Squeeze the <b>Printhead Cleaning Swab</b> to saturate the tip of the swab with alcohol.
4	Use the Printhead Cleaning Swab to gently rub back and forth over the entire length of the Printhead (3 to 4 times).
5	Once the Printhead is completely dry, replace the Ribbon and close the Front Cover.

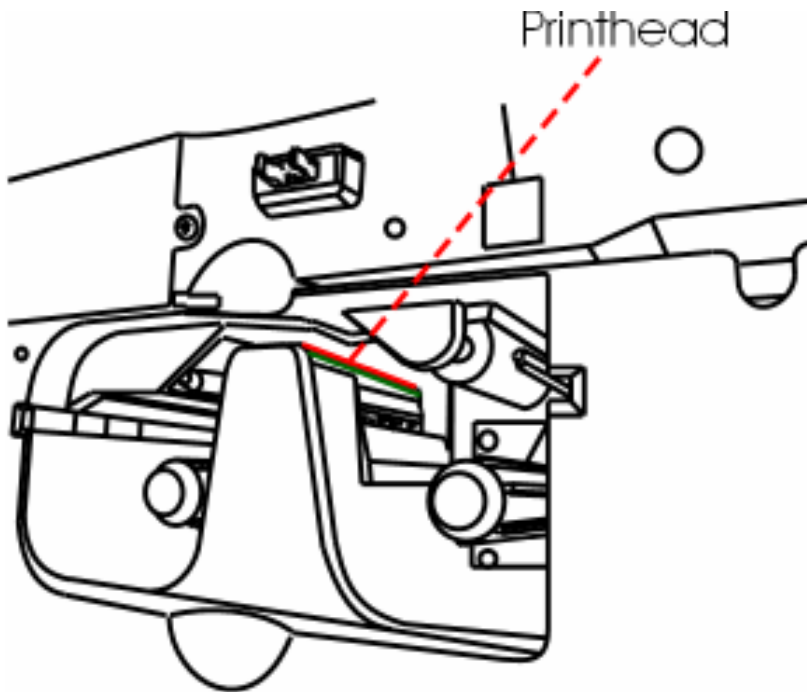

## Cleaning the Platen and the Card Feed Rollers

Perform this procedure approximately every **1000 prints** to maintain a consistent print quality. (**Note:** The Card Feed Rollers move the card throughout the print process. Rollers should be kept clean to prevent card jams and card contamination. This cleaning process will ultimately lead to better print quality and extended Printhead life.)

Step	Procedure
1	Open the Printer's Front Cover and remove the Print Ribbon.

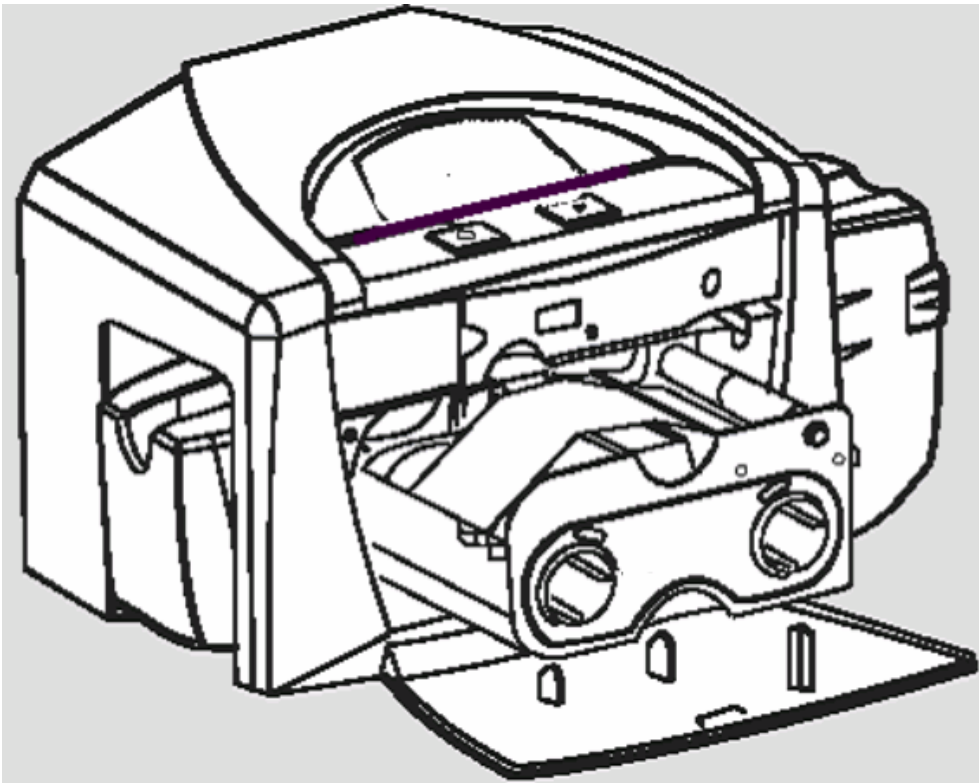

2	Remove all the cards from the Printer's Input Hopper.
3	Use the <b>Cleaning Card</b> from the Printer's <b>Cleaning Kit</b> and remove the adhesive backing from both sides of the card. ( <b>Note:</b> If your Printer has a Magnetic Encoder installed, be sure to leave the small Liner Strip on top of the <b>Cleaning Card</b> in place. This small strip is needed to protect the Magnetic Head from the adhesives on the <b>Cleaning Card</b> .)



4	Insert the <b>Cleaning Card</b> into the Single Feed Card Slot until the card stops. ( <b>Note:</b> If your Printer is equipped with a Magnetic Encoder, you must insert the <b>Cleaning Card</b> with the printed side up and with the small Liner Strip towards the front of the Printer.)
---	--

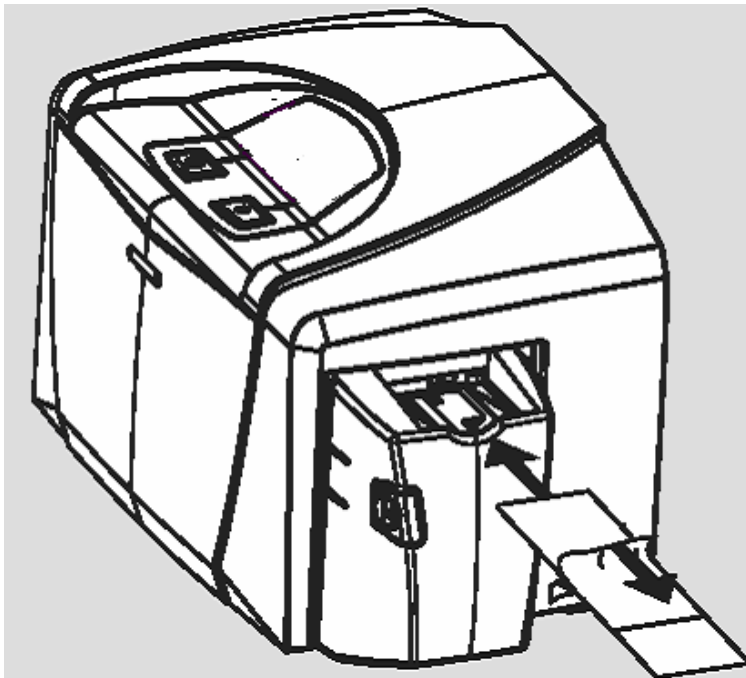

5	From your computer, open the Printer Driver and select Printing Preferences.
6	Click on the <b>Clean Printer</b> button.
7	Click on the <b>Clean</b> button. ( <b>Note:</b> The Printer will pull in the <b>Cleaning Card</b> . The Printer will then perform an automated cleaning procedure. This procedure is designed to thoroughly clean the Platen and the Card Feed Rollers inside the Printer.)



## Cleaning the Printer's Interior

Periodically, use a **Cleaning Pad** from the Printer's **Cleaning Kit** to remove dust and other contaminants from inside the Printer. (**Note:** Dust and other particles may accumulate inside the Printer with continued usage. This can cause spots or specks to appear on the printed cards.)

## Cleaning the Printer's Exterior

Clean it only with a **Cleaning Pad** from the Printer's **Cleaning Kit**. (**Note:** The Printer has a durable casing that should retain its luster and appearance for many years.)

## Packing the Card Printer

The purpose of this section to provide the User with a specific packing procedure for this Card Printer.

Follow this instruction to pack the Card Printer for transport.



<b>Step</b>	<b>Procedure</b>
1	Clean the inside of the Printer with compressed air.
2	Wipe it down with a lint-free cloth.
3	Clean the Printhead with an alcohol swab.
4	Pack the Printer in the original carton and packing materials.
5	Ensure to enclose any necessary paperwork, test cards, etc.

# Section 9: Firmware Upgrades

## Requirements

- Windows 32 bit Operating System (2000/XP/2003) Vista (32 bit & 64 bit)
- Internet Access

## Safety Messages (review carefully)

Symbol	Critical Procedures for Safety purposes
<p><b>Danger:</b></p> 	<p><b>Failure to follow these installation guidelines can result in death or serious injury.</b></p> <p>Information that raises potential safety issues is indicated by a warning symbol (as shown to the below).</p> <ul style="list-style-type: none"> <li>• <b>To prevent personal injury</b>, refer to the following safety messages before performing an operation preceded by this symbol.</li> <li>• <b>To prevent personal injury</b>, always remove the power cord prior to performing repair procedures, unless otherwise specified.</li> <li>• <b>To prevent personal injury</b>, make sure only qualified personnel perform these procedures.</li> </ul>
<p><b>Caution:</b></p> 	<p><b>This device is electrostatically sensitive. It may be damaged if exposed to static electricity discharges.</b></p> <p>Information that raises potential electrostatic safety issues is indicated by a warning symbol (as shown to the below).</p> <ul style="list-style-type: none"> <li>• <b>To prevent equipment or media damage</b>, refer to the following safety messages before performing an operation preceded by this symbol.</li> <li>• <b>To prevent equipment or media damage</b>, observe all established Electrostatic Discharge (ESD) procedures while handling cables in or near the Circuit Board and Printhead Assemblies.</li> <li>• <b>To prevent equipment or media damage</b>, always wear an appropriate personal grounding device (e.g., a high quality wrist strap grounded to avoid potential damage).</li> <li>• <b>To prevent equipment or media damage</b>, always remove the Ribbon and Cards from the Printer before making any repairs, unless otherwise specified.</li> <li>• <b>To prevent equipment or media damage</b>, remove jewelry from fingers and hands, as well as thoroughly clean hands to remove oil and debris before working on the Printer.</li> </ul>

## Upgrade the Printer Firmware

Step	Procedure
1	Download the current firmware from: <a href="http://www.fargosupport.com">www.fargosupport.com</a> Save this file to a folder to be retrieved later. ( <b>Note:</b> This is a zip file so unzip this to the same folder.)
2	Open the Fargo Workbench Printer Utility by clicking on the <b>Diagnostics</b> button on the Card tab of the Printing Preferences.

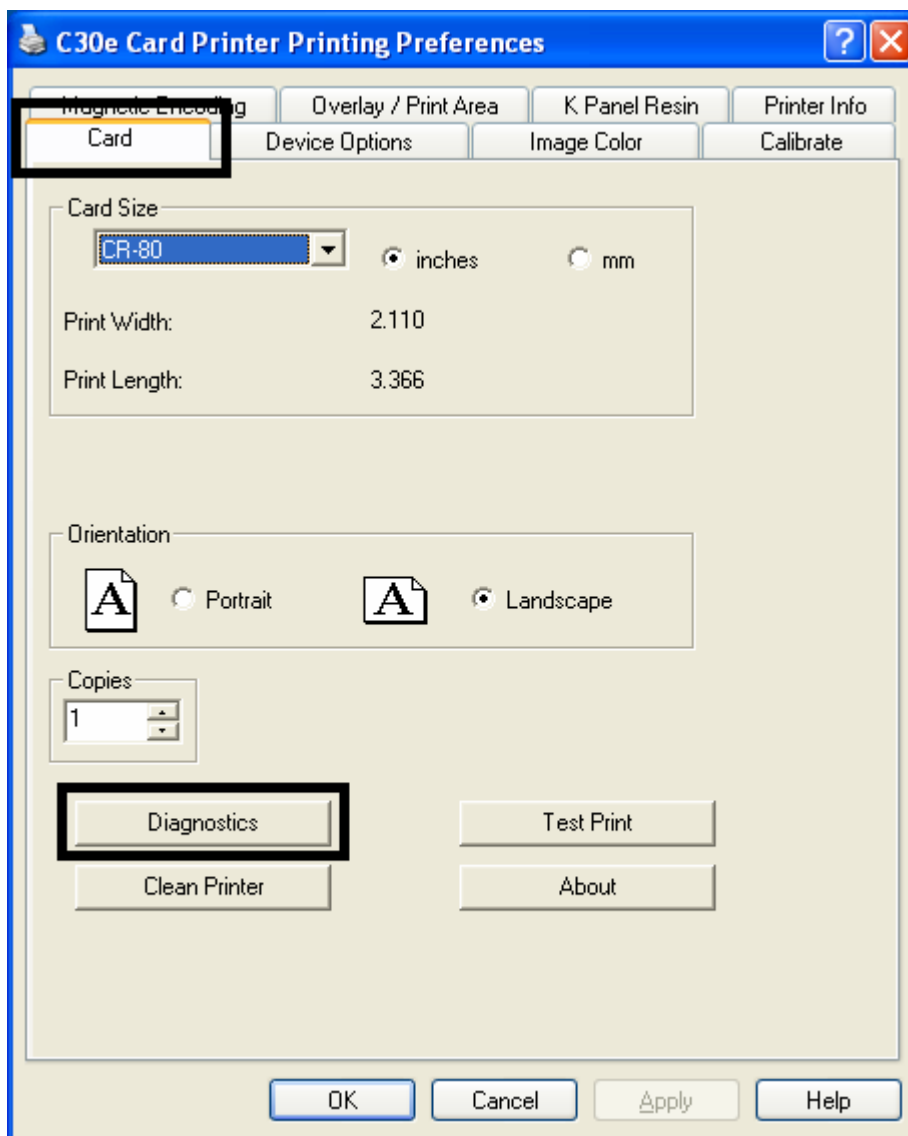

3	a. Open the Print Spooler.
---	----------------------------



	b. Select <b>File to Print</b> and browse to find the new Firmware file saved on the computer. ( <b>Note:</b> This is an .frm file.)
--	--

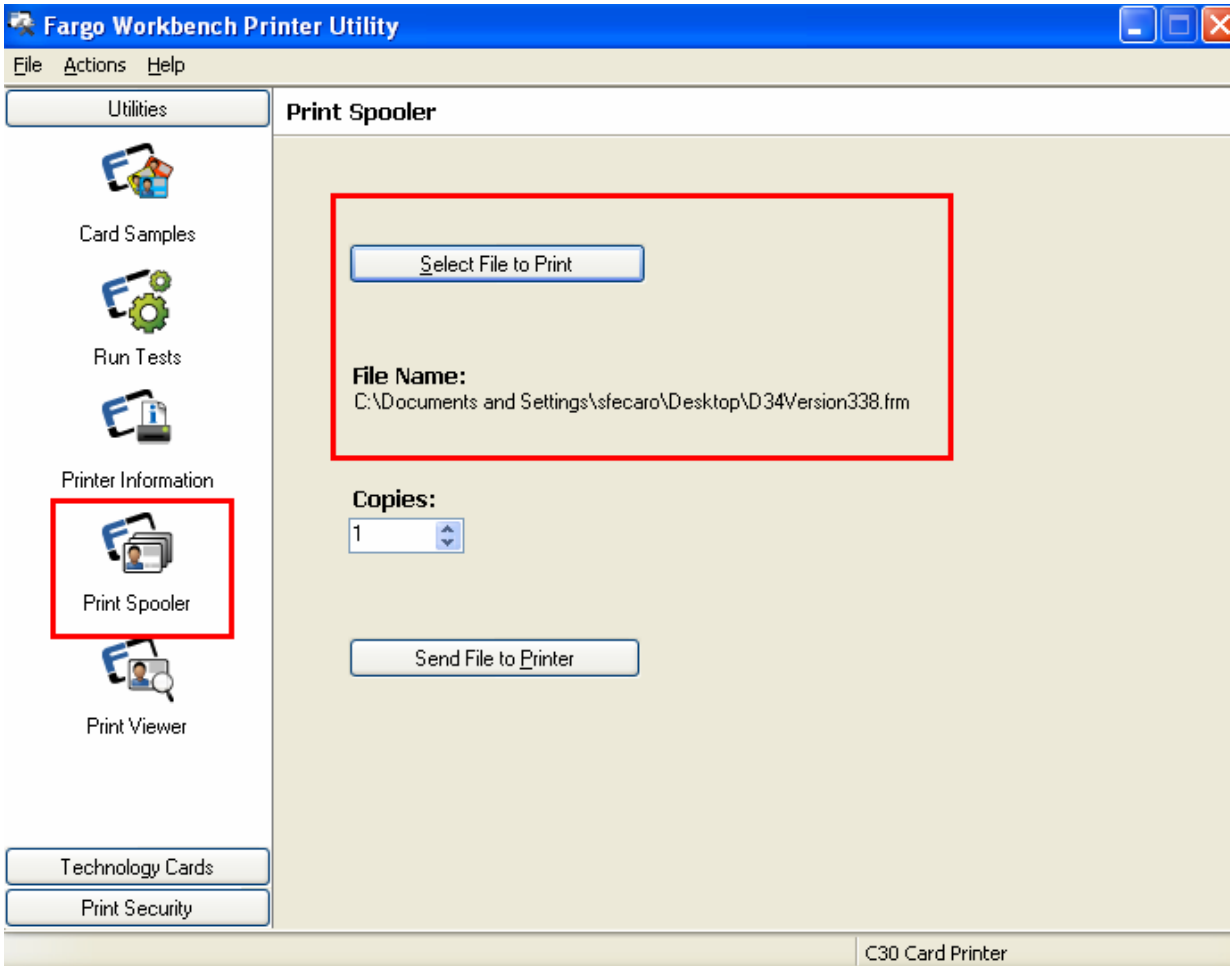

4	a. Prepare the printer for the Firmware upgrade. b. Press and hold down the <b>Power</b> and <b>Pause</b> buttons on the Printer (while you plug in the power). ( <b>Note:</b> Both lights will blink slowly.)
5	From the Workbench screen, select <b>Send File To Printer</b> . ( <b>Note:</b> Both lights will flash very fast while the Firmware is going through the update process.)
6	Upon successful completion of the Firmware Update, the Printer will restart. ( <b>Note:</b> The lights will remain solid.)
7	The procedure is now completed.



# Section 10: Fargo Technical Support

The purpose of this section to provide the User with an efficient, step-by-step procedure to be used when contacting Fargo Technical Support as needed for this Card Printer.

## Contacting Fargo Technical Support

Step	Procedure
1	<p>Refer to Section 3: <a href="#">General Troubleshooting</a></p> <p>Contact the Fargo Technical Support Group by phone at (952) 941-0050 or by fax at (952) 946-8492 for additional technical assistance.</p> <p><b>OR</b></p> <p>Contact Fargo Technical Support via the Web: <a href="http://www.fargosupport.com">http://www.fargosupport.com</a></p>
2	<p>Position a phone near the Printer and Computer so Fargo technicians can help to troubleshoot the Printer(s).</p>
3	<p>Please have a self-test and a sample card ready when calling Fargo Technical Support.</p>

## Reading the Serial Numbers on a Fargo Printer

The purpose of this section is to provide updated instructions for reading serial numbers on a Fargo Printer.

### Finding out when a Fargo Card Printer was manufactured

You can determine when your card Printer was manufactured by reading directly from the serial number (affixed to your card Printer).

1. **Year Built:** The first two digits in the serial number indicate the year that the Printer was manufactured.
2. **Week Built:** The second two digits indicate the week.
3. **Numeric Order:** The last four digits indicate the sequence number for the numeric order in which the Printers were built.

### Reviewing Example No. 1: Serial Number A9020001

1. A9020001: The first two digits in the serial number indicate the year the Printer was built (e.g., the digits 80 indicate the year 2009).
2. A9020001: The third and fourth digits in the serial number indicate the week the Printer was built (e.g., the digit 2 indicates week 2 of that year).
3. A9020001: The last four digits indicate the sequence number for the numeric order in which the Printers were built.

# Section 11: Glossary of Terms

Term	Definition
24-bit color	A color depth for an image that uses 8 bits for each color (red, blue, green) combining the possible 256 shades to provide a color depth of 16.7 million colors.
AC - Alternating Current	An electrical current that reverses its direction at regular intervals (typically 50 - 60 times a second).
Access Card	The card for the SmartGuard security system. A card with embedded electronics that can be removed from the Printer, locking the Printer and preventing unauthorized use.
Adhesion	The firm attachment of a material to the card surface, confirmed by using the Tape Test -pulling an applied piece of adhesive tape (Scotch 600 or equivalent) off the card at 1 sec/in to see if any material is pulled off by the tape.
Algebraic	A type of color matching that takes the color value of pixels and applies them to an algebraic equation to adjust the levels of hue, saturation and brightness.
ANSI (American National Standards Institute)	The United States Representative to ISO, providing standardization for U.S. Manufacturers prior or in addition, to acceptance by ISO.
AS400	An IBM operating system running on a main frame. DTC500 Fargo Printers are built with fonts saved in the Printer memory so users of AS400 can write escape codes and print from the Printer.
ASCII (American Standard Code for Information Interchange)	A standard for processing information in computer processors. An 8-bit character set of 255 decimal numbers, each assigned to numbers, letters, punctuation and special characters.
AT	Refers to an IBM standard in early computing with regard to the chipset and function of the parallel port, set up in the BIOS.
B (Black)	Black Dye-Sublimation panels are distinguished from the black panel using resin by the use of B for dye sub black. K denotes resin black.
Barcodes	A series of alternating black and white stripes, of varying widths (each character denoted by a set number and width of black stripes) that allows characters to be optically read by a computer.
Batch print	A file sent down from the computer that contains commands to print

	a number of cards, sequentially.
Battery Back-up	A power supply that can keep AC electronic equipment running for a short time when power is interrupted, allowing enough time for the user to save data and close the machine properly.
Bi-directional	A communication standard that allows two way data transfer between PC and Printer.
BIOS (Basic Input/Output System)	The part of the operating system in a computer that handles communication between the PC mainboard and its peripherals. Typically residing in chip-based, non-volatile memory.
Bit	An abbreviation for binary digital. Each bit is an element of information that can have two states: off and on.
Bit map	A graphic produced by an array of pixel elements with the color hue, brightness and saturation information stored in bits. The more bits, the more values and thus the greater variety. 1 bit color is black and white, 8-bit color produces 256 shades of gray and 24-bit color can produce 16.7 million colors.
Board	A term used for the circuit board, a hard mylar plate made of many layers, that holds the electronic circuit elements and wire traces.
Boot-up	A series of operations that the Printer runs through when power is first applied including a series of initializing, status testing and a diagnostics program to ensure a ready state.
Buffer	A block of memory, in the Printer or PC, that holds print files until the processor is ready to print them.
Cable	A set of conductors wrapped together and often concealed within insulation, used for signal transfer from one device to another, with connectors on either end that allows the cable to be removed.
Cache	A type of memory buffer to store data temporarily, used to hold information that is most often exchanged between controller and peripheral, to expedite data transfer.
Calibrating	A procedure to adjust an electro-mechanical device so that it operates within established parameters.
Cleaning Roller	High tack Rollers positioned just after the input Hopper to lift debris off the card as it rolls over it. A clean card surface improves print quality.
CD (Compact Disc)	A 4.75 inch (12 cm) optical disk that stores data, written too and read from using a laser.
DMA (Direct Memory	Channels designated within the Windows operating environment

Access)	that are used for dedicated high-speed communication between the PC and the Printer port.
Centronics	A parallel communications interface that has become the standard for connections to Printers, designed by the Centronics Corp.
Coercivity	The property of a Magnetic Stripe that indicates the amount of force needed before magnetic saturation, measured in Oersted (Oe).
Color matching	The process of adjusting color hue, saturation and brightness, to duplicate a desired color. An algorithm within the Driver, which adjusts the color balance and provides output with the desired color, automates this process.
Compressed air	Air stored in a tank or produced by an aerosol can, delivered by through nozzle at a high speed. Used in the Printer to blow out debris.
Contrast	The degree of difference in luminance of two areas.
Control panel	The panel on the Printer from which the user can control Printer functions. The Printer is usually composed of the control buttons and an LED or LCD display.
CR-79	A card dimension standard of 2.0625" L X 3.3125" W (+/-0.002" W, +/-0.005" L) or 52.400 X 84.150 mm.
CR-80	A card dimension standard of 2.125" X 3.370" (+/-0.002" W, +/-0.005" L) or 53.975 X 85.598 mm.
CR-90	A card dimension standard of 2.375" X 3.625" (+/-0.002" W, +/-0.005" L) or 60.325 X 92.075 mm.
CR-100	A card dimension standard of 2.625" X 3.875" (+/-0.002" W, +/-0.005" L) or 66.675 X 98.425 mm.
Cursor	The marker in the LCD Display Window that indicates the active selection.
Darkness	A reference to color saturation.
DB-9	A 9 pin, D-shaped connector, typically used in serial port interfaces.
DC Motor	A Motor that works on DC with continuous motion.
DC (Direct Current)	Electronic flow that is unidirectional, flowing from the positive (+) to negative (-) of a power source.
Default	A setting or parameter that comes preset from the factory in Driver or firmware. Performance parameters may be customized in the Driver, but can be reset to the factory values usually through the

	push of the default button. The default values for the firmware are usually denoted on a label attached to the Printer.
Defrag	Abbreviation for defragmenting. The process of reformatting data on a hard Drive so that it uses space more efficiently.
DIP switches (Dual In-line Package Switches)	A small array of mechanical switches installed on the board that can be configured to change Printer operations including providing a variety of self-tests.
Direct-to-Card (DTC) Printing	The Direct-to-Card printing process prints digital images directly onto any plastic card with a smooth, clean, glossy PVC surface.
Dither	A system of distributing dots to control the hue, brightness and/or saturation. In monochrome printing, this controls the brightness. In color printing, dithering can supply a larger color gamut than non-dithering. In the Driver, dither modes can be selected to provide better image quality depending on the type of image to be printed.
Dongle	A peripheral that attaches to a port to act as a key for an installed application. The PC is able to run that application only when the dongle is installed. Typically, it works as a pass-through device and is connected in serial to the parallel cable.
Dot	The smallest unit of an image that the Printer is able to produce. The smaller the dot, see dot pitch, the sharper the image.
Dot pitch	A measurement of image sharpness denoting the width of the dots that make up a pixel. The smaller the pitch, the sharper the image.
Download	The transfer of a data file from one device to the other over a network or cable, typically from the Internet to a PC.
DPI (Dot Per Inch)	A measurement of the Printer resolution indicating how many dots a Printer can produce in a linear inch.
DRAM (Dynamic Random Access Memory)	A microchip based volatile memory storage device. The Printer uses this to buffer a print job, transferred from the PC, until the Printer controller is able to process the packet.
Driver	Software utility installed in Windows, that interfaces an application to rasterize image data and include command codes so the Printer can process the file.
Duplex Printing	Printing on the front and the back of the card.
Dwell Time	The speed at which the card moves across the lam Roller, measured in seconds/inch (secs/in). This may be adjusted in the Driver to ensure adhesion and card flatness.



Dye Migration	The diffusion of dye out of the card surface and into another receptive surface, such as a vinyl pouch card holder, resulting in a faded image.
Dye-Sublimation	Also called dye diffusion/thermal transfer, it is the process of heating a dye suspended in a cellulous substrate until the dye can flow, diffusing into the dye receptive surface of the card or InTM. This produces the image in the surface of the card.
E-card	An abbreviation for electronic card. A generic term used to reference any card with built-in electronic devices such as smart cards or prox cards.
E-card Docking Station	The device in the Printer that accepts smart cards with an ISO smart card contact station. This allows the user to write to the smart card chip with a standard RS-232 interface in the back of the Printer or with the optional built-in encoder.
Edge-to-Edge	Refers to the maximum printable area on a card resulting in printed cards with virtually no border.
ECP Mode (Enhanced Capabilities Port Mode)	A type of parallel port mode, developed by Microsoft, to increase the port throughput and improve performance.
EE Memory	An abbreviation for EEPROM.
EEPROM (Electrically Erasable Programmable Read Only Memory)	A microchip based non-volatile memory storage device that can be rewritten in the field. The chip can hold new values as the Printer adapts its operational parameters.
Encoder (smart card)	An electro-mechanical interface to transfer data from the PC to a chip or Magnetic Stripe built into the card.
Encoder (wheel)	An electromechanical device, attached to a shaft that detects the change in rotational position, incremented to count ticks per revolution. The Printer's encoder wheel both detects motion and measures the amount of rotation in the movement of the Ribbon.
Engine	A generic term for a collection of systems and mechanisms that is dedicated to executing a specific function. A Printer that also laminates would have both a print engine and a lamination engine.
EOF (End Of Form)	The trailing edge of the card, detected to indicate when the Printer should stop printing.
EPP (Enhanced Parallel Port)	A type of parallel port mode, developed by Intel, to increase the port throughput.

EPROM (Electronically Programmable Read Only Memory)	A microchip based non-volatile memory storage device that cannot be rewritten in the field. Firmware for many Fargo Printers is stored on these chips and so a change of the chip is necessary for an upgrade.
Escape sequence	A string or control character that indicates to the processor that what follows is a command and not data.
ESD (ElectroStatic Discharge)	The discharge of static electricity (high voltage, low current) that can damage electronic devices.
Ethernet	A system of networking a series of computers for the sharing of data or peripherals.
Film	A thin flexible transparent sheet used to carry dye-impregnated material or resin to be transferred to the card.
Firmware	The instruction set, stored in chip memory, inside the Printer that controls functional and operational data. Some models require a chip change for updates; some firmware can be changed by reprogramming from the PC.
Flash Memory	A microchip based non-volatile memory device that holds its data when power is removed. This allows for field reprogramming of the Printer commands, such as Printer firmware upgrades, without the necessity of changing chips.
Font	A character set similar in style and form. Fonts can be graphical or mathematical constructs, represented by a series of dots or an assembly of curves and lines.
FPGA (Field Programmable Gate Array)	A microchip with configurable logic circuits installed that is programmed to act as the Printer's central processor.
Full bleed	Printing that covers the entire card surface.
Gamma	The degree of contrast of an image or the display of a monitor determined by the slope of a characteristic curve relating optical density to relative log exposure.
Glossy / Matte	A smooth polished surface in comparison to a rougher matte surface. Fargo matte cards have a surface index (Ra) of approximately 65 microinches while glossy have a Ra = 3.
Glossy PVC	A card made of PVC with a smooth polished surface (Surface roughness of approximately 0 - 10 micro-inches). This is required for direct to card dye-sublimation printing.
Graphical Device	A Windows standard for protocol between Drivers and

Interface (GDI)	applications and the Windows interface. An application uses a Driver to rasterize the data in the format necessary for the Printer but also for the Windows interface to execute the print commands.
Gray Scale	A graduation through the various brightness levels from white to black.
Halftoning	A process in monochrome printing that simulates continuous tone by using changes to the distribution of single dots. Increasing the number of dots in a given area increases the darkness even though the individual dots stay the same size.
Hard Drive	A high capacity storage device in a PC consisting of non-removable magnetically encodable platters.
Hardware	Physical components of a system such as the Printer, the PC, the power supply.
HDP (High Definition Printing™)	The High-Definition Printing process prints full-color images onto clear HDP transfer film (InTM). The HDP film is then fused to the card through heat and pressure via a heated Roller. The Printhead is capable of 256 shades with a sharper print and better color match.
Head	Abbreviation for Printhead.
Heat sink	A device used to dissipate heat into the ambient.
Heat Seal	A resinous film transferred by the Printhead onto the back of an HDP intermediate transfer film to facilitate adhesion.
HiCo (High Coercivity)	The coercivity value of magnetic media between 2500 - 4000 Oe (ISO 7811-6). Fargo's High Coercivity encodes at 2750 Oe.
HTML (HyperText Markup Language)	A standard protocol used to format text files for use in a browser or on the Internet.
HTTP (HyperText Transfer Protocol)	A standard protocol by which computers can transfer data, compatible through multiple platforms.
IC (Integrated Circuit)	An electronic device that contains many individual circuits interconnected and placed within a discrete package.
ID (Identification)	An abbreviation for identification.
IEEE 1284 (Institute of Electrical and Electronics Engineers 1284)	A standard method of signaling for a bi-directional parallel interface on personal computers. To ensure proper Printer communications and image output, Fargo recommends a parallel interface cable that complies with this specification.

Image	A collection of pictures or graphical elements that compose the visual features on a card. Also refers to the digital representation.
Input	Any data or material being transferred to the Printer.
Input Hopper	The area of the Printer that stores the blank cards, ready to print.
Intermediate Transfer Media (InTM)	A thin flexible material coated with a resin material into which the dye is transferred from the Ribbon by the Printhead. The film is then transferred to the card surface by the hot lamination Roller.
ISO	For the Greek, "iso", meaning same. Used to represent data from the International Organization for Standardization.
JIS II (Japanese Industrial Standard)	The standard for encoding to a Magnetic Stripe provided by the Japan Standards Association. The single track is as wide as ISO tracks 1 and 2 combined and in the same approximate location as those tracks but on the front of the card. The coercivity level is 600 Oe.
K Panel	An area of a multicolored Ribbon (e.g., YMCK) that contains black resin for transfer to the card surface. Also used in reference to the application of preference to items printed on the card - those using the black panel in lieu of a process (YMC) black.
Lamination	The application of a film or resinous substance, fused by heat and pressure, to the surface of a card.
LAN (Local Area Network)	An array of several computers connected through a series of data transfer cables for the sharing of data and peripherals.
Landscape	A document layout that is viewed with the document's long axis in a horizontal orientation.
LCD (Liquid Crystal Display)	A device that contains a liquid crystal between two pieces of polarized film through which reflected or ambient light can pass. When a current is applied, the liquid's polarity changes and blocks the passage of the light resulting in an opaque area of the display. The areas are arrayed to form characters.
LED (Light Emitting Diode)	A semiconductor that emits light when a current is applied.
Media	A generic reference to anything onto which the Printer can transfer an image including cards, Ribbon and film.
LoCo (Low Coercivity)	The coercivity value of magnetic media between 250 - 600 Oe (ISO 7811-2). Fargo's Low Coercivity encodes at 300 Oe.
LPT Port (Line	The system abbreviation for a PC's parallel Printer port.

Printer Port)	
Magnetic encoding	The process of orienting successive magnetic bits to produce a serial data string.
Magnetic stripe	An area of the card with an applied or impregnated ferrous material that may hold encoded data through a series of prescribed polarity changes.
Magnetic Track	An area of a magnetic strip running the length of the card, with a given width and position, constitutes a track. This is the area dedicated to one data string, restricted to specific rules of format. ISO Standards specify three magnetic tracks on the back of a card. The JIS standard specifies one track on the front.
Magnetic Verify	A process to confirm proper magnetic encoding. After encoding, the information is read off back and compared to the intended string.
MB (Megabyte)	A unit of storage that equals 1,048,576 bytes.
Medium Coercivity	The coercivity value of magnetic media is 600 Oe (ISO 7811-2).
Memory	A generic term for any device that stores digital information using magnetic media or digital chip storage device.
Menu	A descriptive list of headings above nested functions that aid navigation to a specific operation. These are found in computer applications, with the heading at the top of a subset of like functions. They are also on the Printer LCD control panel.
Monochrome	An image composed of a single color.
Network	A series of computers connected by data transfer cable for communication and sharing of functions and peripherals.
Oersted (Oe)	The unit of magnetic field strength named after Dutch scientist Hans Christian Oersted who found the science of electromagnetism.
Offset	The prescribed distance between a reference point and the target point. The offset in card printing may refer to the position of the image relative to the leading edge or the distance of the start of magnetic encoding from the leading edge of the card.
O-Ring	A rubber ring used as a belt in several media driving applications.
OS (Operating System)	The instructions installed on the computer hard Drive that run the computer's operations and applications. The Driver used for any given OS will differ from other platforms. The correct version Driver must be loaded for the Printer to interface with the OS and

	the application to print.
Output	Any product of the Printer including card image, encoded data and lamination.
Output Hopper	The portion of the Printer that accepts the completed cards.
Overlay	A resin-like substance that is transferred by the Printhead to the card surface over a printed dye image to prevent image fading, increase abrasion durability and prevent dye migration.
Oversized Cards	Oversized cards are used for more efficient visual identification and are available in many non-standard sizes. The most popular sizes are CR-90 (3.63" x 2.37"/92mm x 60mm) and CR-100 (3.88" x 2.63"/98.5mm x 67mm).
Overlamine	Protective clear or holographic material to increase security and durability applied over the printed surface with a hot Roller.
(Thin Film) Overlamine	A 0.25-mil thick resin material that enhances card security and durability applied over the printed surface with a hot Roller. Available as clear or with embedded holographic-type security images.
Parallel	A method of data transfer in which serial data is divided into sections and sent simultaneously down parallel wires to speed transfer rate.
Parallel port	A communication socket on a device that allows for parallel data transfer.
PC (Personal Computer)	A stand-alone, programmable, electronic device that can store, retrieve and process data consisting of a CPU, mouse, keyboard and monitor.
PCB (Printed Circuit Board)	A solid, multi-layered plate on which electronic elements are attached, either through the board or on the surface.
Peel	The removal of a film or Ribbon from a card surface (at a perpendicular angle) to ensure proper transfer, then separation, from the card surface.
Peel-Off	A bar on the lamination section that holds the film at the correct position and provides proper peel angle.
Peripheral	Any device that is attached externally to a PC. These often share the same data cable or port as a Printer and may be the source of communication problems.

Pinch Roller	A free spinning (non-Driven) Roller that presses the card against the Drive Roller, on the opposite side, to ensure an adequate normal force for proper traction.
Pixel	Short for picture element. The smallest element of a graphic.
Platen	The hard rubber Roller that Drives the media through the Printer, providing support to the backside of the media during printing or laminating.
PET	Abbreviation for polyester terephthalate, often called polyester. Sheets of PET are laminated with sheets of PVC to produce thermal acceptance composite cards.
Port	A communication interface, serial or parallel, used for the transference of data.
PolyGuard Overlamine	A 1-mil or .6-mil thick polyester material that enhances card security and durability applied over the printed surface with a hot Roller. Available as clear or with embedded holographic-type security images.
Portrait	A document layout that is viewed with the document's long axis in a vertical orientation.
Potentiometer	An electronic resistor with a variable resistance value that can be mechanically set.
Print Driver	A software utility that serves as an interface between the Printer and the Windows GDI (Graphical Device Interface), making the Printer's functions available through the software application. It also provides the format information for the rasterizing of the print file including any necessary escape or function commands.
Print Job	A file of one or more cards for the Printer to print, including image data and Printer functions, transmitted through the parallel interface and at times stored temporarily in the print buffer and spooler.
Print Server	A device used to connect and control a Printer on a network.
Printhead	The device on a Printer that produces the image on the media.
PVC	Abbreviation for polyvinyl chloride, often called vinyl. PVC is the component of the 0.002" thick clear, dye receptive film on the surface of the identification card and is the primary component of the identification card cores.
Queue	A sequence of files or sets of data, awaiting transmission or processing.

Proximity ("Prox") Card	Proximity cards allow access and tracking utilizing contactless technology, usually by communicating through a built-in antenna.
Prox Card Encoder	The Fargo prox card encoder uses an HID ProxPoint® Plus reader mounted on the e-card docking station inside the Printer/encoder. The ProxPoint is a "read only" device producing a Wiegand signal that is converted to RS-232 using a Cypress Computer Systems CVT-2232. Application programs can read information from HID prox cards via a RS-232 signal through a dedicated DB-9 port on the outside of the Printer labeled "Prox."
RAM (Random Access Memory)	A storage device for digital information to be held temporarily, to facilitate processing.
Rasterize	The process of converting the elements of a graphic into a bitmap to be printed.
Reboot	Cycling the power to the Printer so that it resets and reinitializes.
Registration	The quality of the alignment of the separate primary-color images: YMCK.
Resident Font	A set of characters loaded into the Printer memory that can be programmed to print those characters on the card without rasterizing the image.
Resin	A semisolid material.
Resolution	The number of individual pixel elements in a graphic, taken over a given length, used to indicate the sharpness of the picture and the level of detail. The number of elements in the Printhead determines Fargo Printer resolution.
RFI (Radio Frequency Interference)	Electromagnetic waves radiated by poorly shielded cables or electronic devices that interferes with the operation or data transfer of another device.
RGB (Red/Green/Blue)	The three primary colors of the luminance or additive, model. Combinations of these three colors can produce practically all the colors of the spectrum that humans can detect. Computer monitors operate on an RGB model.
Ribbon	The dye impregnated film that is used for color printing.
Ribbon cable	Parallel wires held flat in a row by plastic insulation.
RibbonTraq	A Fargo Electronics method of placing bar code-like marks on the transition area between color panels. These marks are arranged for detection by a reflective Sensor array for the identification of Ribbon type and the Ribbon position.



RMA number (Return Merchandise Authorization number)	A number, acquired from Fargo Support, that authorizes the return of merchandise for repair or credit.
Roller	Elements of the Printer used for the transport of media consisting of a rotating steel shaft (for Ribbon) or a rotating steel shaft with a rubber cylinder installed at the shaft midpoint (for moving cards).
RS-232	An interface standard, established in 1969 by the Electronic Industries Association, regarding the connecting of computer peripherals.
Saturation	A measure of the degree of color, from gray, with the same brightness.
Self-test	A pre-determined print file used to confirm Printer operation typically sent from the Driver or stored in the Printer's memory.
Sensor	An electro-mechanical/electro-optical device used to indicate a change in state in the Printer such as when a card reaches a certain location.
Serial communications	The transfer of data, one bit at a time and in sequential order, using a single wire.
Serial interface	A sub D 9 pin input/output port on the Printer, used for serial communication with the PC for AS400 operating systems or for e card encoding.
SIMM (Single In-Line Memory Module)	An array of memory chips, attached to a printed circuit board that installs in a slot on the main board.
Simplex	Single-sided printing.
SmartGuard	An application from Fargo Electronics that allows users to prevent access to the Printer through the use of a personally encoded smart card.
SmartGuard™	SmartGuard is a Printer security option that uses a custom access card and a built-in reader to restrict Printer access. Only a valid access card can enable the Printer to print cards.
SmartShield™	This option allows the Printer to print custom, security images on the card that reflect under a black or UV light source.
Smart Card	Smart cards have an embedded computer circuit that contains either a memory chip or a microprocessor chip. There are several types of smart cards: Memory, Contact, Contactless, Hybrid (Twin), Combi (Dual Interface), Proximity and Vicinity.

Software	Instructions saved in computer memory that directs the computer to perform certain tasks and functions.
Spooler	A computer application that allows the spooling of print jobs.
Spooling	Rather than moving a print job directly to the Printer, the job is written to the disk so that the user can access the application faster while Windows takes care of printing in the background.
SS (Start Sentinel)	The character denoting the end of a magnetic data string.
Stacker	The device that moves the finished cards onto the output column ordering them "First In, First Out".
Stepper Motor	A Motor whose shaft turns in discrete steps, rather than continuously.
String	A sequence of characters that form a line of data.
Surface mount	A method of mounting circuit elements onto the surface of a circuit board, attached at solder pads, rather than through holes in the board.
Surge Protector	An electronic device, placed in serial to the Printer's power supply, that prevents damage to the Printer from electronic surges and electrical current that is outside of the normal parameters.
Switch box	An electromechanical device to which a user may connect several peripheral devices to the parallel port simultaneously, yet using the selector switch to designate the active port.
TAC	Thermal Acceptance Composite cards. Card stock produced by laminating sheets of PVC with sheets of PET for better thermal distortion resistance. Ultra III cards.
Temp file	A temporary file, generated automatically by Windows, to store the information for an active document. Windows should delete these files when the application is closed.
Test-print	A file stored in or generated through windows that is sent to the Printer to test basic functionality.
Thermistor	An electronic resistor on the Printhead with a resistance value that varies in proportion to the heat to which it is exposed.
Thermocouple	A device for measuring temperature using a junction of two wires of dissimilar metals that produce a voltage when heated that varies proportionally with the temperature.
Through-hole	A method of mounting circuit elements with the leads passing

	through holes in the circuit board and soldered on the opposite side.
Timeout	An interruption of a print job that occurs when a function is not completed in the time allotted by the operating system.
TOF (Top of Form)	The leading edge of the card, as it travels through the Printer.
Track	The area on a Magnetic stripe designated to contain the magnetic data string.
Troubleshooting	The process of investigating and determining the cause of a problem.
TrueType (TT)	A font format that produces each character using a mathematical equation, rather than a graphical representation, resulting in a much sharper, cleaner image.
UltraCard	The Fargo brand of card stock, recommended for use in Fargo Printers, with the necessary glossy surface and composed of PVC.
UltraCard III	The Fargo brand of card stock, recommended for use in Fargo Printers that laminate, with the necessary glossy surface and composed of PVC and PET to prevent heat distortion.
Update	The process of installing a new revision of software or firmware to implement new changes to the Printer's command codes and procedures.
UPS (Un-interruptible Power Supply)	An AC power supply, typically powered by batteries, which provides temporary power to the PC or Printer during an interruption of the supply voltage.
USB (Universal Serial Bus)	A 1.5M/sec (12Mbit/sec) serial communication interface that can support 127 separate devices consisting of 4 wires: power, ground, data in and data out.
Virtual Memory	A technique used by Windows when chip memory is exhausted, in which data is written to the hard to hold data temporarily and support Window's operations.
Wrinkle	The appearance in the card image of wavy or arched lines, either colored or clear, caused by improper film or Ribbon tension.
YMC	The designation of colored Ribbon by the panels of color in the order in which they are printed: Yellow (Y), Magenta (M), Cyan (C).
YMCK	The designation of colored Ribbon by the panels of color in the order in which they are printed: Yellow (Y), Magenta (M), Cyan

	(C), Black (K).
YMCKH	The designation of colored Ribbon by the panels of color in the order in which they are printed: Yellow (Y), Magenta (M), Cyan (C), Black (K), Heat Seal (H).
YMCKK	The designation of colored Ribbon by the panels of color in the order in which they are printed: Yellow (Y), Magenta (M), Cyan (C), Black (K), Black (K) (the second K is for backside, black only printing).
YMCKO	The designation of colored Ribbon by the panels of color in the order in which they are printed: Yellow (Y), Magenta (M), Cyan (C), Black (K), Overlay (O).
YMCKOK	The designation of colored Ribbon by the panels of color in the order in which they are printed: Yellow (Y), Magenta (M), Cyan (C), Black (K), Overlay (O), Black (K) (used for backside, black only printing).
YMCFKOK	The designation of colored Ribbon by the panels of color in the order in which they are printed: Yellow (Y), Magenta (M), Cyan (C), Fluorescing (F), Black (K), Overlay (O), Black (K) (used for backside, black only printing).