

Digital Storage Oscilloscope

GDS-3000 Series

USER MANUAL

GW INSTEK PART NO. 82DS-33040M01



ISO-9001 CERTIFIED MANUFACTURER

GW INSTEK

This manual contains proprietary information, which is protected by copyright. All rights are reserved. No part of this manual may be photocopied, reproduced or translated to another language without prior written consent of Good Will company.

The information in this manual was correct at the time of printing. However, Good Will continues to improve products and reserves the rights to change specification, equipment, and maintenance procedures at any time without notice.

Good Will Instrument Co., Ltd.
No. 7-1, Jhongsing Rd., Tucheng City, Taipei County 236, Taiwan.

Table of Contents

SAFETY INSTRUCTIONS	5
GETTING STARTED	11
GDS-3000 Series Overview	12
Appearance	17
Set Up	28
QUICK REFERENCE	37
Menu Tree / Operation Shortcuts	39
Default Settings	52
Built-in Help	55
MEASUREMENT	57
Basic Measurement	59
Cursor Measurement	77
Math Operation	83
Applications	88
Using Go_NoGo	90
Power Analysis	95
Serial Bus	96
CONFIGURATION	99
Acquisition	101
Display	108
Horizontal View	114
Vertical View (Channel)	119
Trigger	126
System Info / Language / Clock	143
SAVE/RECALL	147
File Format/Utility	148

Create/Edit file labels.....	152
Save	154
Recall	161
Reference Waveforms.....	166
FILE UTILITIES.....	169
PRINT OUT.....	177
REMOTE CONTROL CONFIG	181
Interface Configuration	182
MAINTENANCE	189
FAQ	195
APPENDIX	199
GDS-3000 Specifications.....	199
Probe Specifications	204
GDS-3000 Dimensions	205
Declaration of Conformity.....	206
INDEX.....	207

S SAFETY INSTRUCTIONS

This chapter contains important safety instructions that you must follow during operation and storage. Read the following before any operation to insure your safety and to keep the instrument in the best possible condition.

Safety Symbols

These safety symbols may appear in this manual or on the GDS-3000.



WARNING

Warning: Identifies conditions or practices that could result in injury or loss of life.



CAUTION

Caution: Identifies conditions or practices that could result in damage to the GDS-3000 or to other properties.



DANGER High Voltage



Attention Refer to the Manual



Protective Conductor Terminal



Earth (ground) Terminal



Do not dispose electronic equipment as unsorted municipal waste. Please use a separate collection facility or contact the supplier from which this instrument was purchased.

Safety Guidelines

General Guideline



CAUTION

- Make sure the BNC input voltage does not exceed 300V peak.
- Never connect a hazardous live voltage to the ground side of the BNC connectors. It might lead to fire and electric shock.
- Do not place any heavy object on the GDS-3000.
- Avoid severe impact or rough handling that leads to damaging the GDS-3000.
- Do not discharge static electricity to the GDS-3000.
- Use only mating connectors, not bare wires, for the terminals.
- Do not block the cooling fan opening.
- Do not perform measurement at a power source or building installation site (Note below).
- Do not disassemble the GDS-3000 unless you are qualified.

(Measurement categories) EN 61010-1:2001 specifies the measurement categories and their requirements as follows. the GDS-3000 falls under category II.

- Measurement category IV is for measurement performed at the source of low-voltage installation.
- Measurement category III is for measurement performed in the building installation.
- Measurement category II is for measurement performed on the circuits directly connected to the low voltage installation.
- Measurement category I is for measurements performed on circuits not directly connected to Mains.

Power Supply



WARNING

- AC Input voltage: 100 ~ 240V AC, 47 ~ 63Hz, auto selection. Power consumption: 96VA.
 - Connect the protective grounding conductor of the AC power cord to an earth ground, to avoid electrical shock.
-

**Cleaning the
GDS-3000**

- Disconnect the power cord before cleaning.
 - Use a soft cloth dampened in a solution of mild detergent and water. Do not spray any liquid.
 - Do not use chemical containing harsh material such as benzene, toluene, xylene, and acetone.
-

**Operation
Environment**

- Location: Indoor, no direct sunlight, dust free, almost non-conductive pollution (Note below)
- Relative Humidity: < 80%
- Altitude: < 2000m
- Temperature: 0°C to 50°C

(Pollution Degree) EN 61010-1:2001 specifies the pollution degrees and their requirements as follows. The GDS-3000 falls under degree 2.

Pollution refers to “addition of foreign matter, solid, liquid, or gaseous (ionized gases), that may produce a reduction of dielectric strength or surface resistivity”.

- Pollution degree 1: No pollution or only dry, non-conductive pollution occurs. The pollution has no influence.
 - Pollution degree 2: Normally only non-conductive pollution occurs. Occasionally, however, a temporary conductivity caused by condensation must be expected.
 - Pollution degree 3: Conductive pollution occurs, or dry, non-conductive pollution occurs which becomes conductive due to condensation which is expected. In such conditions, equipment is normally protected against exposure to direct sunlight, precipitation, and full wind pressure, but neither temperature nor humidity is controlled.
-

**Storage
environment**

- Location: Indoor
 - Temperature: -20°C to 70°C
-

Disposal

Do not dispose this instrument as unsorted municipal waste. Please use a separate collection facility or contact the supplier from which this instrument was purchased. Please make sure discarded electrical waste is properly recycled to reduce environmental impact.

Power cord for the United Kingdom

When using the oscilloscope in the United Kingdom, make sure the power cord meets the following safety instructions.

NOTE: This lead/appliance must only be wired by competent persons



WARNING: THIS APPLIANCE MUST BE EARTHED

IMPORTANT: The wires in this lead are coloured in accordance with the following code:

Green/ Yellow:	Earth
Blue:	Neutral
Brown:	Live (Phase)



As the colours of the wires in main leads may not correspond with the coloured marking identified in your plug/appliance, proceed as follows:

The wire which is coloured Green & Yellow must be connected to the Earth terminal marked with either the letter E, the earth symbol  or coloured Green/Green & Yellow.

The wire which is coloured Blue must be connected to the terminal which is marked with the letter N or coloured Blue or Black.

The wire which is coloured Brown must be connected to the terminal marked with the letter L or P or coloured Brown or Red.

If in doubt, consult the instructions provided with the equipment or contact the supplier.

This cable/appliance should be protected by a suitably rated and approved HBC mains fuse: refer to the rating information on the equipment and/or user instructions for details. As a guide, a cable of 0.75mm² should be protected by a 3A or 5A fuse. Larger conductors would normally require 13A types, depending on the connection method used.

Any exposed wiring from a cable, plug or connection that is engaged in a live socket is extremely hazardous. If a cable or plug is deemed hazardous, turn off the mains power and remove the cable, any fuses and fuse assemblies. All hazardous wiring must be immediately destroyed and replaced in accordance to the above standard.

G E T T I N G S T A R T E D

This chapter describes the GDS-3000 in a nutshell, including its main features and front / rear panel introduction. After going through the overview, follow the Set Up section to properly set up the oscilloscope for first time use. The Set Up section also includes a starter on how to use this manual effectively.



GDS-3000 Series Overview	12
Series lineup	12
Main Features	13
Accessories	14
Package Contents	16
Appearance	17
GDS-3554/3354/3254/3154 Front Panel	17
GDS-3352/3252/3152 Front Panel	17
Rear Panel	23
Display	25
Set Up	28
Tilt Stand	28
Power Up	29
First Time Use	30
How to Use This Manual	33

GDS-3000 Series Overview

Series lineup

The GDS-3000 series consists of 6 models, divided into 2-channel and 4-channel versions.

Model name	Frequency bandwidth	Input channels	Real-time Sampling Rate
GDS-3152	150MHz	2	2.5GSa/s
GDS-3252	250MHz	2	2.5GSa/s
GDS-3352	350MHz	2	5GSa/s
GDS-3154	150MHz	4	5GSa/s
GDS-3254	250MHz	4	5GSa/s
GDS-3354	350MHz	4	5GSa/s

The 2 channel and 4 channel models differ in the position of the horizontal controls, the math, reference and bus keys as well as the position of the EXT trigger.

2-Channel model

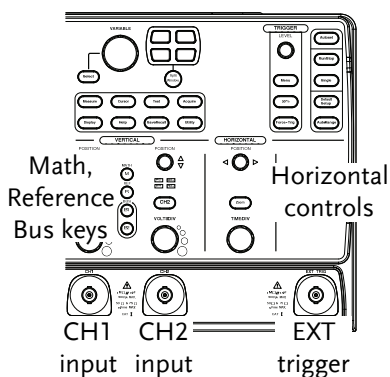

4-Channel model

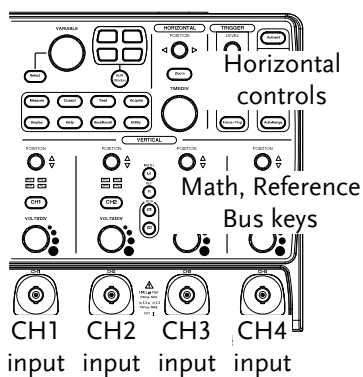

Main Features

Performance	<ul style="list-style-type: none">• High sampling rate: up to 5GSa/s real-time, 100GSa/s equivalent-time• Deep memory: 25k points record length• Minimum 2ns peak detection
Features	<ul style="list-style-type: none">• 2 and 4 channel models• Bandwidth up to 350 MHz• 5GSa/s (200ps resolution) real-time sampling rate• 100GSa/s equivalent sample rate• VPO waveform processing• Large 8" 800 x 600 high-resolution TFT LCD• Unique split window function• Flexible application modules• Three standard input impedances (50Ω/75Ω/1MΩ)• Optional power measurement functions are available for fast analysis of power quality tests• Optional analysis software for I²C, SPI and UART serial signal triggering and decoding• 2 and 4 channel models available up to 350 MHz• Large 8" color TFT LCD, supporting a large 8 x 10 graticule• On-screen Help• 64 MB internal flash memory.• FreeWave remote control software (free download)

- Interface
- USB host port: front and rear panel, for storage devices
 - USB slave port(Optional GPIB to USB), RS-232C port: for remote control
 - Calibration output
 - Go-No Go output
 - External trigger input
 - Ethernet port

Accessories

Standard Accessories	Part number	Description
	82DS-33040M01	User manual
	N/A region dependent	Power cord
Options	Option Number	Description
	DS3-PWR	Power analysis software
	DS3-SBD	Series Bus analysis software
	GPIB to USB adapter	GPIB Interface
Optional Accessories	Part number	Description
	GTC-001	Instrument cart, 470(W)x430(D)mm (U.S. type input socket)
	GTC-002	Instrument cart, 330(W)x430(D)mm (U.S. type input socket)
	GTL-110	test lead, BNC to BNC heads
	GTL-232	RS-232C cable, 9-pin Female to 9-pin female, Null modem for computer
	GTL-242	USB cable, USB2.0A-B type cable 4P

GDP-025	25MHz high voltage differential probe
GDP-050	50MHz high voltage differential probe
GDP-100	100MHz high voltage differential probe
GCP-530	50MHz/ 30A current probe
GCP-1030	100MHz/ 30A current probe
GCP-206P	Power supply for current probe (2 input channel)
GCP-425P	Power supply for current probe (4 input channel)
GTP-151R	Passive probe; 150 MHz,10X with readout
GTP-251R	Passive probe; 250 MHz,10X with readout
GTP-351R	Passive probe; 350 MHz,10X with readout

Driver	Name	Description
	dso_cdc.inf	USB driver LabVIEW driver

Package Contents

Check the contents before using the GDS-3000.

Opening the box

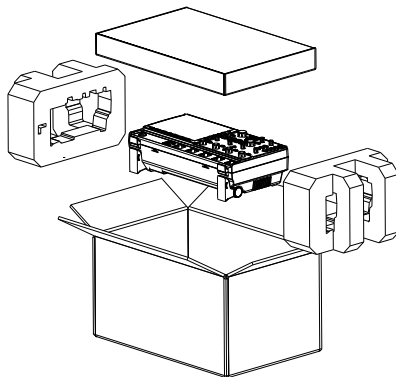

Contents

- Main unit
 - Probe set
 - GTP-151R for GDS-3152 / GDS-3154
 - GTP-251R for GDS-3252 / GDS-3254
 - GTP-351R for GDS-3352 / GDS-3354
 - Power cord
 - User manual (this document)
-

Note

- For detailed probe specifications, see page204.
- The programming manual, PC software, and USB driver are downloadable from the GWInstek website. Visit www.gwinstek.com, in the oscilloscope section.

Appearance

GDS-3554/3354/3254/3154 Front Panel

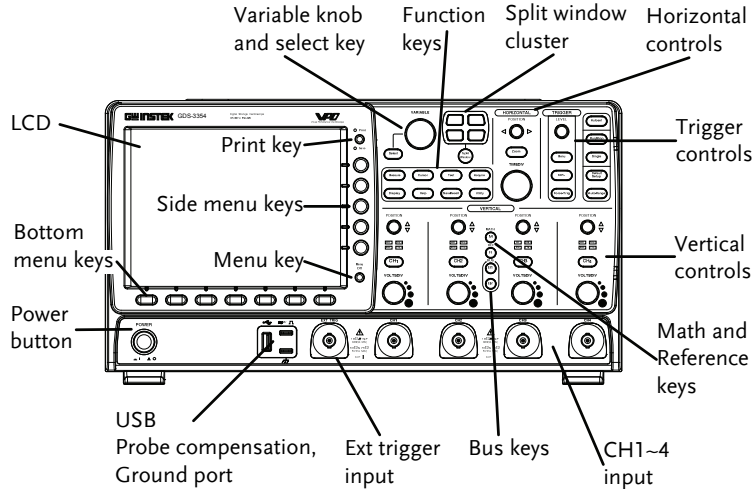

GDS-3352/3252/3152 Front Panel

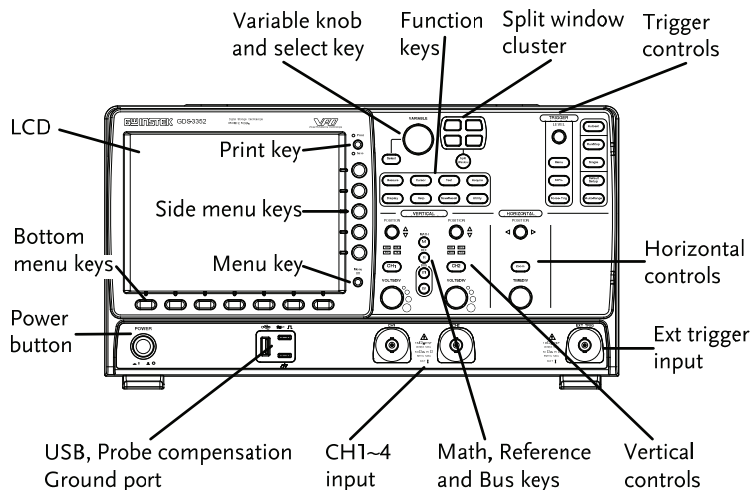

LCD display 8" SVGA TFT color LCD. 800 x 600 resolution, wide angle view display.

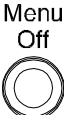
Menu Key  Use the Menu Off key to hide/show the onscreen menu system.

Side Menu keys The Side menu and Bottom menu keys are used to make selections from the soft-menus on the LCD user interface.

Bottom Menu keys

To choose menu items, use the 7 Bottom menu keys located on the bottom of the display panel.

To select a variable or option from a menu, use the Side menu keys on the side of the panel. See page 33 for details.

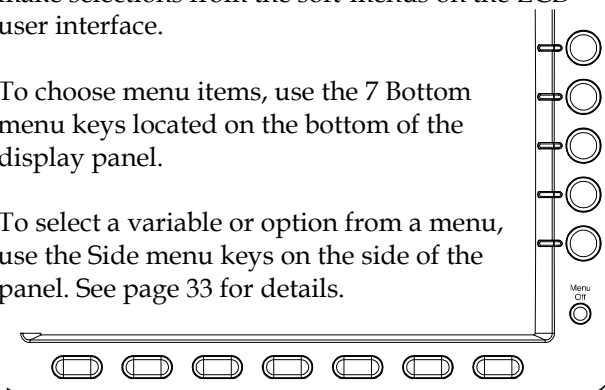

Print key  Print The print key is a quick save or quick print key, depending on its configuration. For more information see pages 156(save) or 178(print).

 Save

Variable knob and Select key  The Variable knob is used to increase/decrease values or to move between parameters.



The select key is used to make selections.

Split Window Cluster

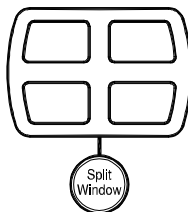

Use the Split Window key to cycle between single and split screen mode. To separate each channel into a split window, use one of the four windowed keys. For more details on windowing see page 67.

Horizontal Controls

The horizontal controls are used to change the position of the cursor, set the time base settings, and to zoom into the waveforms.

Horizontal Position



The Position knob is used to position the waveforms vertically on the display screen.

Zoom



Press Zoom in combination with the horizontal POSITION knob.

TIME/DIV



The Time/Div knob is used to change the horizontal scale.

Trigger controls

The trigger controls are used to control the trigger level and options.

Level Knob



Used to set the trigger level.

Trigger Menu key



Used to bring up the trigger menu.

50% key



















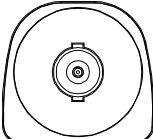



Sets the trigger level to the half way point (50%).

Force - Trig



Press to force an immediate trigger of the waveform.

Autoset		Press the Autoset key to automatically set the trigger, horizontal scale and vertical scale.
Run/Stop key		Press to Freeze (Stop) or continue (Run) signal acquisition (page62).
Single		Sets the acquisition mode to single triggering mode.
Default Setup		Resets the oscilloscope to default settings.
Auto-Range		Sets the oscilloscope range automatically.
Vertical POSITION	<p data-bbox="372 699 456 719">POSITION</p> 	Sets the vertical position of the waveform.
Channel Menu Key		Press the CH1~4 key to set the coupling and vertical scale of the corresponding channel.
VOLTS/DIV Knob	<p data-bbox="362 967 456 987">VOLTS/DIV</p> 	Sets the vertical scale.
Input Terminals	<p data-bbox="398 1134 449 1155">CH4</p> 	Accepts input signals. Input impedance, selectable: 50Ω, 75Ω, 1MΩ.
Math key		Use the math key to set and configure math functions.

Reference key		Press the Reference key to set or remove reference waveforms.
BUS keys		The Serial bus decode keys are used for UART, I ² C and SPI serial bus interface decoding. The serial bus decode function is an optional extra. See page 95 for details.
Function Keys		The Function Keys are used to enter and configure different functions on the GDS-3000.
Measure		Configures and runs automatic measurements.
Cursor		Configures and runs cursor measurements.
Test		Configures and runs applications as well as optional functions such as the Power Analysis measurement software.
Acquire		Configures the Acquisition mode.
Display		Configures the display settings.
Help		Shows the Help menu.
Save/Recall		Used to save and recall waveforms, images and panel settings.
Utility		Configures the print key, display time, language and calibration.

USB host port

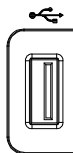

Type A, 1.1/2.0 compatible. Used for data transfer.

Ground terminal



Accepts the DUT ground lead for common ground.

Probe compensation output



Outputs 2Vp-p, square wave signal for probe compensation (page 191).

External trigger input



Accepts external trigger signals (page 126).

Input impedance: $1M\Omega \pm 3\%$,
Voltage input: $\pm 15V$ (peak), EXT trigger capacitance: $\sim 15pF$.

Power Switch

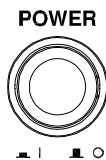

Used to turn the power on/off.

 I: ON

 O: OFF

Rear Panel

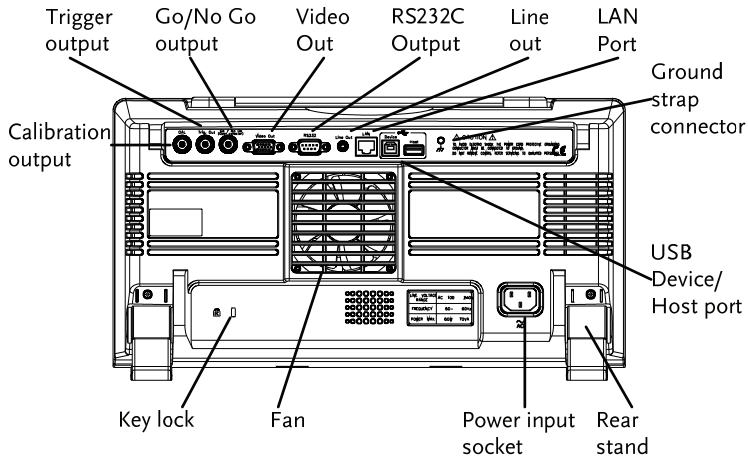

- Calibration output



Outputs the signal for vertical scale accuracy calibration (page 189).
- Trigger output



Outputs the trigger timing.
- Go-No Go output



Outputs Go-No Go test results (page 88) as 10us pulse signal.
- Video Out

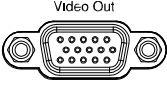

Outputs SVGA resolution to an external display.
- RS232

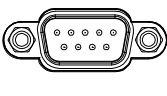

RS232 remote control.
- Line Out



Audio line out.

LAN port



Ethernet port.

Ground strap connector



For use with a grounding strap.

USB Device Port



The USB device port is used for remote control and for the FreeWave remote control software. USB 1.1/2.0 high speed compatible.

USB Host



The USB host port supports USB flash drives for external memory. USB 1.1/2.0 high speed compatible.

Security Slot



Kensington security slot compatible.

Power Input Socket

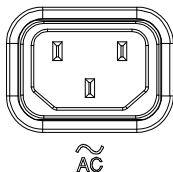

Power cord socket accepts AC mains, 100 ~ 240V, 50/60Hz.

For power up sequence, see page 29.

Display

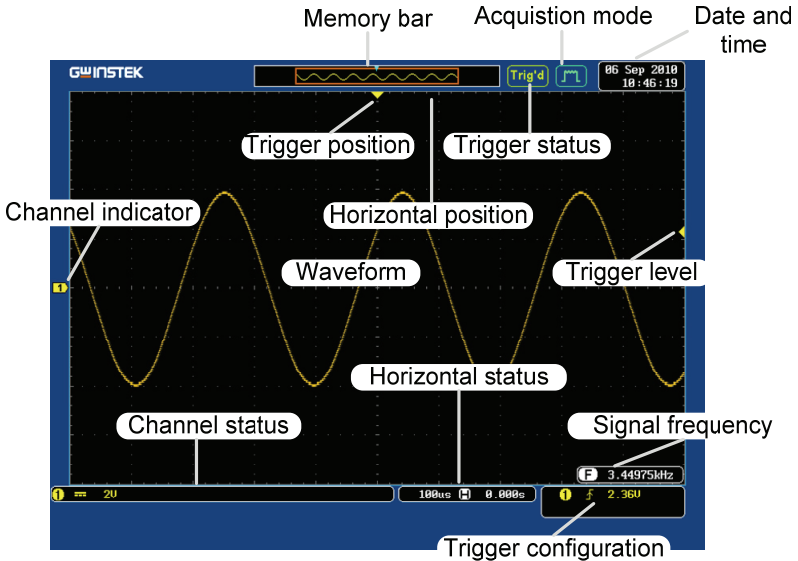

Waveforms

Shows input signal waveforms.

Channel 1: Yellow

Channel 2: Blue

Channel 3: Pink

Channel 4: Green

Channel Indicator

The channel indicator shows the zero volt level of the signal waveform for each activated channel. The active channel is shown with a solid color.

M Math

B1 Bus (B1)

3 Active channel (CH3)

1 Reference waveform (Ref1)

4 Activated channel (CH4)

Trigger position

Shows the position of the trigger.

Horizontal position

Shows the horizontal position.

Date and Time  Current date and time (page 145).

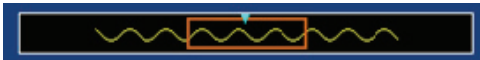
Memory bar 

The ratio and the position of the displayed waveform compared with the internal memory (page 114).

Trigger status  Triggered.

 Not triggered, display not updated.

 Indicates the pre-trigger is active.

 Trigger stopped. Also appears in Run/Stop (page 62).

 Roll mode.

 Autoset mode.

For trigger details, see page 126.

Acquisition mode  Normal mode

 Peak detect mode

 Hi Resolution

 Average mode

For acquisition details, see page 101.

Input signal frequency  Shows the input signal frequency.

 Indicates the frequency is less than 2Hz (lower frequency limit).

Trigger configuration

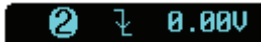

Trigger source, slope, voltage.



Trigger source, trigger (video), field, line.

For trigger details, see page 126.

Channel status



Channel 1, inverted, AC coupling, 1V/Div



Channel 1, GND coupling, 1V/Div

For channel details, see page 119.

Set Up

Tilt Stand

Upright

Turn the legs under the casing as shown below to have the instrument sit upright.

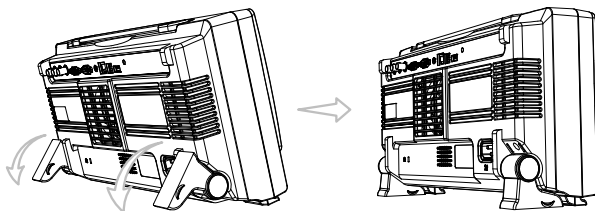

Tilt

To tilt, tilt the legs back behind the casing, as shown below.

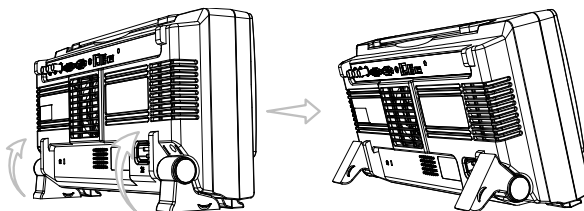

Power Up

Step

1. Connect the power cord to the rear panel socket.

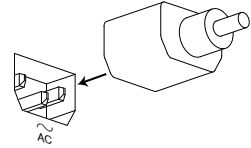

2. Press the POWER key. The display becomes active in ~ 30 seconds.

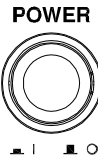

■ I: ON

■ ○: OFF

Note

The GDS-3000 recovers the state right before the power is turned OFF. The default settings can be recovered by pressing the Default key on the front panel. For details, see page 161.

First Time Use

Background This section describes how to connect a signal, adjust the scale, and compensate the probe. Before operating the GDS-3000 in a new environment, run these steps to make sure the instrument performs at its full potential.

1. Power On Follow the procedures on the previous page.

2. Set the date and time Set the date and time. Page 145

3. Reset system Reset the system by recalling the factory settings. Press the *Default Setup* key on the front panel. For details, see page 161.



4. Install optional software The optional software packages (Power Analysis, Serial Bus Decode) can be activated. If the optional software has not been purchased, a time trial demonstration can be activated. Page 193

5. Connect probe Connect the probe to the Channel1 input terminal and probe compensation signal output (2Vp-p, 1kHz square wave).
Set the probe attenuation to x10 if the probe has adjustable attenuation.

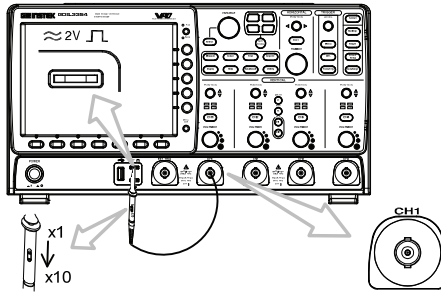

6. Capture signal (Autoset)

Press the *Autoset* key. A square waveform appears on the center of the screen. For Autoset details, see page 61.

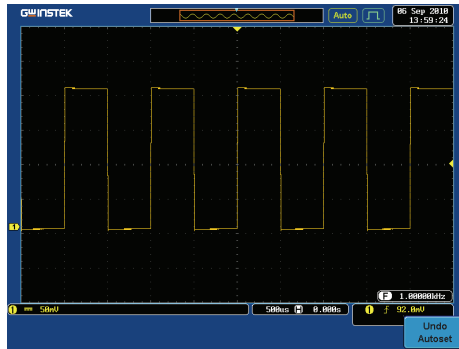

7. Select vector waveform

Press the *Display* key, and set the display to *Vector* on the bottom menu.

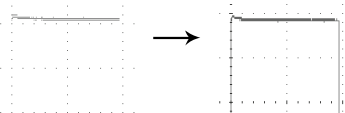

8. Compensate probe

Turn the adjustment point on the probe to make the square waveform edge flat.

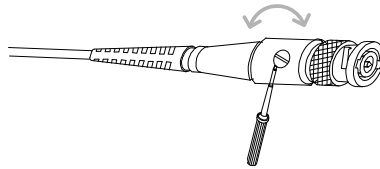
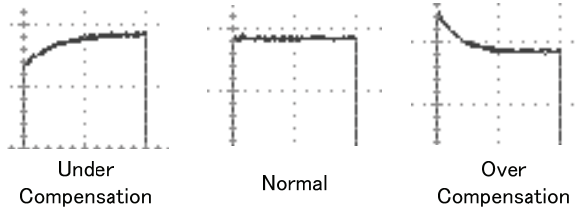

9. Start operation Continue with the other operations.

Measurement: page 56 Configuration: page 88

Save/Recall page 147 File Utilities page 167

Print Out 177 Remote Control
page 181

How to Use This Manual

Background This section describes the conventions used in this manual to operate the GDS-3000.

Throughout the manual any reference to pressing a menu key refers to the keys directly below or beside any menu icons or parameters.

When the user manual says to “toggle” a value or parameter, press the corresponding menu item. Pressing the item will toggle the value or parameter.

Active parameters are highlighted for each menu item. For example in the example below, Coupling is currently set to DC.

If a menu item can be toggled from one value or parameter to another, both options will be visible, with the current option highlighted. In the example below the slope can be toggled from a rising slope to a falling slope.



Selecting a menu item or parameter When the user manual says to “select” a value from one of the side menu parameters, first press the corresponding menu key and use the variable knob to either scroll through a parameter list or to increase or decrease a variable.

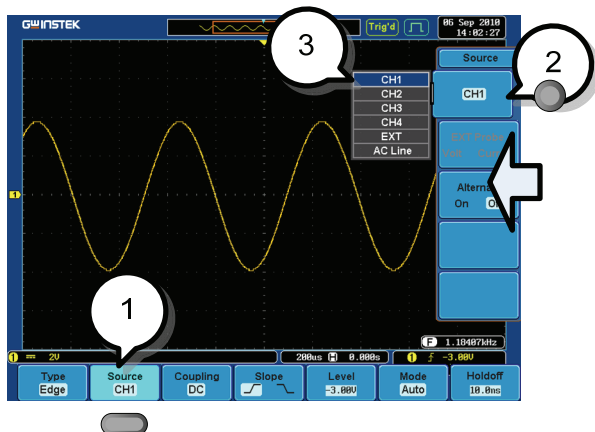

Example

1. Press a bottom menu key to access the side menu.

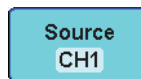

2. Press a side menu key to either set a parameter or to access a sub menu.

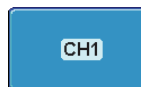

3. If accessing a sub menu or setting a variable parameter, use the variable knob to scroll through menu items or variables. Use the select key to confirm and exit.

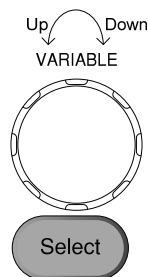

4. Press the same bottom menu key again to reduce the side menu.

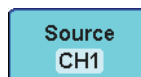

toggling a menu parameter

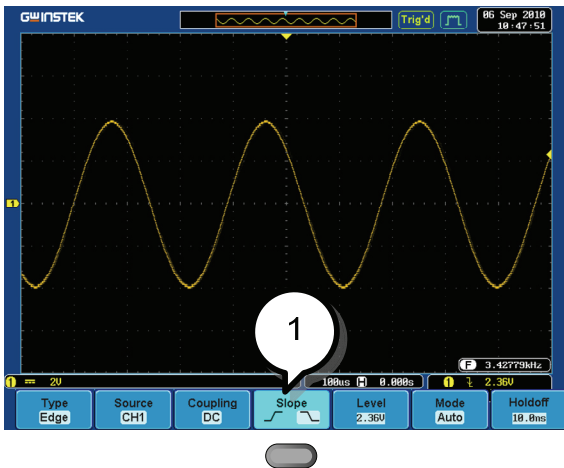

1. Press the bottom menu key to toggle the parameter.



Reduce Lower Menu

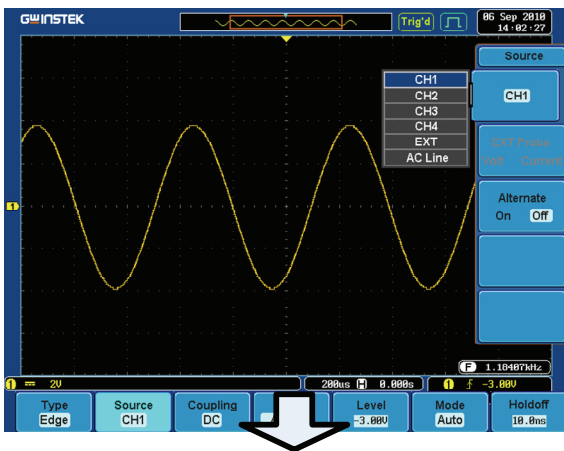

1. Press the relevant function key again to reduce the bottom menu. For example: press the trigger menu key to reduce the trigger menu.

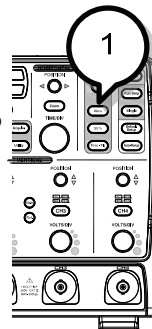

Remove all menus

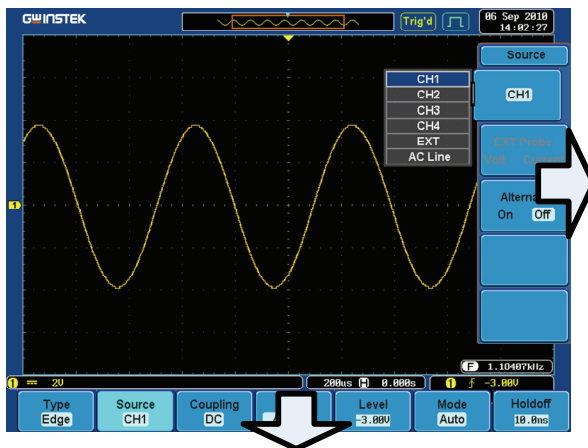

1. Press the Menu Off key to reduce each menu level.

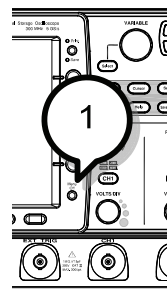

QUICK REFERENCE

This chapter describes the GDS-3000 menu tree, shortcuts to major operations, built-in Help access, and default factory settings. Use them as a handy reference to get a quick access to the functionality.

Menu Tree / Operation Shortcuts	39
Convention	39
Acquire Key	40
Autoset Key	40
Auto-Range	40
CH1 ~ 4 Key	41
Cursor Key	41
Display Key	42
Help Key	42
Math Key	43
Measure Key	44
Print/Save Key	45
Run/Stop Key	45
REF Key	45
Save/Recall Key	46
Test Key	47
Test Key – Go-NoGo	47
Trigger Type Menu	48
Trigger Edge Menu	48
Trigger Delay Menu	48
Trigger Pulse Width Menu	49
Trigger Video Menu	49
Trigger Pulse Runt Menu	49
Trigger Rise & Fall Menu	50
Utility Key	50
Utility Key – I/O	51
Utility Key – File Utilities	51
Utility Key – Self Calibration	51

Zoom Key.....	52
Default Settings	53
Built-in Help	55

Menu Tree / Operation Shortcuts

Convention

For all menu trees, bottom menu keys are shown as grey icons and side menu keys are shown in white. All menu tree operations are shown in order from top to bottom.

Below is an example of the menu tree operation for the trigger source menu and a comparison to the operation on the DSO screen.

Menu tree

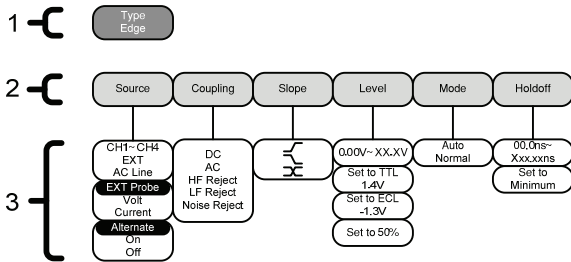

On screen menu

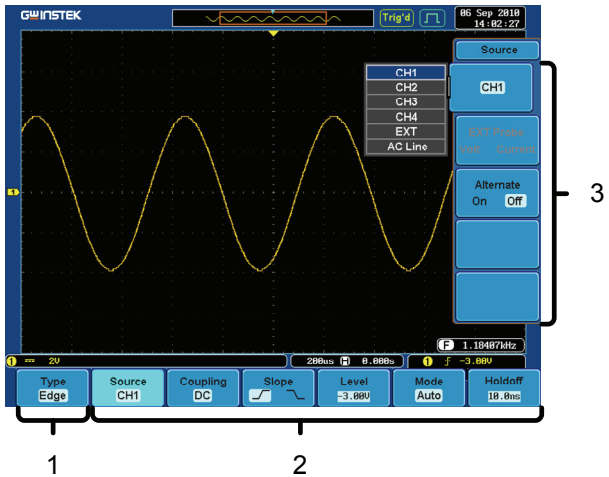

Acquire Key

Sets the acquisition mode.

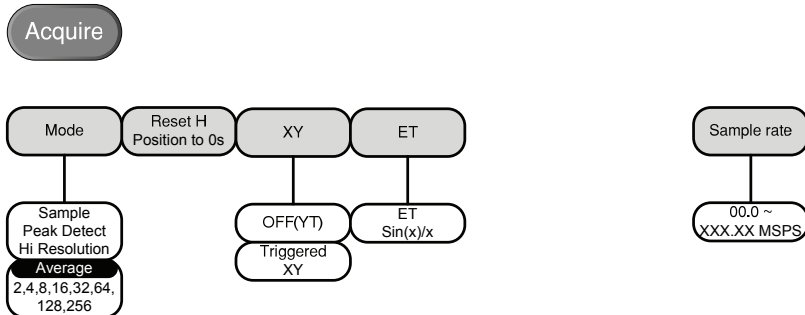

Autoset Key

Automatically finds the signal and sets the horizontal and vertical scale.



Auto-Range

Constantly adjusts the vertical and or horizontal scale.

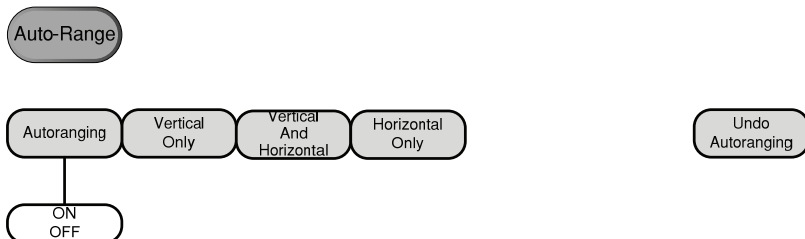

CH1 ~ 4 Key

Set the channel input parameters.

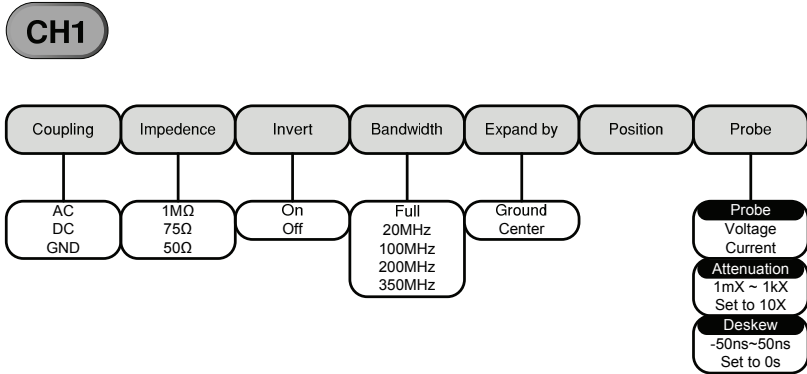

Cursor Key

Set cursor positions.

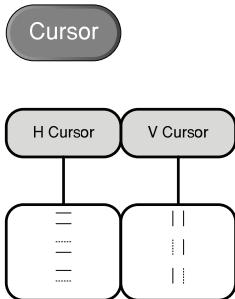

Display Key

Set the display properties.

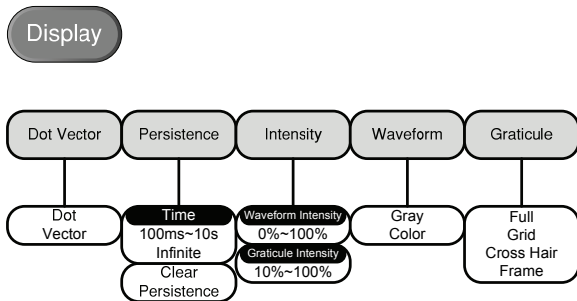

Help Key

Turn help mode On/Off.



Math Key



Standard math and FFT functions.

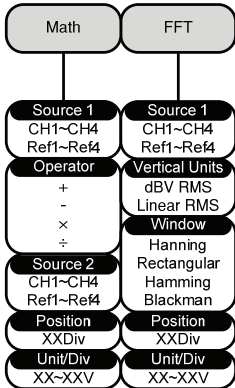

Measure Key

Display automatic measurements either individually or as voltage/current, time or delay measurement groups.

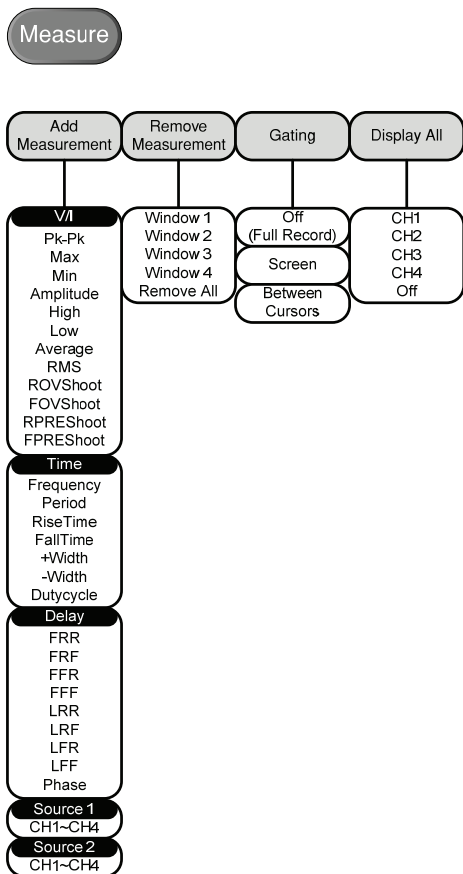

Print/Save Key

- Print Print or save screen images.



- Save

Run/Stop Key



Freeze/unfreeze signal acquisition

REF Key

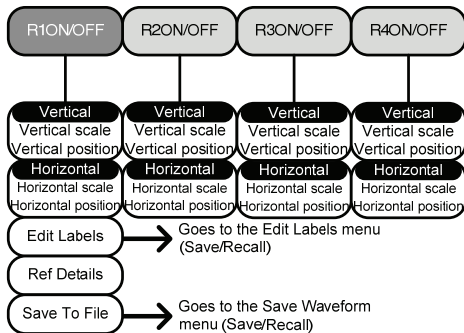

Save/Recall Key

Save and recall images, waveforms and panel setups. Edit labels for reference and setup files.

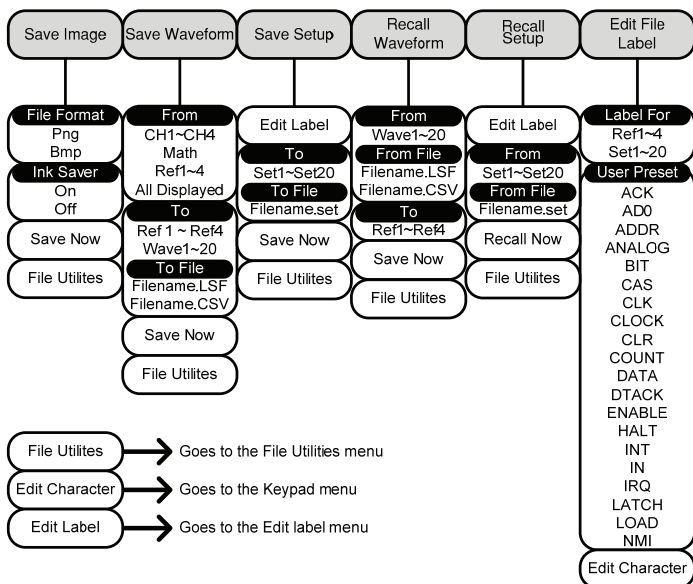

Test Key

Use the Go-NoGo application as well as additional optional software such as the Power Analysis software.

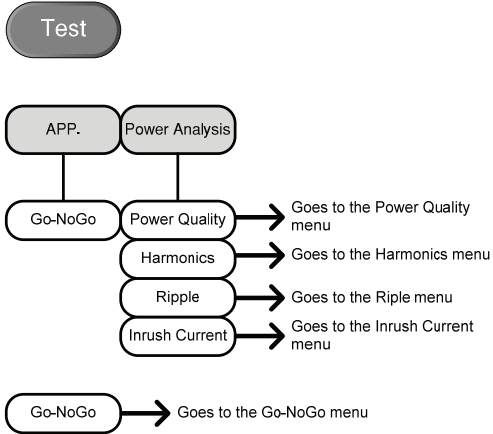

Test Key – Go-NoGo

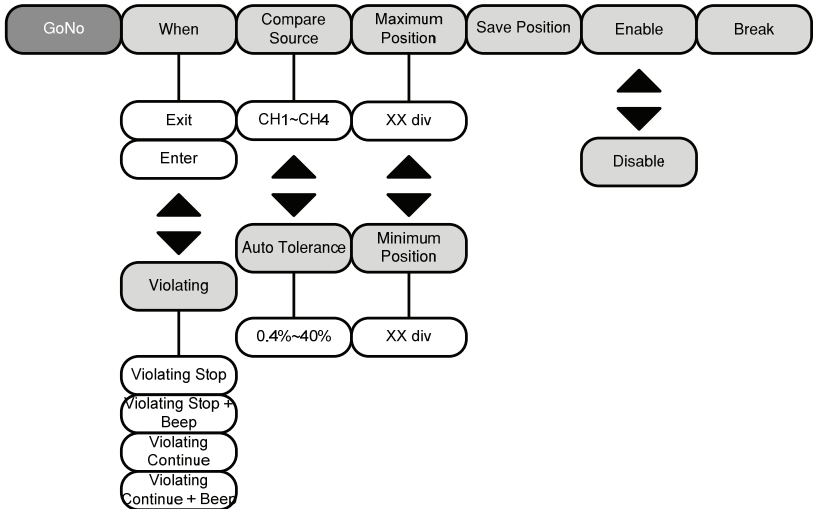

Trigger Type Menu

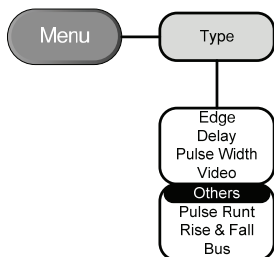

Trigger Edge Menu

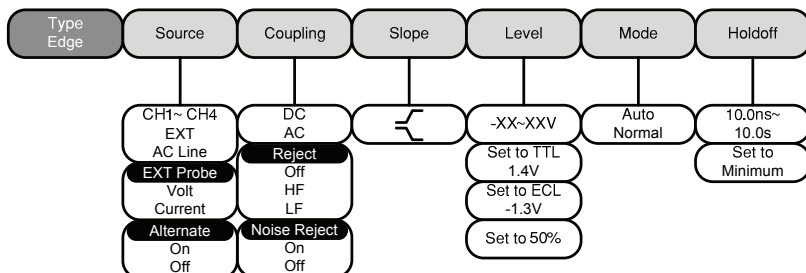

Trigger Delay Menu

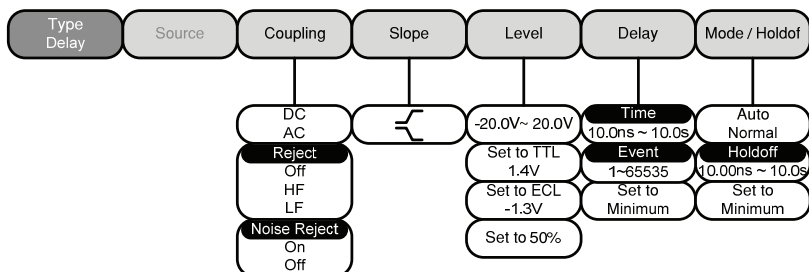

Trigger Pulse Width Menu

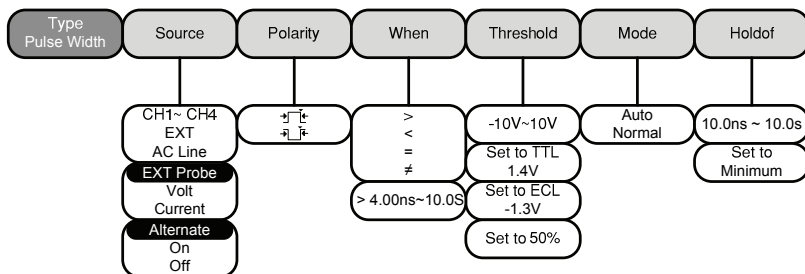

Trigger Video Menu

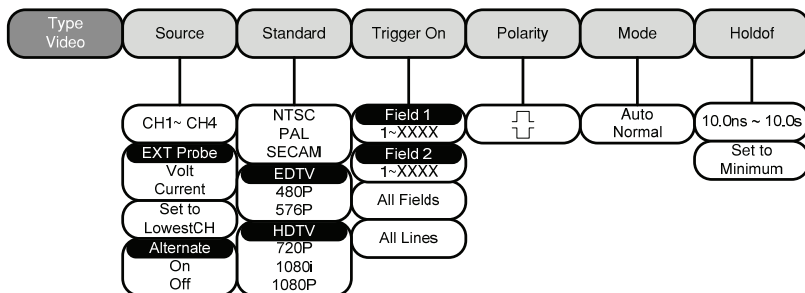

Trigger Pulse Runt Menu

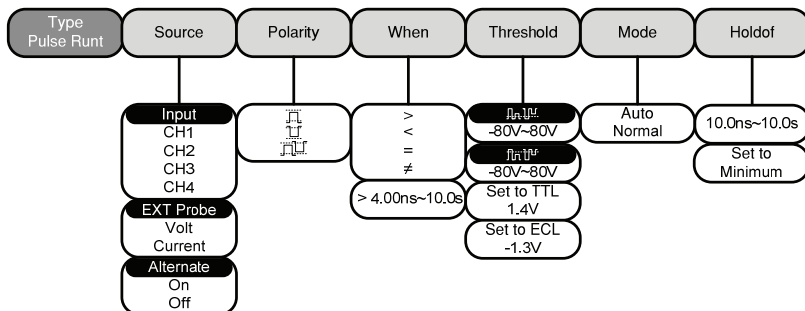

Trigger Rise & Fall Menu

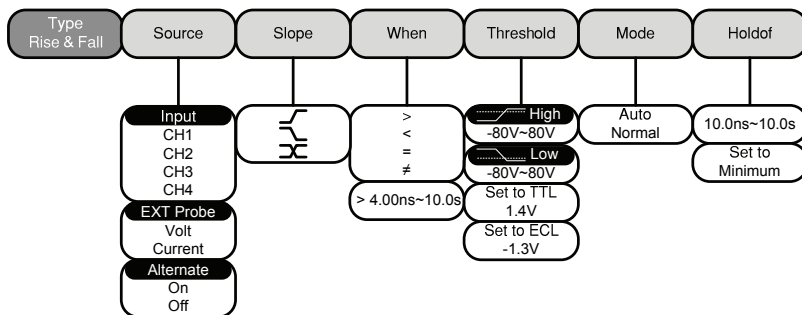

Utility Key

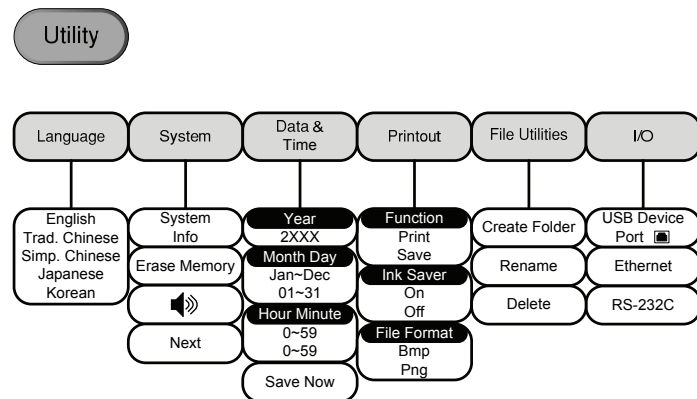

- Next → Goes to the System Self Cal menu
- USB Device Port → Goes to the I/O USB Device Port menu
- Ethernet → Goes to the I/O Ethernet menu
- RS-232C → Goes to the I/O RS232 menu
- Create Folder → Goes to the File Utilities
- Rename → Goes to the File Utilities

Utility Key – I/O

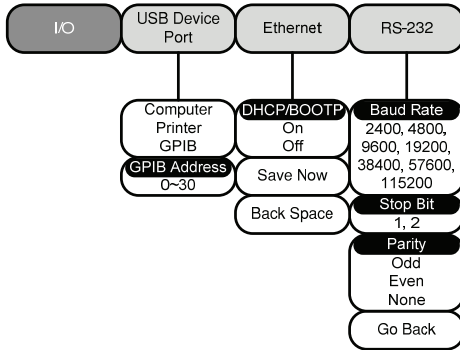

Utility Key – File Utilities

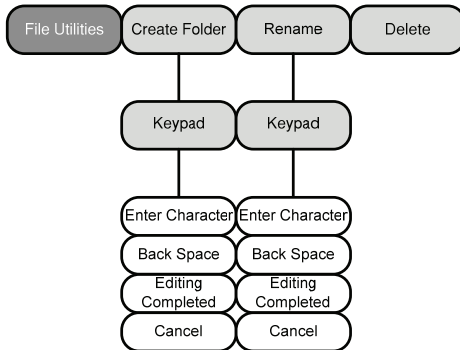

Utility Key – Self Calibration

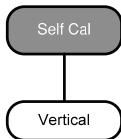

Zoom Key

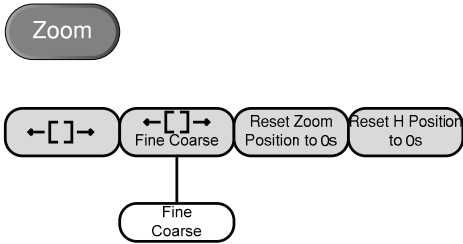

Default Settings

The default factory installed settings can be recalled at any time by pressing the *Default Setup* key.



Acquire	Mode: Sample Sample mode: ET Sample rate: 250MSPS	XY: OFF Delay: On
Display	Mode: Vector Waveform intensity: 50% Waveform visuals: Gray	Persistence: 100ms Graticule intensity: 50% Graticule: full 
Channel	Scale: 100mV/Div Coupling: DC Invert: Off Expand: By ground Probe: voltage Deskew: 0s	CH1: On Impedance: 1MΩ Bandwidth: full Position: 0.00V Probe attenuation: 1x
Cursor	Horizontal cursor: Off	Vertical Cursor: Off
Measure	Source: CH1 Display: Off	Gating: Off
Horizontal	Scale: 10us/Div	
Math	Source1: CH1 Source2: CH2 Unit/Div: 200mV	Operator: + Position: 0.00 Div Math Off
Test	App: Go-NoGo	
Trigger	Type: Edge Coupling: DC	Source: CH1 Alternate: Off

	Rejection: Off	Noise Rejection: Off
	Slope: positive	Level: 0.00V
	Mode: Auto	Holdoff: 10.0ns
Utility	Language: English	Volume: 60%
	Print key: Save	Ink Saver: Off
	USB device: Computer	USB class: CDC
Save recall	Image file format: Bmp	Data file format: LSF

Built-in Help

The Help key accesses a context sensitive help menu. The help menu contains information on how to use the front panel keys.

- Panel operation
1. Press the *Help* key. The display changes to Help mode.



2. Use the Variable knob to scroll up and down through the Help contents. Press *Select* to view the help on the selected item.

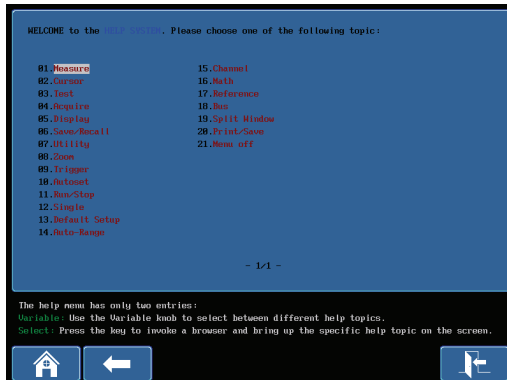

- Home key
- Press the *Home* key to return to the main help screen.



- Go back
- Press the *Back* key to go to the previous menu page.



- Exit
- Press the *Help* key again or press the *Exit* key to exit the Help mode.



M EASUREMENT

Basic Measurement	59
Channel Activation	59
Autoset	61
Auto Range	62
Run/Stop	63
Horizontal Position/Scale.....	64
Vertical Position/Scale	66
Split Window Mode.....	67
Automatic Measurement.....	69
Measurement Items	69
Individual Mode	72
Remove Measurement.....	73
Gated Display All mode.....	74
Display All mode.....	75
Cursor Measurement	77
Use Horizontal Cursors.....	77
Use Vertical Cursors	80
Math Operation	83
Overview	83
Addition/Subtraction/Multiplication.....	84
FFT	86
Applications	88
Overview	88
Running Applications	88
Using Go_NoGo	90
Power Analysis	95
Power Analysis Overview	95

Serial Bus..... 96
 Serial Bus Overview..... 96

Basic Measurement

This section describes the basic operations required in capturing and viewing the input signal. For more detailed operations, see the following chapters.

- Cursor Measurement → from page 77
- Configuration → from page 88

Before operating the oscilloscope, please see the Getting Started chapter, page 11.

Channel Activation

Activate channel To activate an input channel, press a *channel* key.

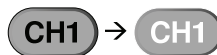

When activated, the channel key will light up. The corresponding channel menu will also appear.

Each channel is associated with the color shown beside the VOLTS/DIV dial: CH1: yellow, CH2: blue, CH3: pink and CH4: green.

When a channel is activated, it is shown above the bottom menu system.



De-activate channel To de-activate a channel, press the corresponding *channel* key again. If the channel menu is not open, press the *channel* key twice (the first press shows the Channel menu).

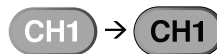

Default setup

To activate the default state, press *Default Setup*.



Autoset

The *Autoset* key (page 61) does NOT automatically activate the channels to which input signals are connected.

Autoset

Background The Autoset function automatically configures the panel settings to position the input signal to the best viewing condition. The GDS-3000 automatically configures the following parameters.

- Horizontal scale
 - Vertical scale
 - Trigger source channel
-

Panel operation 1. Connect the input signal to the GDS-3000 and press the *Autoset* key.

A blue rounded rectangular button with the word "Autoset" in white text.

2. The waveform appears in the center of the display.

Before

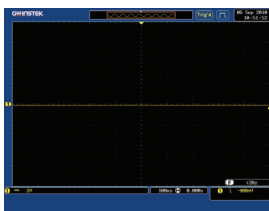

After

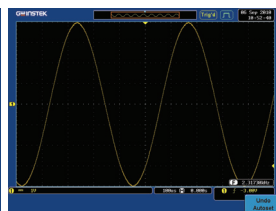

3. To undo Autoset, press *Undo Autoset* from the bottom menu. To remove the *Undo Autoset* softkey, press any other key.

A blue rounded rectangular button with the text "Undo Autoset" in white.

Limitation Autoset does not work in the following situation.

- Input signal frequency is less than 20Hz
- Input signal amplitude is less than 30mV

Auto Range

Background The Auto Range function works similarly to the Autoset function, except the Auto Range function works continuously when it is on. The Auto Range function will continuously monitor the input signal and adjust the horizontal and vertical scale of a displayed signal so that waveform(s) are displayed at the best possible scale.

In addition, the Auto Range function can be also be configured to only adjust the vertical or horizontal scale.

Panel operation

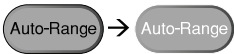
1. After a signal has already been triggered, press the *Auto-Range* key. The *Auto-Range* key lights up. 

2. The waveform appears in the center of the display.

Before

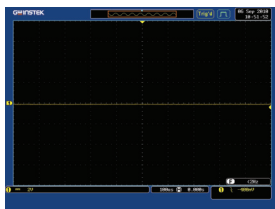

After

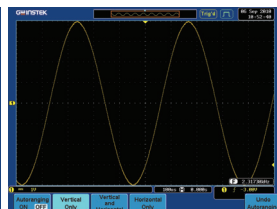

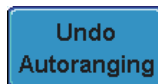

3. To undo Auto-Range, press *Undo Autoranging* from the bottom menu.

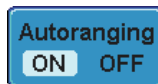

Disable Auto-Range Press *Autoranging* from the bottom menu to turn Auto-Range On/Off.



Configure Auto-Range	Press <i>Vertical Only</i> for vertical autoranging only.	
	Press <i>Horizontal Only</i> for horizontal autoranging only.	
	Press <i>Horizontal and Vertical</i> for autoranging on both axes.	

Limitation Auto Range does not work in the following situation.

- Input signal frequency is less than 20Hz
- Input signal amplitude is less than 30mV

Run/Stop

Background By default, the waveform on the display is constantly updated (Run mode). Freezing the waveform by stopping signal acquisition (Stop mode) allows flexible observation and analysis. To enter Stop mode, two methods are available: pressing the Run/Stop key or using the Single Trigger mode.

Stop mode icon When in Stop mode, the Stop icon appears at the top of the display.



Triggered icon



Freeze waveform by Run/Stop key Press the *Run/Stop* key once. The waveform and signal acquisition freezes. To unfreeze, press the *Run/Stop* key again.



Freeze waveform by Single Trigger mode

In the Single Trigger mode, the waveform always stays in the Stop mode, and is updated only when the *Single* key is pressed. When the *single* key is pressed, the Run/Stop key turns red. For details, see page 126.

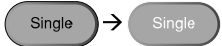

Waveform operation

The waveform can be moved or scaled in both Run and Stop mode, but in different manners. For details, see page 114 (Horizontal position/scale) and page 119 (Vertical position/scale).

Horizontal Position/Scale

For more detailed configuration, see page 114.

Set horizontal position

The horizontal position knob moves the waveform left and right.



As the waveform moves, the memory bar on the top of the display indicates the portion of the waveform currently shown on the display and the position of the horizontal marker on the waveform.

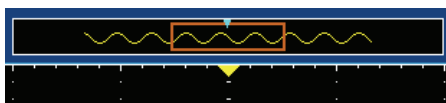

Position Indicator The horizontal position is shown at the bottom of the display grid to the right of H icon.



Select horizontal scale To select the timebase (scale), turn the *TIME/DIV* knob; left (slow) or right (fast).

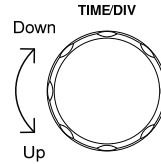

Range 1 ns/div ~ 100 s/div, 1-2-5 increments

The Time/Division rate is displayed to the left of the H icon at the bottom of the screen.



Memory bar The size of the memory bar changes to reflect the timebase and the section of waveform that is displayed on screen.

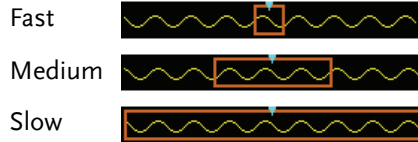

The Sample rate changes according to the time/division. See page 106.

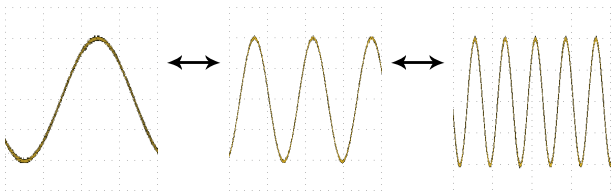

10ms	5ms	2ms
250KPS	500KSPS	1MSPS

Stop mode In the Stop mode, the waveform size changes according to the scale.

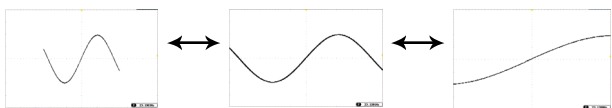

Vertical Position/Scale

For more detailed configuration, see page119.

Set vertical position

To move the waveform up or down, turn the *vertical position knob* for each channel.

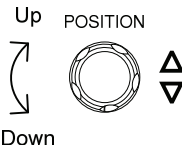

As the waveform moves, the vertical position of the cursor appears on the display.

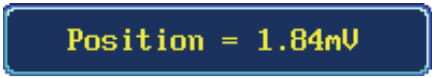

Run/Stop mode

The waveform can be moved vertically in both Run and Stop mode.

Select vertical scale

To change the vertical scale, turn the *VOLTS/DIV knob*; left (down) or right (up).

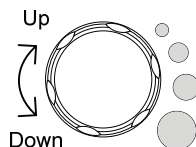

Range 2mV/div ~ 1V/div (50Ω/75Ω)/,
 2mV/div ~ 5V/div (1MΩ)
 1-2-5 increments



The vertical scale indicator for each channel on the bottom of the display changes accordingly.



Split Window Mode

The split window mode is able to display and trigger each active channel independently. The split window mode is especially useful for signal comparisons. Reference waveforms can also be used in this mode. All functions and features can be used with split screen mode bar the Math, XY display and Zoom mode.

Enter Split screen mode

1. Activate each channel that is to be used in the split screen mode.  →  page 59

2. Press the *Split Window* key to enter the split screen mode.



3. Split window mode appears. The number of windows depends on the number of active channels.

Example

4 channel split window

2 channel split window

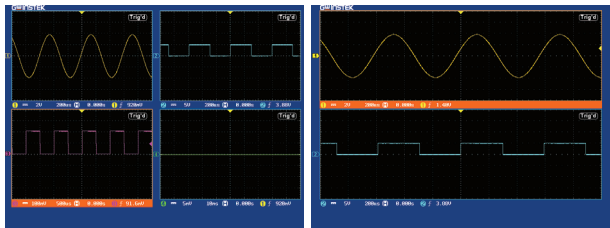

Select active channel

The split window that has the active channel is shown with an orange border.

To select the active channel, press the corresponding split window key. In order from top-left, clockwise: CH1, CH2, CH3, CH4.

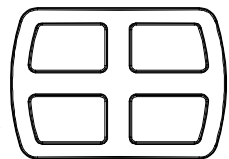

Example

CH4 Not active

CH4 Active

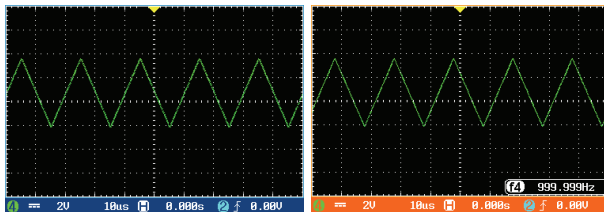





























Reference Waveforms

Reference waveforms can also be used in this mode. Each reference waveform will be recalled to the corresponding split window number. I.e., Ref1 will be recalled to first split window, Ref2 to the second window and so on.





Automatic Measurement



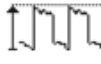
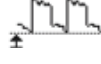
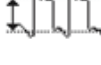

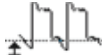
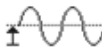

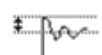
The automatic measurement function measures and updates major items for Voltage/Current, Time, and Delay type measurements.

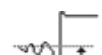
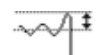







Measurement Items

	V/I Measurements	Time Meas.	Delay Meas.			
Overview	Pk-Pk		Frequency		FRR	
	Max		Period		FRF	
	Min		RiseTime		FFR	
	Amplitude		FallTime		FFF	
	High		+Width		LRR	
	Low		-Width		LRF	
	Average		Dutycycle		LFR	
	RMS				LFF	
	ROVShoot				Phase	
	FOVShoot					
	RPREShoot					
	FPREShoot					

Voltage/Current measurement	Pk-Pk (peak to peak)		Difference between positive and negative peak voltage (=Vmax - Vmin)
	Max		Positive peak voltage
	Min		Negative peak voltage
	Amplitude		Difference between global high and global low voltage (=Vhi - Vlo)

High		Global high voltage
Low		Global low voltage
Average		Averaged voltage of the first cycle
RMS		RMS (root mean square) voltage
ROVShoot		Rise overshoot voltage
FOVShoot		Fall overshoot voltage
RPREShoot		Rise preshoot voltage
FPREShoot		Fall preshoot voltage

Time measurement	Frequency		Frequency of the waveform
	Period		Waveform cycle time (=1/Freq)
	RiseTime		Rising time of the pulse (~90%)
	FallTime		Falling time of the pulse (~10%)
	+Width		Positive pulse width
	-Width		Negative pulse width
	Duty Cycle		Ratio of signal pulse compared with whole cycle =100x (Pulse Width/Cycle)

Delay measurement	FRR		Time between: Source 1 first rising edge and Source 2 first rising edge
	FRF		Time between: Source 1 first rising edge and Source 2 first falling edge
	FFR		Time between: Source 1 first falling edge and Source 2 first rising edge
	FFF		Time between: Source 1 first falling edge and Source 2 first falling edge
	LRR		Time between: Source 1 first rising edge and Source 2 last rising edge
	LRF		Time between: Source 1 first rising edge and Source 2 last falling edge
	LFR		Time between: Source 1 first falling edge and Source 2 last rising edge
	LFF		Time between: Source 1 first falling edge and Source 2 last falling edge
	Phase		The phase difference of two signals, calculated in degrees. $T1 \div T2 \times 360$.

Individual Mode

Individual mode shows up to eight selected measurement items on bottom of the screen from any channel source.

Add measurement item

1. Press the *Measure* key.
2. Press *Add Measurement* from the bottom menu.
3. Choose either a *V/I*, *Time* or *Delay* measurement from the side menu.

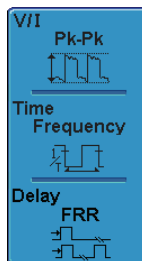
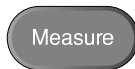

- | | |
|------------------------------|---|
| V/I
(Voltage/
Current) | Pk-Pk, Max, Min, Amplitude, High, Low, Average, RMS, ROVShoot, FOVShoot, RPREShoot, FPREShoot |
| Time | Frequency, Period, RiseTime, FallTime, +Width, -Width, Duty Cycle |
| Delay | FRR, FRF, FFR, FFF, LRR, LRF, LFR, LFF, Phase |

4. All individual measurements will be displayed in a window on the bottom of the screen. The channel number and channel color indicate the measurement source: yellow = CH1, blue = CH2, pink = CH3, green = CH4.



Choose a Source The channel source for measurement items can be set either before or when selecting a measurement item.

1. To set the source, press either the *Source1* or *Source2* key from the side menu and choose the source. Source 2 is only for delay measurements.

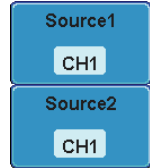

Range CH1, CH2, CH3, CH4

Split Window Mode Individual mode can be used with the split window mode. Each individual measurement will be displayed in the split window that houses the source of the measurement.

Delay measurements are not supported as only one source can be used for each measurement in split window mode.

Remove Measurement

Individual measurements can be removed at any time using the Remove Measurement function.

Remove measurement item

1. Press the *Measure* key.
2. Press *Remove Measurement* from the bottom menu.
3. Choose which measurement window (if in split window mode) the item is located in (*Window 1~4*) and use the variable knob to remove an item.

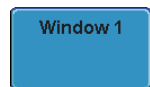

Remove all items Press *Remove All* to remove all the measurement items in full screen mode, or to remove all the measurement items for the active window in split screen mode.

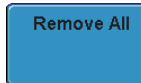

Gated Display All mode

Display All mode can be customized to limiting measurement to a "gated" area between cursors. Gating is useful for measuring a magnified waveform or when using a fast time base. The Gated mode has three possible configurations: Off (Full Record), Screen and Between Cursors.

Set Gating mode 1. Press the *Measure* key.



2. Press *Gating* from the bottom menu.

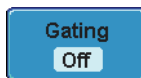

3. Choose one of the gating modes from the side menu: *Off (full record)*, *Screen*, *Between Cursors*

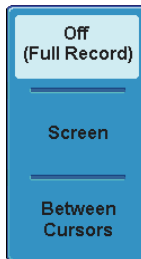

Cursors on screen

If *Between Cursors* is selected, the cursor positions can be edited by using the cursor menu.

Page 77

Display All mode

Display All mode shows and updates all items from Voltage and Time type measurements.

View measurement results

1. Press the *Measure* key.



2. Press *Display All* from the bottom menu.



3. Choose a channel (*CH1, CH2, CH3, CH4*) from the side menu to display auto measurement items.

Note: only the channels that are activated are available.

4. The results of Voltage and Time type measurements appear on the display.



Remove measurements

To remove the measurement results, press *OFF*.



Delay Measurements Delay type measurement is not available in this mode as only one channel is used as the source. Use the Individual measurement mode (page 72) instead.

Cursor Measurement

Horizontal or vertical cursors are used to show the position and values of waveform measurements and math operation results. These results cover voltage, time, frequency and other math operations. When the cursors (horizontal, vertical or both) are activated, they will be shown on the main display unless turned off. (page 113).

Use Horizontal Cursors

Panel operation/ Range 1. Press the *Cursor* key once.

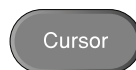

2. Press *H Cursor* from the bottom menu.

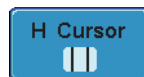

3. Press H Cursor repeatedly to toggle the cursor type.

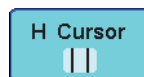

Range

| ∷ Left cursor movable, right cursor position fixed

∷ | Right cursor movable, left cursor position fixed

| | Left and right cursor movable together

4. The cursor position information appears on the top left hand side of the screen



5. Use the *Variable knob* to move the movable cursor(s) left or right.

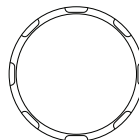

Cursors Time, Voltage/Current
 Δ Delta (difference between cursors)

Example

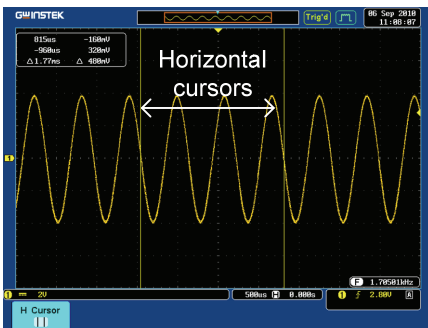

FFT Math

The FFT Math has different content. For FFT math details, see page 86.

747.5kHz	-68.0dB
1.997MHz	-68.0dB
Δ 1.250MHz	Δ 0.00dB

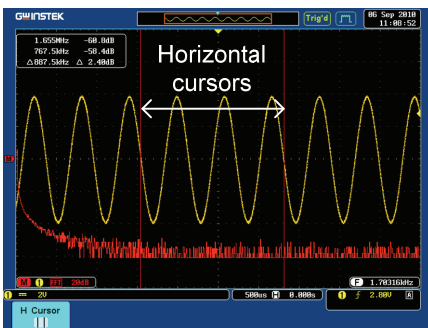

Cursors Frequency, dB/V
 Δ Delta (difference between cursors)

Example

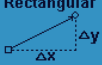
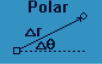

XY mode

XY mode cursors measure a number of X by Y measurements.

① (X) Versus ② (Y)	Cursor1	Cursor2	Δ
Rectangular 	t: -250.0us	250.0us	500.0us
Polar 	x: -90.0nV y: -10.0nV	110nV 7.20nV	200nV 17.2nV
Product 	r: 90.5nV θ: 6.34Deg	110nV 3.74Deg	19.6nV 2.59Deg
Ratio	x×y: 900uVU	792uVU	108uVU
	y÷x: 111nV/V	65.4nV/V	45.6nV/V

Cursors Time, rectangular, polar coordinates, products, ratio.

Δ Delta (difference between cursors)

Example

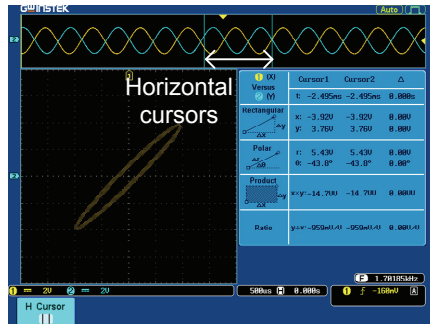

Use Vertical Cursors

Panel operation/
Range

1. Press the *Cursor* key twice.



2. Press *V Cursor* from the bottom menu.

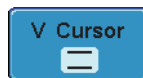

3. Press *V Cursor* repeatedly to toggle the cursor type.

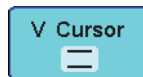

Range



Upper cursor movable, lower cursor position fixed



Lower cursor movable, upper cursor position fixed



Upper and lower cursor movable together

4. The cursor position information appears on the top left hand side of the screen.



5. Use the *Variable knob* to move the cursor(s) up or down.

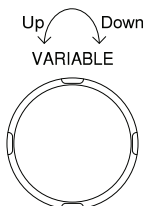

Cursors



Time, Voltage/Current



Delta (difference between cursors)

Example

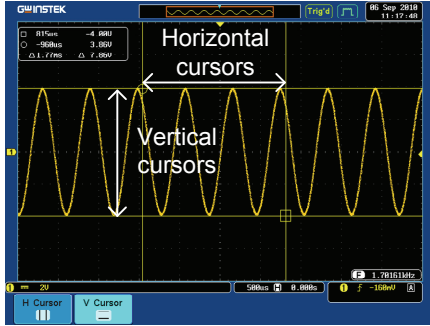

FFT Math

The FFT Math has different content. For FFT math details, see page 86.

□	1.490MHz	43.3dB
○	3.495MHz	-43.3dB
Δ	2.005MHz	86.6dB

Cursors



Frequency, dB/V





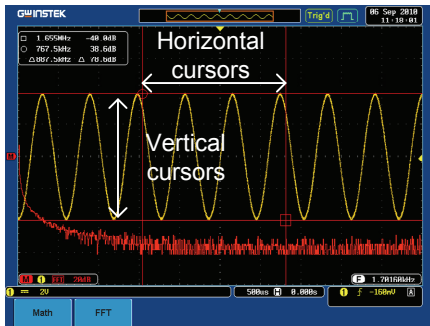

Delta (difference between cursors)



Example



XY mode

XY mode cursors measure a number of X by Y measurements.

 (X) Versus  (Y)	Cursor1	Cursor2	Δ
	t:		
Rectangular 	x: 5.80nV	199nV	194nV
	y: 14.2nV	-12.2nV	26.4nV
Polar 	r: 15.8nV	199nV	184nV
	θ : 70.6Deg	-3.50Deg	74.1Deg
Product 	x×y: 71.8uV	-2.42nV	2.49nV
Ratio	y÷x: 2.84V/V	-61.3nV/V	2.90V/V

- Cursors   Rectangular, polar co-ordinates, products, ratio.
-  Delta (difference between cursors)

Example

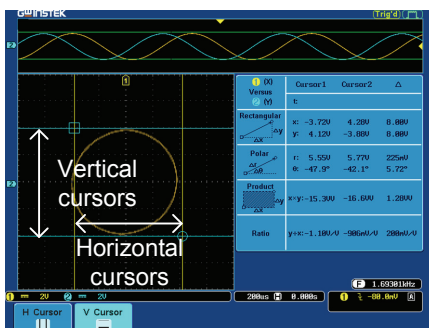



Math Operation

Overview

Background	Math operation runs addition, subtraction, multiplication, division or FFT using the input signals or reference waveforms (Ref1~4) and shows the result on the display. The resulted waveform characteristics can be measured using the cursors.	
Addition (+)	Adds the amplitude of two signals.	
	Source	CH1~4, Ref1~4
Subtraction (-)	Extracts the amplitude difference between two signals.	
	Source	CH1~4, Ref1~4
Multiplication (×)	Multiplies the amplitude of two signals.	
	Source	CH1~4, Ref1~4
Division (÷)	Divides the amplitude of two signals.	
	Source	CH1~4, Ref1~4
FFT	Runs FFT calculations on a signal. Four types of FFT windows are available: Hanning, Hamming, Rectangular, and Blackman.	
	Source	CH1~4, Ref1~4
Hanning FFT window	Frequency resolution	Good
	Amplitude resolution	Not good
	Suitable for....	Frequency measurement on periodic waveforms

Hamming FFT window	Frequency resolution	Good
	Amplitude resolution	Not good
	Suitable for...	Frequency measurement on periodic waveforms
Rectangular FFT window	Frequency resolution	Very good
	Amplitude resolution	Bad
	Suitable for...	Single-shot phenomenon (this mode is the same as having no window at all)
Blackman FFT window	Frequency resolution	Bad
	Amplitude resolution	Very good
	Suitable for...	Amplitude measurement on periodic waveforms

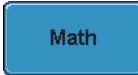
Addition/Subtraction/Multiplication

- Panel operation
1. Press the *Math* key.
 
 2. Press the *Math* key on the lower bezel.
 
 3. Select *Source 1* from the side menu
 

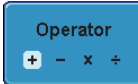
Range CH1~4, Ref~4
 4. Press *Operator* to choose the math operation.
 

Range +, -, x, ÷

5. Select *Source 2* from the side menu.

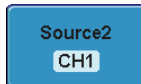

Range CH1~4, Ref~4

6. The math measurement result appears on the display. The vertical scale of the math waveform appears at the bottom of the screen.



From left: Math function, source1, operator, source2, Unit/div

Example

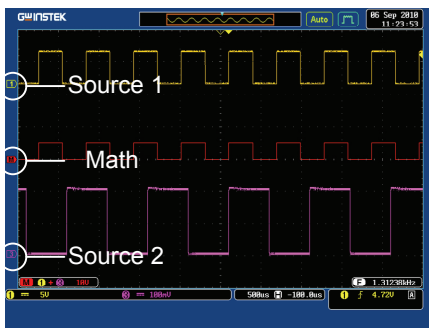

Position and Unit To move the math waveform vertically, press the *Position* key from the side menu and use the variable knob to set the position.



To change the unit/div settings, press *Unit/div*, then use the variable knob change the unit/div.

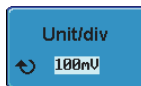



Range 2mV~1kV

Clear Result

To clear the Math result from the display, press the *Math* key again.



FFT

- Panel operation
1. Press the *Math* key. 
 2. Press *FFT* from the bottom menu. 
 3. Select the *Source* from the side menu. 

Range CH1~4, Ref~4
 4. Press the *Vertical Units* key from the side menu to select the vertical units used. 

Range Linear RMS, dBV RMS
 5. Press the *Window* key from the side menu and select the window type. 

Range Hanning, Hamming, Rectangular, and Blackman.
 6. The FFT result appears. For FFT, the horizontal scale changes from time to frequency, and the vertical scale from voltage/current to dB/RMS.

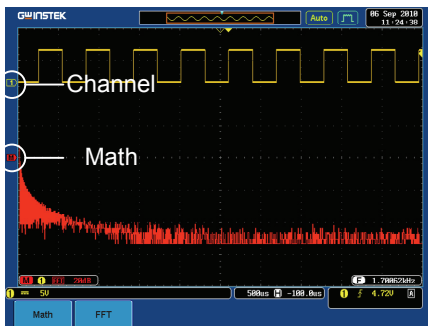

Position and unit To move the FFT waveform vertically, press *Position* and use the variable knob.



Range -12.00 Div ~ +12.00 Div

To select the vertical scale of FFT waveform, press *Unit/div* and use the variable knob.

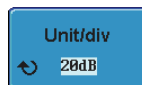

Range 2mV~1kV RMS, 1~20 dB

Clear FFT To clear the FFT result from the display, press the *Math* key again.



Applications

Overview

Background The APP. function allows different applications to be run. Applications can be downloaded from the GW Instek website.

Applications GO-NOGO The GO_NOGO application can be used to set threshold levels for input signals. GO-NOGO checks if a waveform fits inside a user-specified maximum and minimum amplitude boundary (template).

Running Applications

Background The APP. function can host a number of different applications that can be downloaded from the GW Instek website.

Panel operation 1. Press the *Test* key.



2. Press *APP.* from the bottom menu.



3. Scroll through each Application using the Variable knob.



4. Select an application by pressing the *Select* key *twice*.



×2

Using Go_NoGo

Background

The Go-NoGo test checks if a waveform fits inside a user-specified maximum and minimum boundary (boundary template). Boundary templates are automatically created from a source channel. Boundary tolerance and violation conditions and can be set.

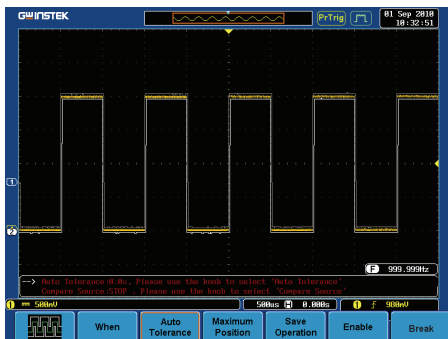

Choose the Go_NoGo application from the APP. menu. See page 88.

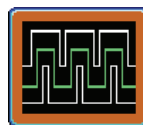

Go-NoGo Conditions

Select the Go-NoGo conditions (When) and actions when a Go-NoGo condition has been met (Violating).

1. Press *When* from the bottom menu and use the Variable knob to select the When condition.



When **Exit:** Sets the NoGo condition to when the input signal exceeds the limit boundary.

Enter: Sets the NoGo condition to when the input signal stays within the limit boundary.

2. Press *When* again to change the menu to *Violating*. Use the Variable knob to choose the action for when a violation occurs.

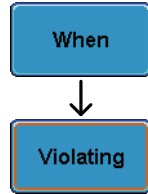

Violating Stop: The waveform will be frozen.

Stop_Beep: The waveform will be frozen and a beep will be output.

Continue: Ignore the violation.

Continue_Beep: Output a beep, but continue to monitor the signal.

Source

1. Press *Compare Source* from the bottom menu and use the Variable knob to select the source.



Source CH1, CH2, CH3, CH4

Tolerance Boundary

1. To set a tolerance, press *Compare Source* again to toggle the menu to *Auto Tolerance*. Use the Variable knob to choose the tolerance as a percentage.

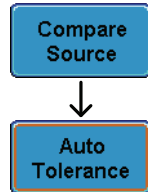

Violating 0.4% ~ 40% (.4% steps)

Note If a tolerance is set, the maximum and minimum boundary is reset as the tolerance boundary.

Maximum and Minimum

1. To set a maximum and minimum boundary, press *Minimum Position* from the bottom menu and use the Variable knob to select the absolute minimum position.



Position Voltage division range

2. Press *Minimum Position* again to toggle the menu to Maximum Position. Choose the maximum position.

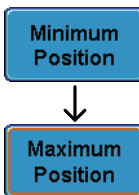

Position Voltage division range

Note If a maximum and minimum boundary is set, the tolerance will be disabled.

Save boundary limits

1. Select a *Maximum Position* or a *Tolerance* from the lower menu.
2. To save the Go-NoGo test parameters, press *Save Operation*. The Maximum position will be saved to R1. The tolerance waveforms will be saved to R1 and R2.
3. If a *Maximum Position* was saved, repeat the save procedure for *Minimum Position*. The Minimum position waveform will be saved to R2.



Start Go-NoGo

Press *Enable* to start the Go-NoGo test. The Enable button will change to Disable. Pressing *Disable* will stop the Go-NoGo test and toggle the button back to Enable.

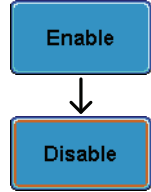

Exit the Application

To exit the application, press *Break*.



Using the Go-NoGo Output

To output the Go-NoGo results to an external device, the Go-NoGo rear panel terminal (open collector) can be used. The Go-NoGo terminal will output a 5Vpp a positive pulse each time a NoGo violation has occurred for a minimum of 10us.



The line out socket can also be used to connect directly to a buzzer.

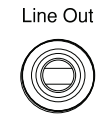

Timing diagram

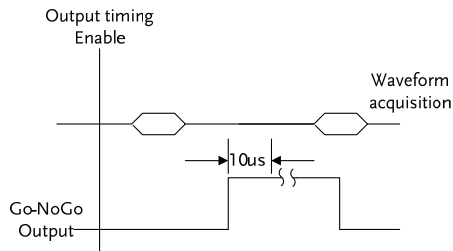

When a No-Go violation occurs the Go-NoGo output will go from a low level to a high level for a minimum of 10us.

Circuit diagram

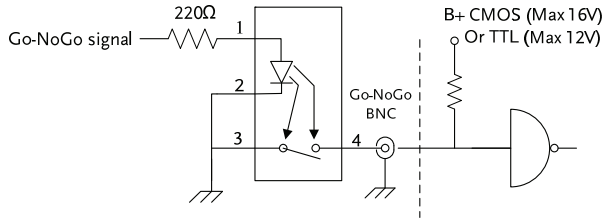

Power Analysis

Power analysis provides automatic measurement for a number of advanced measurement types such as power quality, harmonics, ripple and deskew. The Power analysis software is an optional software module. The GDS-3000 includes a 1 month trial. To install the optional software module or the limited time trial, please see page 193. Please see the Power Analysis manual for more details on using the power analysis software.

Power Analysis Overview

Power Quality	Power quality measures the power of a signal by compensating the current that leads.
Harmonics	The harmonics function shows signal harmonics up to the 40th harmonic. Harmonic tests can be user defined and common harmonic standards such as IEC 61000-3-2 can also be tested for.
Ripple	The ripple function calculates the ripple and noise of the waveform.

Serial Bus

The serial bus trigger and decode software includes support for 3 common serial interfaces, SPI, UART and I²C. Each interface is fully configurable to accommodate a wide range of protocol variation. Up to two different UART or I²C buses can be used at the same time. Only 1 SPI bus can be used at a time.

Each input can be displayed as binary or hexadecimal. An event table can also be created to aid in debugging.

Note that the Serial bus trigger and decode software is an optional extra. An activation key is required to activate the software. A month trial demonstration is also available. For details please see page 193. Please see the Serial Bus Decode manual for more details on using the serial bus software.

Serial Bus Overview

UART	Universal Asynchronous Receiver Transmitter. The UART bus is able to accommodate a wide range of various common UART serial communications. The UART serial bus software is suitable for a number of RS-232 protocol variants.
Inputs	Tx, Rx, Polarity
Threshold	Tx, Rx ($\pm 10V$)
Configuration	Baud Rate, Data Bits, Parity, Packets

I ² C	Inter Integrated Circuit is a two line serial data interface with a serial data line (SDA) and serial clock line (SCL). The R/W bit can be configured.
Inputs	SCLK, SDA
Threshold	SCLK, SDA ($\pm 10V$)
Configuration	Read, Write in address

SPI	The SPI (Serial Peripheral Interface) bus is fully configurable to accommodate the wide variety of SPI interfaces.
Inputs	SCLK, SS, MOSI, MISO
Threshold	SCLK, SS, MOSI, MISO ($\pm 10V$)
Configuration	SCLK edge, SS logic level, MOSI logic level, MISO logic level, word size, bit order

C ONFIGURATION

Acquisition.....	101
Select Acquisition Mode.....	101
Show Waveform in XY Mode.....	103
Set the Sampling Mode.....	105
Real time vs Equivalent Time Sampling Mode.....	106
Display.....	108
Display Waveform as Dots or Vectors	108
Set the Level of Persistence	109
Set the Intensity Level	109
Set the Waveform Intensity Type	111
Select Display Graticule	112
Freeze the Waveform (Run/Stop).....	113
Turn Off Menu.....	113
Horizontal View	114
Move Waveform Position Horizontally.....	114
Select Horizontal Scale	115
Select Waveform Update Mode	116
Zoom Waveform Horizontally	117
Vertical View (Channel)	119
Move Waveform Position Vertically	119
Select Vertical Scale	119
Select Coupling Mode.....	120
Set the Impedance.....	121
Invert Waveform Vertically	121
Limit Bandwidth.....	122
Expand by Ground/Center.....	123
Select Probe Type	124
Select Probe Attenuation Level.....	124
Set the Deskew	125

Trigger	126
Trigger Type Overview	126
Trigger Parameter Overview	128
Setup Holdoff Level	132
Setup Trigger Mode	133
Using the Edge Trigger	133
Using Advanced Delay Trigger	135
Using Pulse Width Trigger.....	136
Using Video Trigger	138
Pulse Runt trigger.....	139
Using Rise and Fall Trigger	141
System Info / Language / Clock.....	143
Select Menu Language.....	143
View System Information	143
Erase Memory	144
Set the Buzzer Volume.....	145
Set Date and Time	145

Acquisition

The Acquisition process samples the analog input signals and converts them into digital format for internal processing.

Select Acquisition Mode

Background	The acquisition mode determines how the samples are used to reconstruct a waveform.
Sample	The first sample in each acquisition (bucket) is used. This is the default acquisition mode.
Peak detect	Only the minimum and maximum value pairs for each acquisition interval (bucket) are used. This mode is useful for catching abnormal glitches in the signal.
Hi Resolution	The average of each acquisition (bucket) is used. This creates higher accuracies whilst reducing high frequency noise.
Average	Multiple acquired data is averaged. This mode is useful for drawing a noise-free waveform. To select the average number, use the Variable knob. Average number: 2, 4, 8, 16, 32, 64, 128, 256

Panel operation 1. Press the *Acquire* key.



- To set the Acquisition mode, press *Mode* on the on the bottom menu.



- Select an acquisition mode from the side menu.

Mode	Sample, Peak Detect, Hi Resolution, Average
Average sample	2, 4, 8, 16, 32, 64, 128, 256

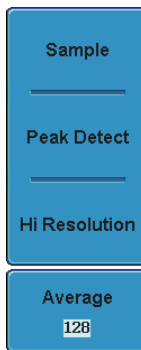

Example

Sample

Peak Detect

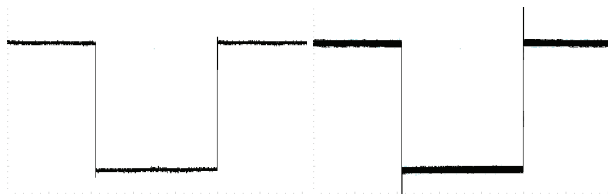

High Resolution

Average (256 times)

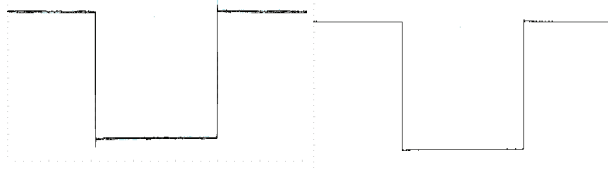



Show Waveform in XY Mode

Background The XY mode maps the voltage of channel 1 or channel 3 to the voltage of channel 2 or 4. This mode is useful for observing the phase relationship between waveforms.

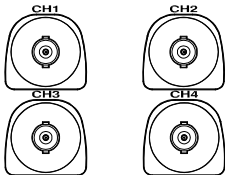
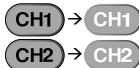
Connection

1. Connect the signals to Channel 1 (X-axis) and Channel 2 (Y-axis) or Channel 3 (X2-axis) and Channel 4 (Y2-axis).
 
2. Make sure a channel pair is active (CH1&CH2 or CH3&CH4). Press the Channel key if necessary. A channel is active if the channel key is lit.
 

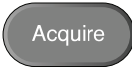
Panel operation

1. Press the *Acquire* menu key.
 
2. Press *XY* from the bottom menu.
 
3. Choose *Triggered XY* from the side menu.
 

X-Y mode is split into two windows. The top window shows the signals over the full time range. The bottom window shows XY mode.

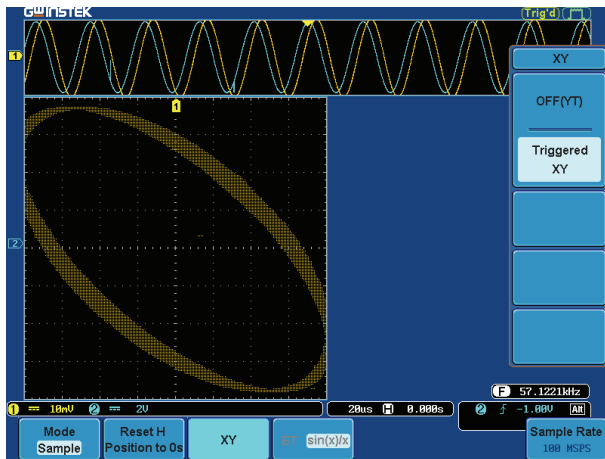

To move the X Y waveform position, use the vertical position knob: Channel 1 knob moves the X Y waveform horizontally, Channel 2 knob moves the X Y waveform vertically.

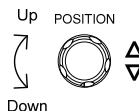

The horizontal position knob and Time/Div knob can still be used under the XY mode.

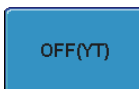

Turn off XY mode To turn off XY mode, choose *OFF (YT)* mode.



XY mode Cursors can be used with XY mode. See the Cursor chapter for details.

Set the Sampling Mode

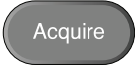
Background The GDS-3000 has two types of sampling modes: ET (Equivalent Time) and Sin(x)/x interpolation. Equivalent time sampling is able to achieve a sample rate of 100GSa/s when sampling periodic waveforms. Sin(x)/x interpolation uses curves to join each sampled point to give an accurate representation of a signal between sampled points.

- Panel operation**
1. Press the *Acquire* key. 
 2. Press the *ET/sin(x)/x* key on the bottom menu to toggle between equivalent time sampling (ET) and sin(x)/x interpolation. 

The sampling rate will be shown on the bottom right-hand corner

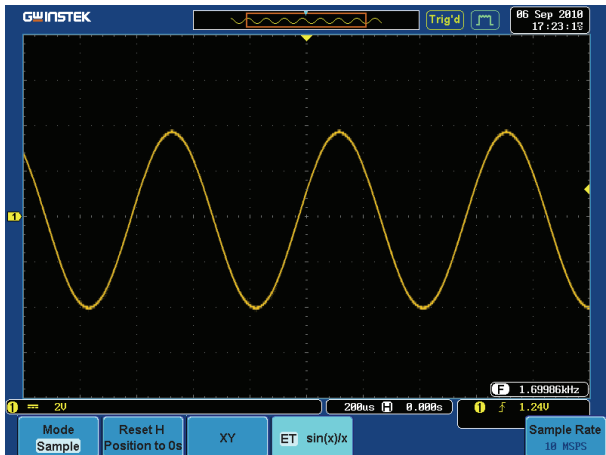

Real time vs Equivalent Time Sampling Mode

Background The sampling mode on the GDS-3000 can be switched between two sampling modes: Real-time and Equivalent-time. The number of active channels in operation will determine the sampling rate of the DSO. The sampling rate and mode depends on the number of active channels and whether the oscilloscope model has 2 or 4 channels.

Parameter	Real-time sampling	One sample of data is used to reconstruct a single waveform. Short-time events might get lost if the sampling rate gets too high. This mode is used when the sampling rate is relatively low.
	Equivalent-time sampling	Sampled data is accumulated a number of times to reconstruct a single waveform. This increases the sampling rate, but can only be used for repetitive signals. This mode is used when the sampling rate becomes higher.

Real-time Vs. Equivalent-time

Sampling rate by number of active channels

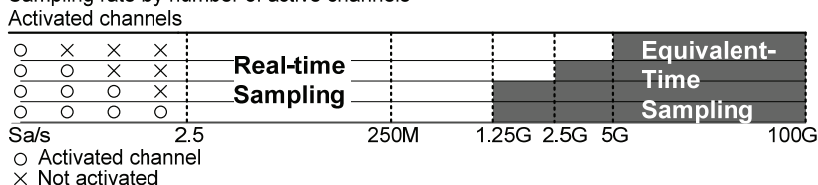

Single channel sampling rate for 2 channel models

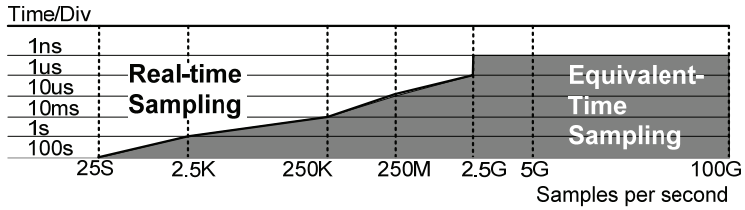

Single channel sampling rate for 4 channel models

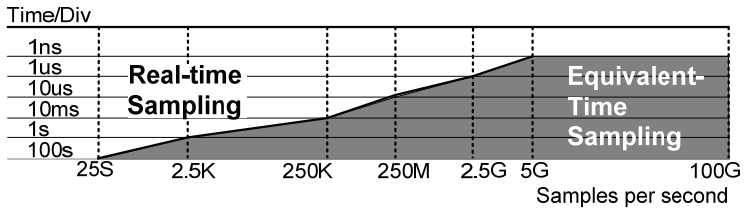

Display

The Display menu defines how the waveforms and parameters appear on the main LCD display.

Display Waveform as Dots or Vectors

Background When the waveform is displayed on screen, it can be displayed as dots or vectors.

Panel operation 1. Press the *Display* menu key.

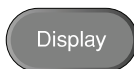

2. Press *Dot Vector* to toggle between Dot and Vector mode.

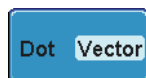

Range	Dots	Only the sampled dots are displayed.
	Vectors	Both the sampled dots and the connecting line are displayed.

Example:

Vectors (square wave)

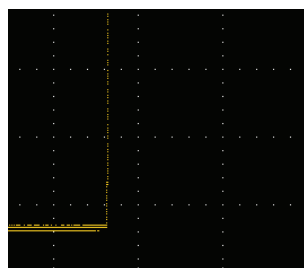

Dots (square wave)



Set the Level of Persistence

Background The persistence function allows the GDS-3000 to mimic the trace of a traditional analog oscilloscope. A waveform trace can be configured to “persist” for designated amount of time.

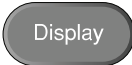
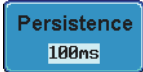
Panel operation

1. Press the *Display* menu key. 
2. To set the persistence time, press the *Persistence* menu button on the bottom bezel. 
3. Use the variable knob to select a persistence time. 

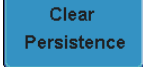

Time 100ms~10s, Infinite

Clear To clear persistence, press *Clear Persistence*. 

Set the Intensity Level

Background The intensity level of a signal can also be set to mimic the intensity of an analog oscilloscope by setting the digital intensity level.

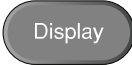
Panel operation

1. Press the *Display* menu key. 
2. Press *Intensity* from the bottom menu. 

Waveform Intensity

- To set the waveform intensity, press *Waveform Intensity* and edit the intensity.

Range 0~100%

Graticule Intensity

- To set the graticule intensity, press *Graticule Intensity* from the side menu and edit the intensity value.

Range 10~100%

Example

Waveform Intensity 0%

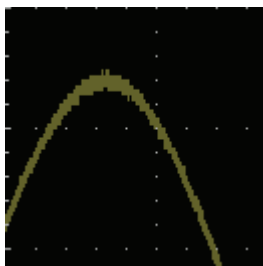

Waveform Intensity 100%

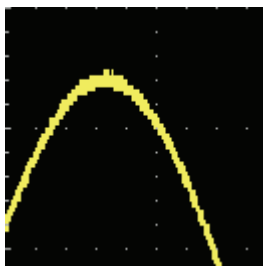

Graticule Intensity 10%

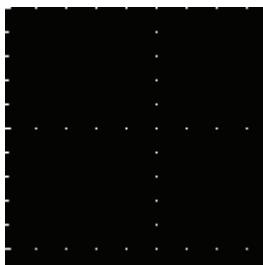

Graticule Intensity 100%



Set the Waveform Intensity Type

Background The intensity gradient of a signal can be set to grayscale or color. If intensity is set to color, the intensity gradient is analogous to a thermal color gradient where high intensity areas are colored red and low intensity areas are colored blue.

Panel operation 1. Press the *Display* menu key.

A gray, rounded rectangular button with the word "Display" in white text.

2. Press *Waveform* from the bottom menu to toggle the intensity type.

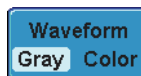

Range Gray, Color

Example

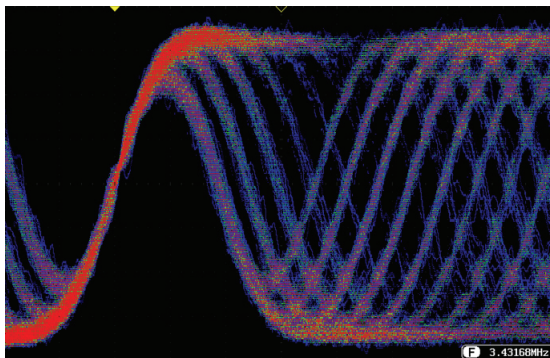

Select Display Graticule

Panel operation 1. Press the *Display* menu key.

A grey, rounded rectangular button with the word "Display" in white text.

2. Press *Graticule* from the bottom menu.

A blue rectangular button with rounded corners and a thin black border, containing the word "Graticule" in white text.

3. From the side menu choose the graticule display type.



Full: Shows the full grid; X and Y axis for each division.



Grid: Show the full grid sans the X and Y axis.



Cross Hair: Shows only the center X and Y frame.



Frame: Shows only the outer frame.

Freeze the Waveform (Run/Stop)

For more details about Run/Stop mode, see page 62.

- Panel operation
1. Press the *Run/Stop* key. To unfreeze the waveform, press the *Run/Stop* key again.



2. The waveform and the trigger freezes. The trigger indicator on the top right of the display shows Stop.



Turn Off Menu

- Panel operation
1. Press the *Menu Off* key below the side menu keys to reduce a menu. The menu key needs to be pressed each time to reduce one menu.

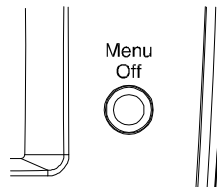

See page 33 for more information.

Horizontal View

This section describes how to set the horizontal scale, position, and waveform display mode.

Move Waveform Position Horizontally

Panel operation The horizontal position knob moves the waveform left/right.



As the waveform moves, a position indicator on the top of the display indicates the horizontal position of the waveform in memory.

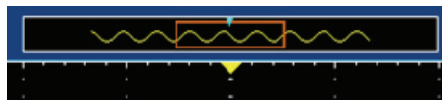

Reset horizontal position 1. To reset the horizontal position, press the Acquire key.



2. Next press *Reset H Position to 0s* from the bottom menu.



Run mode In Run mode, the memory bar keeps its relative position in the memory since the entire memory is continuously captured and updated.

Select Horizontal Scale

Select horizontal scale To select the timebase (scale), turn the TIME/DIV knob; left (slow) or right (fast).

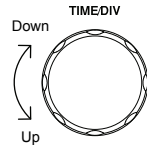

Range 1ns/div ~ 100s/div, 1-2-5 increment

The timebase indicator updates as the TIME/DIV is adjusted.

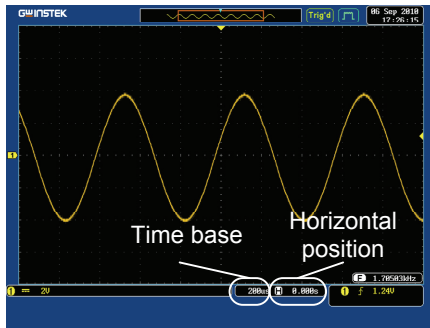

Run mode In Run mode, the memory bar and waveform size keep their proportion. When the time base becomes slower, roll mode is activated.

Stop mode In Stop mode, the waveform size changes according to the scale.

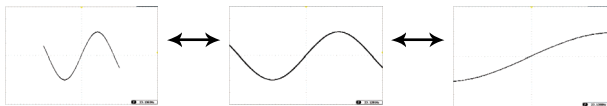

Select Waveform Update Mode

Background	The display update mode is switched automatically or manually according to the timebase and trigger.
Normal	<p>Updates the whole displayed waveform at once. Automatically selected when the timebase (sampling rate) is fast.</p> <p>Timebase $\leq 50\text{ms/div}$ ($\geq 500\text{Sa/s}$)</p> <p>Trigger all modes</p>
Roll mode	<p>Roll Updates and moves the waveform gradually from the right side of the display to the left. Automatically selected when the timebase (sampling rate) is slow.</p> <p>Timebase $\geq 100\text{ms/div}$ ($\leq 25\text{MSPS}$)</p> <p>Trigger all modes</p>

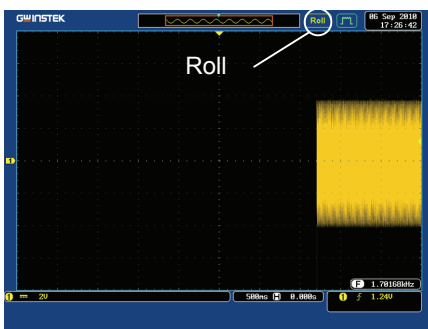

Select Roll mode manually 1. Press the *Trigger Menu* key.



2. Press *Mode* from the bottom menu and select *Auto (Untriggered Roll)* from the side menu.



Zoom Waveform Horizontally

Background When in Zoom mode the screen is split into 2 sections. The top of the display shows the full record length, with the bottom of the screen showing the normal view.

Panel operation 1. Press the *Zoom* key.

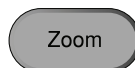

2. The Zoom mode screen appears.

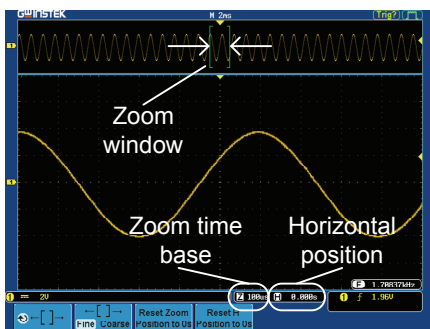

Horizontal Navigation

To scroll the waveform left or right, use the *Horizontal Position* knob.



To reset the horizontal position, press *Reset H Position to 0s*.



Zoom

To increase the zoom range, use the *TIME/DIV* knob.

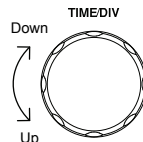

The zoom time base (Z) at the bottom of the screen will change accordingly.



Move the zoom window

Use the *Variable* knob to pan the zoom window horizontally.

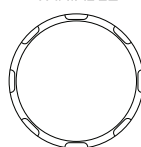

To reset the Zoom position, press *Reset Zoom Position to 0s*.



Scroll Sensitivity

To alter the scrolling sensitivity of the Zoom Window, press the $\leftarrow[\]\rightarrow$ key to toggle the scrolling sensitivity.

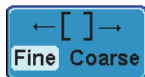

Sensitivity Fine, Coarse

Exit

To go back to the original view, press the *Zoom* key again.



Vertical View (Channel)

This section describes how to set the vertical scale, position, and coupling mode.

Move Waveform Position Vertically

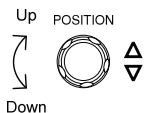
- | | | |
|-----------------|--|---|
| Panel operation | <ol style="list-style-type: none"> To move the waveform up or down, turn the <i>vertical position</i> knob for each channel. As the waveform moves, the vertical position of the cursor appears at the bottom half of the display. |  |
|-----------------|--|---|

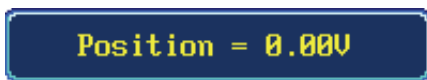

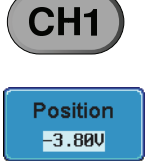
- | | | |
|----------------|---|---|
| Reset Position | <ol style="list-style-type: none"> To reset the vertical position, press the <i>channel</i> key for the signal. Press <i>Position</i>. The position voltage will reset to 0 volts/amps. |  |
|----------------|---|---|

Run/Stop mode The waveform can be moved vertically in both Run and Stop mode.

Select Vertical Scale

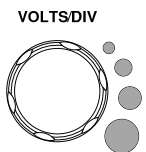
- | | | |
|-----------------|--|---|
| Panel operation | <p>To change the vertical scale, turn the VOLTS/DIV knob; left (down) or right (up).</p> |  |
|-----------------|--|---|

The vertical scale indicator on the bottom left of the display changes accordingly for the specific channel.

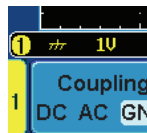

Range 2mV/div ~ 1V/div (50Ω/75Ω),
 2mV/div ~ 5V/div (1MΩ). 1-2-5 increments

Stop mode In Stop mode, the vertical scale setting can be changed but the waveform shape stays the same.

Select Coupling Mode

Panel operation 1. Press a *channel* key.



2. Press *Coupling* repeatedly to toggle the coupling mode for the chosen channel.



Range

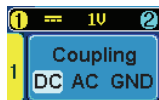

DC coupling mode. The whole portion (AC and DC) of the signal appears on the display.

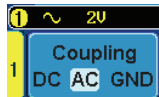

AC coupling mode. Only the AC portion of the signal appears on the display. This mode is useful for observing AC waveforms mixed with DC signals.

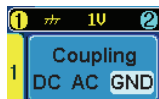

Ground coupling mode. The display shows only the zero voltage level as a horizontal line. This mode is useful for measuring the signal voltage with respect to the ground level.

Example Observing the AC portion of the waveform using AC coupling

DC coupling

AC coupling

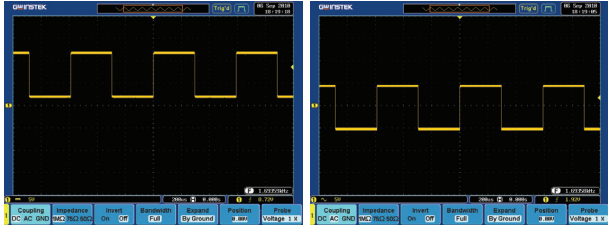

Set the Impedance

Panel operation 1. Press the *Channel* key.



2. Press *Impedance* repeatedly to toggle between the impedance settings.

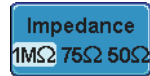

Impedance 1MΩ, 75Ω, 50Ω

Invert Waveform Vertically

Panel operation 1. Press the *Channel* key.



2. Repeatedly press *Invert* to toggle Invert On or Off.



Limit Bandwidth

Background Bandwidth limitation puts the input signal into a selected bandwidth filter.

This function is useful for cutting out high frequency noise to see a clear waveform shape.

The bandwidth filters available are dependent on the bandwidth of the oscilloscope model.

Panel operation 1. Press the *Channel* key.



2. Press *Bandwidth* from the bottom menu.



3. Choose a bandwidth from the side menu (depending on the bandwidth of the oscilloscope).

- | | |
|-------|-------------------------------------|
| Range | 150MHz: Full, 20MHz |
| | 250MHz: Full, 20MHz, 100MHz |
| | 350MHz: Full, 20MHz, 100MHz, 200MHz |

Example

BW Full

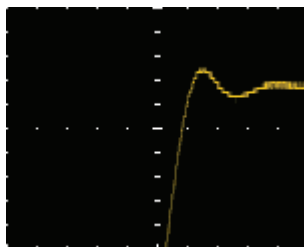

BW Limit 20MHz

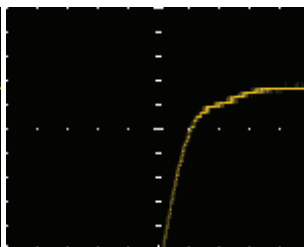

Expand by Ground/Center

Background When the voltage scale is changed, the Expand function designates whether the signal expands from the center of the signal or from the signal ground level. Expand by center can be used to easily see if a signal has a voltage bias. Expand by ground is the default setting.

Panel operation 1. Press a *channel* key.



2. Press *Expand* repeatedly to toggle between expand *By Ground* and *Center*.



Range By Ground, By Center

Example If the vertical scale is changed when the Expand function is set to ground, the signal will expand from the ground level*. The ground level does not change when the vertical scale is changed.

If the vertical scale is changed when the Expand function is set to center, the signal will expand from the center of the signal. The ground level will suit to match the signal position.

*Or from the upper or lower edge of the screen if the ground level is off screen.

Expand by Ground

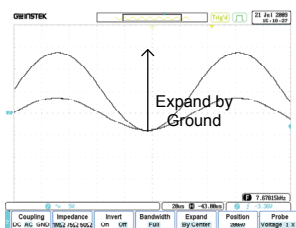

Expand by Center

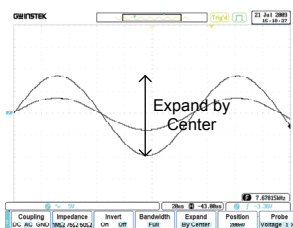

Select Probe Type

Background A signal probe can be set to voltage or current.

Panel operation 1. Press the *Channel* key.



2. Press *Probe* from the bottom menu.



3. Press the *Voltage/Current* softkey to toggle between voltage and current.

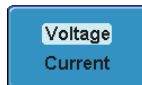

Select Probe Attenuation Level

Background A signal probe has an attenuation switch to lower the original DUT signal level to the oscilloscope input range, if necessary. The probe attenuation selection adjusts the vertical scale so that the voltage level on the display reflects the real value on a DUT.

Panel operation 1. Press the *Channel* key.



2. Press *Probe* from the bottom menu.

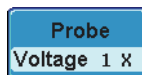

3. Press *Attenuation* on the side menu and use the variable knob to set the attenuation.



Alternatively, press *Set to 10X*.

Range 1mX ~1kX (1-2-5 step)

Note The attenuation factor adds no influence on the real signal. It just changes the voltage/current scale on the display.

Set the Deskew

Background The deskew function is used to compensate for the propagation delay between the oscilloscope and the probe.

- Panel operation** 1. Press one of the *Channel* keys.



2. Press *Probe* from the bottom menu.



3. Press *Deskew* on the side menu and use the variable knob to set the deskew time.

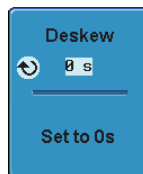

Alternatively, press *Set to 0s* to reset the deskew time.

Range -50ns~50ns, 10ps increments

4. Repeat the procedure for another channel if necessary.

Trigger

The trigger configures the conditions for when the GDS-3000 captures a waveform.

Trigger Type Overview

Edge The edge trigger is the simplest trigger type. An edge trigger triggers when the signal crosses an amplitude threshold with either a positive or negative slope.

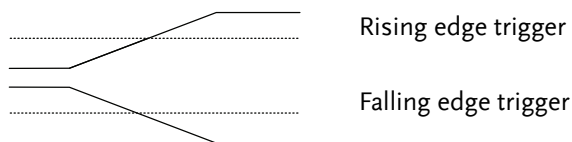

Delay The Delay trigger works in tandem with the edge trigger, by waiting for a specified time or number of events before the edge trigger starts. This method allows pinpointing a location in a long series of trigger events.

Note: when using the delay trigger, the edge trigger source can be any one of the channel inputs, the EXT input or the AC line.

Delay trigger example (by event)

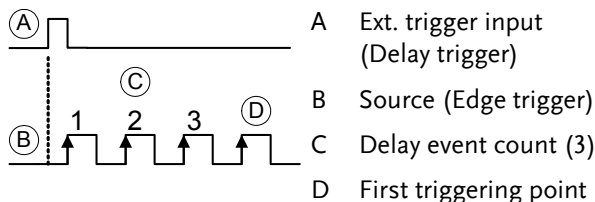

Delay trigger example (by time)

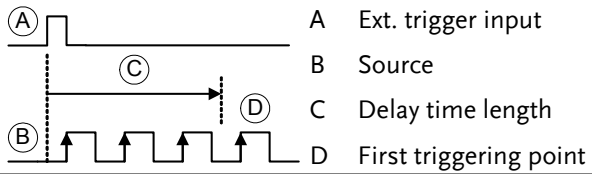

Pulse Width Triggers when the pulse width of the signal is less than, equal, not equal or greater than a specified pulse width.



Video Extracts a sync pulse from a video format signal, and triggers on a specific line or field.

Pulse and Runt Triggers on a "runt". A runt is a pulse that passes a specified threshold but fails to pass a second threshold. Both positive and negative runts can be detected.

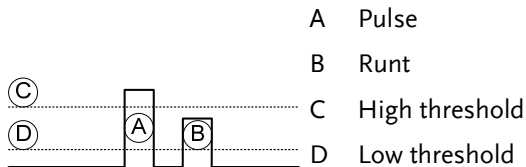

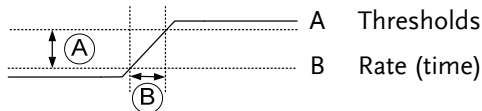

Rise and Fall Trigger on rising and or falling edges, below or over a specified rate. The threshold can also be specified.



Trigger Parameter Overview

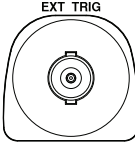

All the following parameters are common for all the trigger types unless stated otherwise.



Trigger source	CH1 ~ 4	Channel 1 ~ 4 input signals	
	EXT	External trigger input signal	
	AC Line	AC mains signal	
	Alternate	Alternate between channel sources for the trigger source.	
	EXT Probe	Probe trigger source. Set the probe as either current or voltage.	

Trigger mode	Auto (un-triggered roll)	The GDS-3000 generates an internal trigger if there is no trigger event, to make sure waveforms are constantly updated regardless of trigger events. Select this mode especially when viewing rolling waveforms at slower timebases.	
	Normal	The GDS-3000 acquires a waveform only when a trigger event occurs.	
	Single	The GDS-3000 acquires a waveform once when a trigger event occurs, then stops acquiring. Press the Single key to acquire a waveform again.	

Coupling	DC	DC coupling.
----------	----	--------------



(Edge, Delay)	AC	AC coupling. Blocks DC components from the trigger circuits.
	HF reject	High frequency filter above 50kHz
	LF reject	Low frequency filter below 50kHz
	Reject noise	DC coupling with low sensitivity to reject noise.

Slope (Edge, Delay, Rise & Fall)		Trigger on a rising edge.
		Trigger on a falling edge.
		Don't care. (Rise & Fall trigger type only)



Trigger Level (Edge, Delay)	Level	Adjusts the trigger manually using the Trigger LEVEL knob.	
	Set to TTL 1.4V	Sets the trigger level to 1.4V, suitable for triggering on TTL signals.	
	Set to ECL - 1.3V	Sets the trigger to -1.3V. This is suitable for ECL circuits.	
	Set to 50%	Sets the trigger level to 50% of the waveform amplitude.	

Holdoff	Holdoff	Sets the holdoff time.
	Set to Minimum	Set the holdoff time to the minimum.

Delay (Delay)	Time	Sets the delay time (10ns ~ 10s) between the trigger event and the real trigger timing.
	Event	Sets the number of events (1 ~ 65535) passed after the trigger event, until the real trigger timing.

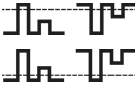
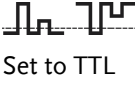
	Set to Minimum	Sets the source trigger to the minimum time.
When (Pulse Width)	Sets the pulse width (4ns ~ 10s) and the triggering condition.	
	>	Longer than = Equal to
	<	Shorter than ≠ Not equal to
Threshold (Pulse Width)	Sets the amplitude threshold level for the pulse widths.	
	Threshold	-10V ~ +10V, user-set level
	Set to TTL	1.4V
	Set to ECL	-1.3V
	Set to 50%	Sets the threshold to 50%
Standard (Video)	NTSC	National Television System Committee
	PAL	Phase Alternate by Line
	SECAM	SEquential Couleour A Memoire
	EDTV	420P (NTSC) (576p PAL)
	HDTV	720P, 1080i, 1080P signals
Polarity (Edge, Video)		Positive polarity (triggered on the high to low transition)
		Negative polarity (triggered on the low to high transition)
Trigger On (Video)	Selects the trigger point in the video signal.	
	Field	1 or 2 or all.
	Line	1~263 for NTSC, 1~313 for PAL/SECAM, 1~ 525/625 for EDTV, 1~563/750/1125 for HDTV or all.

Threshold  Sets the upper threshold limit.
(Pulse Runt)  Sets the lower threshold limit.
Set to TTL 1.4V
Set to ECL -1.3V

Threshold  **High** Sets the High threshold.
(Rise & Fall)  **Low** Sets the Low threshold.
Set to TTL 1.4V
Set to ECL -1.3V

Setup Holdoff Level

Background

The holdoff function defines the waiting period before the GDS-3000 starts triggering again after a trigger point. The holdoff function ensures a stable display if there are a number of points in a periodic waveform that can be triggered. Holdoff applies to all the triggering types.

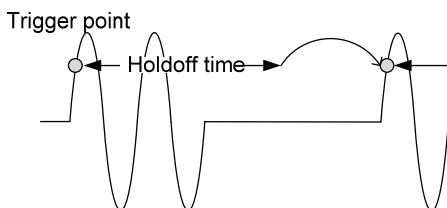

Panel operation

1. Press the trigger *Menu* key.



2. To set the Holdoff time, press the *Holdoff* (or *Mode/Holdoff*) menu button on the bottom bezel.



3. Use the side menu to set the Holdoff time.



Range 10ns~10s



Pressing *Set to Minimum* sets the Holdoff time to the minimum, 10ns.







Note: The holdoff function is automatically disabled when the waveform update mode is in roll mode (page116).

Setup Trigger Mode

Background The trigger mode can be set to Normal or Auto (untriggered roll). The triggering mode applies to all the trigger types. See page 116.

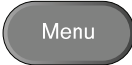
- Panel operation**
1. Press the Trigger menu key. 
 2. Press *Mode* from the bottom menu to change the triggering mode. 
 3. Use the side panel to select *Auto* or *Normal* triggering modes.
Range Auto, Normal

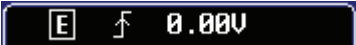
Using the Edge Trigger

- Panel operation**
1. Press the Trigger menu key. 
 2. Press *Type* from the lower bezel menu. 
 3. Select *Edge* from the side menu. The edge trigger indicator appears at the bottom of the display. 

From left: edge trigger, slope, trigger level
 4. Press *Source* to change the trigger source. 

5. Use the side menu to select the trigger source type.

Range Channel 1 ~ 4 (Alternate On/Off),
Line, EXT; Ext Probe
(Volt/Current), AC Line

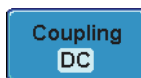
6. Press *Coupling* from the bottom bezel menu to select the trigger coupling or frequency filter settings.



7. Choose the coupling from the side menu.

Range DC, AC

8. Press *Reject* to toggle the rejection filter from the side menu.

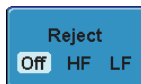

Range HF Reject, LF Reject, Off

9. Toggle *Noise Rejection* On or Off from the side menu.

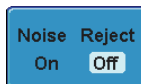

Range On, Off

10. From the bottom menu press *Slope* to toggle the slope type.



Range Rising edge, falling edge

11. To set the external trigger level, select *Level* from the bottom bezel menu.



12. Set the external trigger level using the side menu.

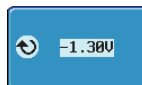

- Range 00.0V~ 5 screen divisions
- Set to TTL 1.4V
- Set to ECL -1.3V
- Set to 50%

Using Advanced Delay Trigger

Background The EXT trigger source is always used as the delay triggering source.

- Panel operation** 1. Press the trigger *Menu* key.



2. Press *Type* from the lower bezel menu.



3. Select *Delay* from the side menu. The delay + edge trigger indicator appears at the bottom of the display.



From left: edge trigger, slope, trigger level, delay + edge trigger

4. To set the delay press *Delay* from the bottom bezel.

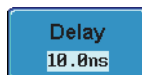

5. To Delay by Time, press *Time* from the side menu and set the delay time.

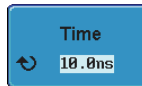

Range 10ns ~ 10s (by time)
 Set to minimum

6. To Delay by Event, press *Event* from the side menu and set the number of events.

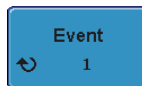

Range 1 ~ 65535 events
 Set to Minimum

Using Pulse Width Trigger

- Panel operation 1. Press the trigger *Menu* key.



2. Press the *Type* key from the lower bezel menu.



3. Select *Pulse Width* from the side menu. The pulse width trigger indicator appears at the bottom of the display.

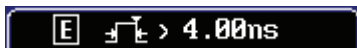

From left: edge, polarity, when

4. Press *Source* from the lower bezel.

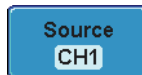

5. Use the side menu to select the pulse width trigger source.

Range Channel 1 ~ 4 (Alternate On/Off),
Line, EXT; Ext Probe
(Volt/Current), AC Line

6. Press *Polarity* to toggle the polarity type.



Range Positive (high to low transition)
Negative (low to high transition)

7. Press *When* from the lower bezel.

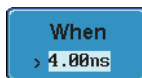

8. Then use the side menu to select the pulse width condition and width.

Condition > , < , = , ≠

Width 4ns ~ 10s



9. Press *Threshold* from the lower bezel to edit the pulse width threshold.





10. Use the side menu to set the threshold.

Range -10V~+10V
Set to TTL 1.4V
Set to ECL -1.3V
Set to 50%

Using Video Trigger

- Panel operation
1. Press the trigger *Menu* key.
 
 2. Press the *Type* key from the lower bezel menu.
 
 3. Select *Video* from the side menu. The video trigger indicator appears at the bottom of the display.
 



From left: channel, video standard, field, line
 4. Press *Source* from the lower bezel.
 
 5. Use the side menu to select the video trigger source.

Range Channel 1 ~ 4
 6. Press *Standard* on the bottom bezel.
 
 7. Use the side menu to select the video standard.

Range NTSC, PAL, SECAM, EDTV
(480P/576P), HDTV
(720P/1080i/1080P)
 8. Press *Trigger On* to edit the video field and line.
 

9. Use the side menu to select the field and line.

Field 1, 2, All

Video line NTSC: 1 ~ 262 (Even), 1 ~ 263 (Odd)
PAL/SECAM: 1 ~ 312 (Even),
1 ~ 313 (Odd),

EDTV(480P): 1~ 525, EDTV(576P):
1~ 625

HDTV(720P): 1~ 750, HDTV (1080i):
1 ~ 562 (even), 1~563 (odd), HDTV
(1080P): 1~1125, All

10. Press *Polarity* to toggle the polarity type.



Range positive, negative

Pulse Runt trigger

- Panel operation 1. Press the trigger *Menu* key.



2. Press the *Type* key from the lower bezel menu.



3. Select *Others* → *Pulse Runt* from the side menu. The Pulse and Runt indicator appears at the bottom of the display.

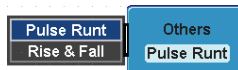

From left: Polarity, source, high/low threshold, threshold level

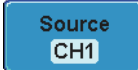
4. Press *Source* from the lower menu. 

5. Use the side menu to select a source.

Range Channel 1 ~ 4

6. Press *Polarity* to toggle the polarity. 

Range Rising edge, falling edge, either.

7. Press *When* from the lower menu. 

8. Then use the side menu to select the condition and width.

Condition > , < , = , ≠

Width 4ns ~ 10s

9. Press *Threshold* from the lower bezel to edit the threshold for each input source. 

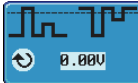
10. Use the side menu to set the upper threshold. 

Range -80V~80V
 Set to TTL 1.4V
 Set to ECL -1.3V
 Set to 50%

- Use the side menu to set the lower threshold.



- Range -80V~80V
- Set to TTL 1.4V
- Set to ECL -1.3V
- Set to 50%

Using Rise and Fall Trigger

- Panel operation 1. Press the *Menu* key.



- Press the *Type* key from the lower bezel menu.



- Select *Others* → *Rise and Fall* from the side menu. The Rise and Fall indicator appears at the bottom of the display.

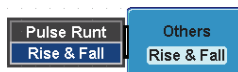

From left: rise and fall, source, high/low threshold, threshold level

- Press *Source* from the lower menu.

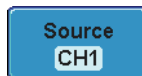

- Use the side menu to select a source.

- Range Channel 1 ~ 4

6. Press *Slope* from the bottom menu to toggle the slope.



Range Rising edge, falling edge, either

7. Press *When* from the lower menu.

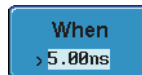

8. Then use the side menu to select the logic conditions and true or false status.

Condition $>$, $<$, $=$, \neq

Width 4ns ~ 10s

9. Press *Threshold* from the lower bezel to edit the threshold for each input source.



10. Use the side menu to set the threshold for the current input.

Range High: -80V~80V

Low: -80V~80V

Set to TTL 1.4V

Set to ECT -1.3V

System Info / Language / Clock

This section describes how to set the interface, beeper, language, time/date, and probe compensation signal.

Select Menu Language

Parameter The following is a list of language available by default. Language selection may differ according to the region to which the GDS-3000 is shipped.

- English
- Chinese (simplified)
- Korean
- Chinese (traditional)
- Japanese

Panel operation 1. Press the *Utility* key. 

2. Select the language from the side menu. 

Range English, Trad. Chinese, Simp. Chinese, Japanese, Korean.

View System Information

Panel operation 1. Press the *Utility* key. 

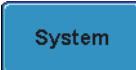
2. Press *System* from the lower menu. 

3. Press *System Info* from the side menu. A display panel will appear showing:



- Manufacturer name
- Model name
- Serial number
- Firmware version
- Manufacturer URL



Erase Memory

Background The Erase Memory function will erase all internal waveforms, setup files and labels from internal memory.

Erased items Waveform 1~20, Setting memory 1~20, Reference 1~4, Labels

- Panel operation** 1. Press the *Utility* key.



2. Press *System* from the lower menu.

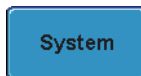

3. Press *Erase Memory* from the side menu.

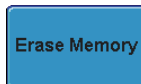

A message will prompt you to press Erase Memory again to confirm the process.

4. Press *Erase Memory*.

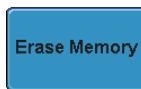

Set the Buzzer Volume

- Panel operation
1. Press the *Utility* key.



2. Press *System* from the lower menu.

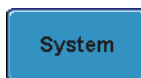

3. Press the buzzer icon on the side panel. Use the variable knob to set the volume.



Set Date and Time

- Panel operation/
parameter
1. Press the *Utility* key.



2. Press *Date & Time* on the lower menu.



- Set the *Year, Month, Day, Hour* and *Minute* from the side menu.

Year 2000 ~ 2037

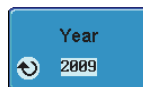

Month 1 ~ 12

Day 1 ~ 31



Hour 1~24

Minute 0~59

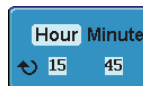

- Press *Save Now* from the side menu to save the date and time.



- Turn Off the display and turn it On again (power cycle).

POWER



- Make sure the date/time setting is correctly reflected at the top of the display.



SAVE/RECALL

File Format/Utility	148
Image File Format.....	148
Waveform File Format.....	148
Spreadsheet File Format.....	149
Setup File Format.....	150
Create/Edit file labels	152
Save	154
File Type/Source/Destination.....	154
Save Image	155
Save Image - Print Key.....	156
Save Waveform	157
Save Setup	159
Recall	161
File Type/Source/Destination.....	161
Recall Default Panel Setting.....	161
Recall Waveform	163
Recall Setup.....	164
Reference Waveforms	166
Recall and Display Reference Waveforms	166

File Format/Utility

Image File Format

Format	DSxxxx.bmp or DSxxxx.png
Contents	The current display image is 800 by 600 pixels. The background color can be inverted (Ink saver function). Each image file is numbered consecutively from DS0001 to DS9999.

Waveform File Format

Format	DSxxx.lsf, CH1~CH4.lsf	
	The LSF file format efficiently stores waveforms. This is the file format is used for storing and recalling waveforms that can be used for measurement with the GDS-3000 series.	
Waveform type	CH1 ~ 4	Input channel signal
	Math	Math operation result (page 83)
Storage location	Wave1 ~ Wave20	Waveform files stored to the internal memory. Stored waveforms can be copied to Ref. 1 ~ 4 to be viewed on the display. (W1 ~ W20 waveforms cannot be directly recalled on the display).

Ref 1~4 Reference waveforms stored in the internal memory, separate from W1 ~ W20. Reference waveforms (Ref 1 ~ 4) can be displayed directly onto the display with amplitude and frequency information. Ref 1~4 are useful for reference purposes. Other waveforms (LSF and W1~20) must be recalled to R1~4 before being displayed.

Contents: waveform data The waveform data can be used for detailed analysis. It consists of the horizontal and vertical data used by the waveform for the entire memory length.

Spreadsheet File Format

Format DSxxxx.csv (Comma-separated values format, can be opened in spreadsheet applications such as Microsoft Excel). CSV files cannot be recalled onto the GDS-3000 series of oscilloscopes.

Waveform type CH1 ~ 4 Input channel signal
Math Math operation result (page83)

Contents: waveform data Digital waveform data containing the channel information such as vertical and horizontal position of a signal for the entire memory length.

Contents: other data The following information is also included in the waveform file.

- Firmware version
- Horizontal mode
- Trigger level
- Vertical scale
- Vertical position
- Time of acquisition
- Memory length
- Vertical units
- Probe level
- Horizontal units

- Horizontal scale
- Horizontal position
- Time (of points)
- Horizontal scale
- Sampling period
- Channel



Setup File Format

Format	DSxxxx.set (proprietary format)	
	The setup file saves or recalls the following settings.	
Contents	Acquire	<ul style="list-style-type: none"> • Mode • XY • Sample mode • Delay • Sample rate
	Display	<ul style="list-style-type: none"> • Mode • Persistence • Waveform intensity • Graticule intensity • Waveform visuals • Graticule
	Channel	<ul style="list-style-type: none"> • Scale • Channel • Coupling • Impedance • Invert • Bandwidth • Expand • Position • Probe • Probe attenuation • Deskew
	Cursor	<ul style="list-style-type: none"> • Horizontal cursor • Vertical cursor
	Measure	<ul style="list-style-type: none"> • Source • Gating • Display
	Horizontal	<ul style="list-style-type: none"> • Scale

Math	<ul style="list-style-type: none">• Source1• Operator• Source2	<ul style="list-style-type: none">• Position• Unit/Div• Math Off
Trigger	<ul style="list-style-type: none">• Type• Source• Coupling• Alternate• Rejection	<ul style="list-style-type: none">• Noise Rejection• Slope• Level• Mode• Holdoff
Utility	<ul style="list-style-type: none">• Language• Volume• Print key	<ul style="list-style-type: none">• Ink Saver• USB device• USB class
Save/ recall	<ul style="list-style-type: none">• Image file format	<ul style="list-style-type: none">• Data file format

Create/Edit file labels

Format Reference files and Setup files stored in internal memory can have individual labels set. The labels are used on the reference waveform and setup file icons.

- Panel operation**
1. Press the *Save/Recall* key from the front panel. 
 2. Press *Edit File Label* from the bottom menu. 
 3. Press *Label For* to choose a Reference or Setup file. 

Label For Ref1~4, Set1~20
 4. To choose a preset label, Press *User Preset* from the side menu and choose a label. 

Labels ACK, AD0, ANALOG, BIT, CAS, CLK, CLOCK, CLR, COUNT, DATA, DTACK, ENABLE, HALT, INT, IN, IRQ, LATCH, LOAD, NMI

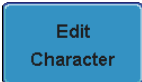
- Edit label**
1. Press *Edit Character* to edit the current label. 

- The Edit Label window appears.



- Use the Variable knob to highlight a character.

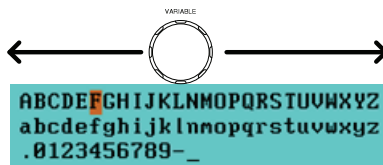

Press *Enter Character* to select a number or letter.

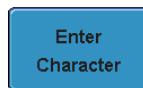

Press *Back Space* to delete a character.



Press *Editing Completed* to create the new label and return to the previous menu.

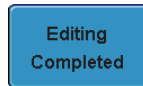

Cancel

Press *Cancel* to cancel the operation and return to the previous menu.



Save

File Type/Source/Destination

Item	Source	Destination
Panel setup (DSxxxx.set)	<ul style="list-style-type: none"> • Front panel settings 	<ul style="list-style-type: none"> • Internal memory: Set1 ~ Set20 • File system: Disk, USB
Waveform data (DSxxxx.csv) (DSxxxx.lsf) (CH1~4.lsf)*	<ul style="list-style-type: none"> • Channel 1 ~ 4 • Math operation result • Reference waveform Ref1~4 • All displayed waveforms 	<ul style="list-style-type: none"> • Internal memory: Reference waveform Ref1~4, Wave1 ~ Wave20 • File system: Disk, USB
Display image (DSxxxx.bmp) (DSxxxx.png)	<ul style="list-style-type: none"> • Display image 	<ul style="list-style-type: none"> • File system: Disk, USB

*Stored in ALLXXX directories when All Displayed waveforms are saved

Save Image

Panel operation

- To save to USB, connect a USB drive to the front or rear panel USB port. If a USB drive is not connected, images will be saved to the internal memory.
Note: Only one host connection, front or rear, is allowed at a time.

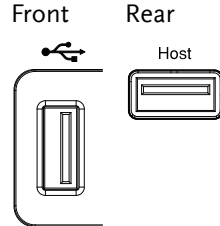

- Press the *Save/Recall* key from the front panel.



- Press *Save Image* from the bottom menu.



- Press *File Format* to choose PNG or BMP file types.



Range DSxxxx.bmp, DSxxxx.png

- Press *Ink Saver* to toggle Ink Saver On or Off.

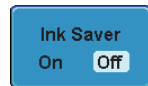

Ink Saver On

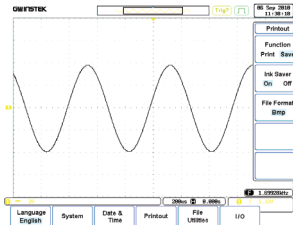

Ink Saver Off

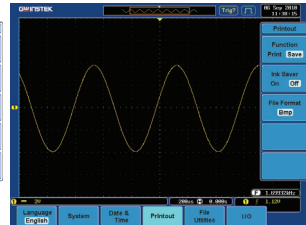

6. Press *Save Now* from the side menu to save the display as an image file.



Image save to USB :/DS0006.BMP completed!

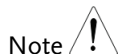

Note

The file will not be saved if the power is turned Off or the USB drive is taken out before the message ends.

USB file utility

To edit the USB flash drive contents (create/ delete/ rename files and folders) or to edit the default file path, press *File Utilities* from the side menu. See page 167 for details.



Save Image - Print Key

Background

The Print key can be assigned to Print or to Save. When assigned to Save, pressing the Print key will save a screen image to USB.

Panel operation

1. Connect a USB drive to the front or rear panel USB port.
Note: Only one host connection, front or rear, is allowed at a time.

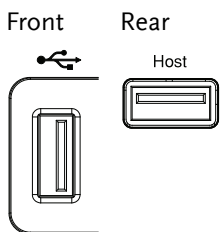

2. Press the *Utility* key.



3. Press *Printout* from the bottom menu.



- On the side menu, press *Function* repeatedly to select *Save*.



The *Save* led on the screen bezel will be lit when the printout function is set to *Save*.



- Press the *Print* key to save to USB



Ink Saver

To invert the color for the saved or printed display image, press *Ink Saver* repeatedly to toggle *Ink Saver On* or *Off* from the side menu.



Ink Saver On (Inverted)

Ink Saver Off (Normal)

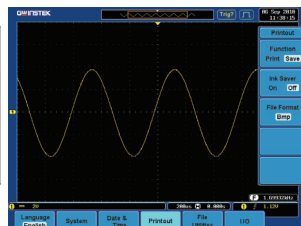
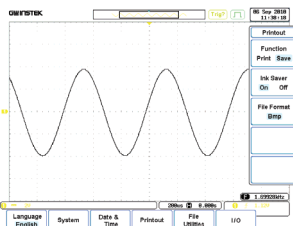

Save Waveform

Panel operation

- (For saving to an external USB flash drive) Connect the drive to the front or rear panel USB port.
Note: Only one host connection, front or rear, is allowed at a time.

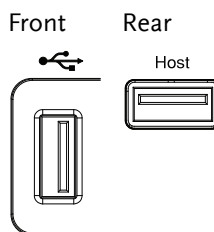

- Press the *Save/Recall* key from the front panel.



3. Press *Save Waveform* from the bottom menu.



4. Choose the *From* waveform on the side menu.



Source CH1~4, Math, Ref1~4, All displayed

5. Press *To* (internal memory) or *To File* and choose a destination to save.



To Ref1~4, Wave1~4
 To File DSxxxx.csv, DSxxxx.lsf, CH1~CH4.lsf*
 *(saved to an ALLXXX directory)

6. Press *Save Now* to confirm saving. When completed, a message appears at the bottom of the display.



Note  The file will not be saved if the power is turned Off or the USB drive is taken out before the message ends.

USB file utility To edit USB flash drive contents (create/ delete/ rename files and folders), press *File Utilities*. For details, see page 167.



PC software
(FreeWave)

Saving waveforms can also be accomplished using FreeWave, downloadable from GWInstek website.



Save Setup

Panel operation

1. (For saving to an external USB flash drive) Connect the drive to the front or rear panel USB port.
Note: Only one host connection, front or rear, is allowed at a time.

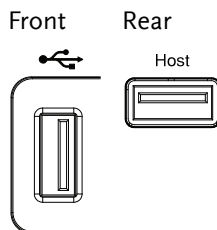

2. Press the *Save/Recall* key from the front panel.
3. Press *Save Setup* from the bottom menu.
4. Press *To* (internal memory) or *To File* and choose a destination to save.



To Set1~Set20
To File DSxxxx.set

5. Press *Save Now* to confirm saving. When completed, a message appears at the bottom of the display.



Setup save to Disk :/DS0001.SET completed!

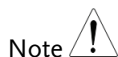

The file will not be saved if the power is turned Off or the USB drive is taken out before the message ends.

USB file utility

To edit USB flash drive contents (create/ delete/ rename files and folders) or to set the file path, press *File Utilities*. For details, see 167.



Edit Label

To edit labels for Setup files, press *Edit Label*. For more details on editing labels, see page 152.



Recall

File Type/Source/Destination

Item	Source	Destination
Default panel setup	<ul style="list-style-type: none"> Factory installed setting 	<ul style="list-style-type: none"> Current front panel setting
Reference waveform	<ul style="list-style-type: none"> Internal memory: Ref1~4 	<ul style="list-style-type: none"> Current front panel
Panel setup (DSxxx.set)	<ul style="list-style-type: none"> Internal memory: S1 ~ S20 File system: Disk, USB 	<ul style="list-style-type: none"> Current front panel
Waveform data (DSxxx.lsf) (CH1~CH4.lsf)*	<ul style="list-style-type: none"> Internal memory: Wave 1 ~ Wave20 File system: Disk, USB 	<ul style="list-style-type: none"> Reference waveform 1 ~ 4

*Recalled from ALLXXX directories.

Recall Default Panel Setting

Panel operation 1. Press the *Default Setup* key.



2. The screen will update with the default panel settings.

Setting contents The following is the default (factory) setting contents.

Acquire	Mode: Sample	XY: OFF
	Sample mode: ET	Delay: On

	Sample rate: 250MSPS	
Display	Mode: Vector Waveform intensity: 50% Waveform visuals: Gray	Persistence: 100ms Graticule intensity: 50% Graticule: full 
Channel	Scale: 100mV/Div Coupling: DC Invert: Off Expand: By ground Probe: voltage Deskew: 0s	CH1: On Impedance: 1MΩ Bandwidth: full Position: 0.00V Probe attenuation: 1x
Cursor	Horizontal cursor: Off	Vertical Cursor: Off
Measure	Source: CH1 Display: Off	Gating: Off
Horizontal	Scale: 10us/Div	
Math	Source1: CH1 Source2: CH2 Unit/Div: 200mV	Operator: + Position: 0.00 Div Math Off
Test	App: Go-NoGo	
Trigger	Type: Edge Coupling: DC Rejection: Off Slope: positive Mode: Auto	Source: CH1 Alternate: Off Noise Rejection: Off Level: 0.00V Holdoff: 10.0ns
Utility	Language: English Print key: Save USB device: Computer	Volume: 60% Ink Saver: Off USB class: CDC
Save recall	Image file format: Bmp	Data file format: LSF

Recall Waveform

- Panel operation
- (For recalling from an external USB flash drive) Connect the drive to the front or rear panel USB port. Note: Only one host connection, front or rear, is allowed at a time.

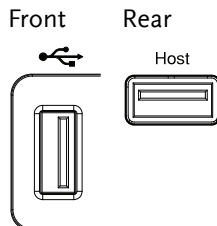

- The waveform must be stored in advance. See page 156 for waveform store details.
- Press the *Save/Recall* key.



- Press *Recall Waveform* from the bottom menu. The Recall menu appears.
- Press *From* (internal memory) or *From File* and choose a source to recall from.



From Wave1~4

From File* DSxxxx.lsf, CH1~CH4.lsf

*Only files in the current file path will be available, this includes files saved in the ALLXXX directories.

- Press *To* and select the reference waveform to recall to.

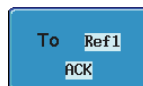

To Ref1~14

7. Press *Recall Now* to recall the waveform.

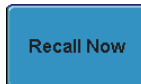

- USB file utility To edit USB flash drive contents (create/ delete/ rename files and folders) or to set the file path, press *File Utilities*. For details, see page 167.



Recall Setup

- Panel operation 1. (For recalling from an external USB flash drive) Connect the drive to the front or rear panel USB port. Note: Only one host connection, front or rear, is allowed at a time.

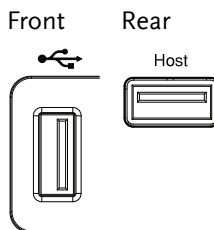

2. Press the *Save/Recall* key.
3. Press *Recall Setup* from the bottom menu.
4. Press *From* (internal memory) or *From File* and choose a source to recall from.



From Set1~20

From File DSxxxx.set (USB, Disk)*

* Only files in the current file path will be available.

5. Press *Recall Now* to confirm recalling. When completed, a message appears at the bottom of the display.

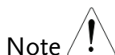
A blue rectangular button with rounded corners and a thin black border, containing the text "Recall Now" in white.An orange rectangular message box with rounded corners and a thin black border, containing the text "Setup recalled from Set1!" in black.

The file will not be saved if the power is turned Off or the USB drive is taken out before the message ends.

USB file utility

To edit USB flash drive contents (create/ delete/ rename files and folders) or to set the file path, press *File Utilities*. For details, see page 167.

A blue rectangular button with rounded corners and a thin black border, containing the text "File Utilities" in white.

Edit Label

To edit labels for Setup files, press *Edit label*. For more details on editing labels, see page 152.

A blue rectangular button with rounded corners and a thin black border, containing the text "Edit Label" in white.

Reference Waveforms

Recall and Display Reference Waveforms

Panel operation A reference waveform must be stored in advance. See page 156 to store waveforms as reference waveforms.

1. Press the *REF* key on the front panel.



2. Pressing *R1~R4* repeatedly will toggle the corresponding reference waveform OFF/ON.

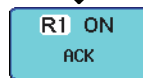

Turning *R1~R4* ON will open the corresponding reference menu.

3. If a reference waveform is ON but not active, its reference menu can be opened by pressing the corresponding *R1~R4* key from the bottom menu.

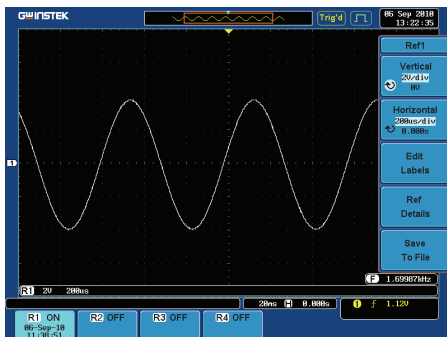
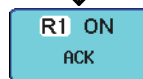
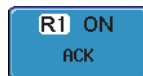

Vertical navigation Press *Vertical* repeatedly from the side menu to choose to edit the vertical position or Volts/Div. Use the Variable knob to edit the values.

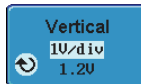

Horizontal navigation Press *Horizontal* repeatedly from the side menu to choose to edit the Time/Div or the horizontal position. Use the Variable knob to edit the value.

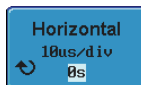

View reference waveform details Pressing *Ref Details* will display the reference waveform details.



Details Sample Rate, Record Length, Date

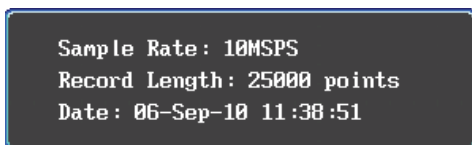

Edit labels To edit labels for Setup files, press *Edit labels*. For more details on editing labels, see page 152.



Save reference waveforms To save reference waveforms, press *Save to File*. For more Details on saving waveforms, see page 148.



FILE UTILITIES

The file utilities are used each time files need to be saved to internal or external memory. The file utilities can create directories, delete directories and rename files. BMP and PNG image files can be previewed in the file system. The File Utilities menu also sets the file path for saving and recalling files from the Save/Recall menu.

File Navigation	170
Create Folder	172
Rename Folder or File.....	173
Delete File	175

File Navigation

The File Utilities menu can be used to choose files or to set the file path for saving/recalling files.

File System

File path

Drive space

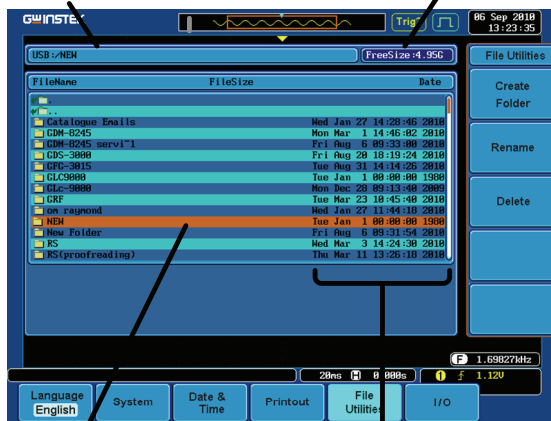

File cursor

File attributes

Panel operation

1. Press the *Utility* key.



2. Press *File Utilities* from the bottom menu.



3. The file system appears.

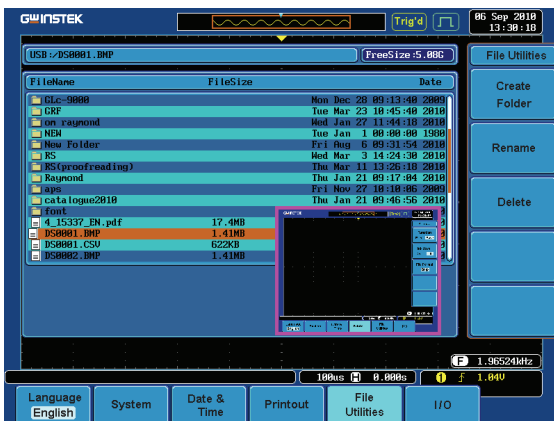

4. Use the *Variable* knob to move the file cursor up and down.



Use the *Select* key to choose a file or directory or to set the file path.

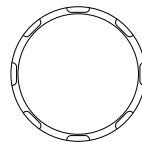

The file path can be set to internal memory or to a directory on a USB memory stick.



Note

Selecting a waveform file will cause that file to be recalled to the currently configured reference waveform.

Create Folder

Panel operation 1. Press the *Utility* key.



2. Press *File Utilities* from the bottom menu.



3. Use the variable knob and select key to navigate the file system.



4. Press *Create Folder* to make a new directory at the selected location.

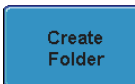

5. Use the *Variable* knob to highlight a character.

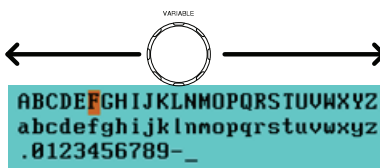

Press *Enter Character* to select a number or letter.

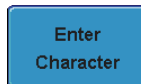

Press *Back Space* to delete a character.



6. Press *Editing completed* to create the folder name.

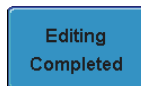

Cancel

Press *Cancel* to cancel the operation.



Rename File

Panel operation

1. Press the Utility key.



2. Press *File Utilities* from the bottom menu.



3. Use the variable knob and select key to choose a file to rename.

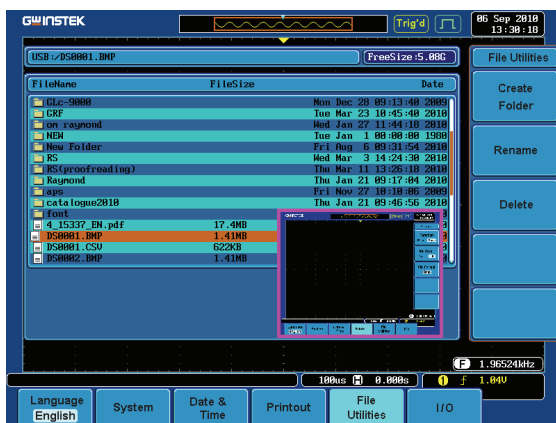

4. Press *Rename* when a file is chosen.

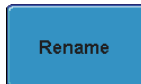

5. Use the *Variable* knob to highlight a character.



Press *Enter Character* select a number or letter.

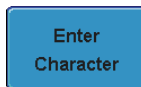

Press *Back Space* to delete a character.



6. Press *Editing completed* to create the folder or file name.

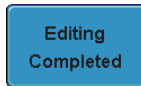

Delete File

Panel operation 1. Press the *Utility* key.



2. Press *File Utilities* from the bottom menu.



3. Use the variable knob and select key to navigate the file system to choose a file.

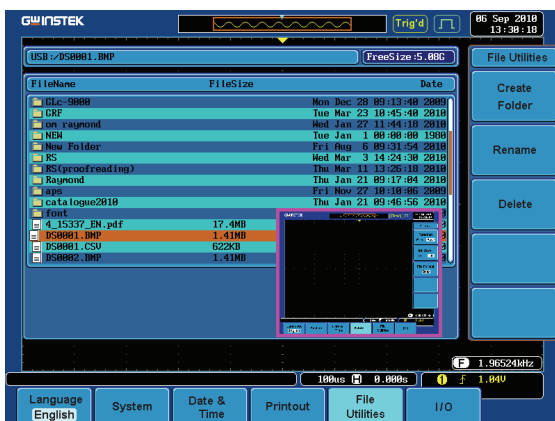

4. Press *Delete* to delete the selected file.

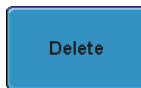

5. Press *Delete* again to confirm the deletion.

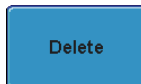

PRINT OUT

Screen images can be printed to any PictBridge compatible printer using the USB device port. The GDS-3000 has a dedicated Print key for quick and easy printing. To reduce the amount of printer ink used for each print, images can be printed using the Ink Saver function.

Screen images can also be printed using the remote control software, FreeWave, downloadable from GWInstek website.

Printer I/O Configuration

Panel Operation 1. Connect a PictBridge printer to the USB device port on the rear panel.

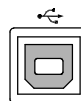

2. Press the *Utility* key.



3. Press *I/O* from the bottom menu.

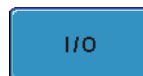

4. Press *USB Device Port* from the side menu and select *Printer*.



Print Output

Ensure the USB port has been configured to the Printer before trying to print, see page 177.

Panel operation

1. Press the *Utility* key.



2. Press *Printout* from the bottom menu.



3. On the side menu, press *Function* repeatedly to select Print.



4. The Print led on the screen bezel will be lit when the printout Function is set to *Print*.

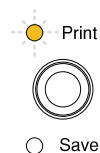

5. Press the Print key located on the screen bezel. The display image is printed out.

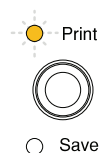

Ink Saver

To have a white background on the saved or printed display image, press *Ink Saver* repeatedly to toggle Ink Saver On or Off from the side menu.



Ink Saver On

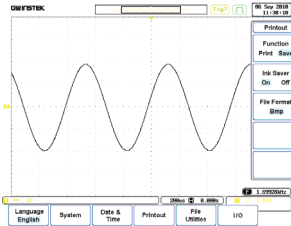

Ink Saver Off

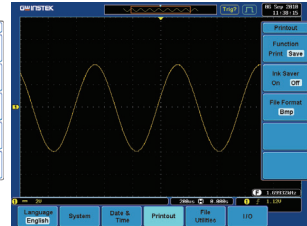

REMOTE CONTROL CONFIG





This chapter describes basic configuration of IEEE488.2 based remote control. For a command list, refer to the programming manual downloadable from GWInstek website, www.gwinstek.com

Interface Configuration	182
Configure USB Interface.....	182
Configure RS-232C Interface	183
Configure the Ethernet Interface.....	184
Configure GPIB Interface	187
USB/RS-232C Remote Control Software	188

Interface Configuration

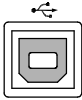

Configure USB Interface

USB configuration	PC side connector	Type A, host
	GDS-3000 side connector	Type B, slave
	Speed	1.1/2.0 (full speed)
	USB Class	CDC (communications device class)

- Panel operation
1. Press the Utility key. 
 2. Press I/O from the bottom menu. 
 3. Press USB Device Port from the side menu and choose Computer. 
 4. Press Computer from the side menu. 
 6. Connect the USB cable to the rear panel slave port. 
 7. When the PC asks for the USB driver, select dso_cdc.inf included in the FreeWave software package downloadable from GW website, www.gwinstek.com, the GDS-3000 product corner. The driver file automatically sets the GDS-3000 as a serial COM port.

Configure RS-232C Interface

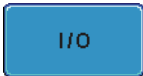
RS-232C configuration	Connector	DB-9, Male
	Baud rate	2400, 4800, 9600, 19200, 38400, 57600, 115200
	Parity	None, Odd, Even
	Data bit	8 (fixed)
	Stop bit	1, 2

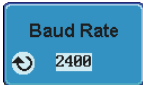
- Panel operation
1. Press the *Utility* key.
 
 2. Press *I/O* from the bottom menu.
 
 3. Press *RS-232C* from the side menu.
 
 4. Use the side menu to set the Baud Rate.
 

Baud Rate 2400, 4800, 9600, 19200, 38400, 57600, 115200
 5. Press *Stop Bit* to toggle the number of stop bits.
 

Stop Bits 1, 2
 6. Press *Parity* to toggle the parity.
 

Parity Odd, Even, None

7. Connect the RS-232C cable to the rear panel port: DB-9 male connector. For a functionality check, see page 188.

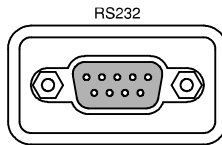

Pin assignment

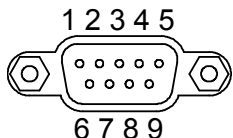

- 2: RxD (Receive data)
- 3: TxD (Transmit data)
- 5: GND
- 4, 6 ~ 9: No connection

PC connection

Use the Null Modem connection as in the below diagram.

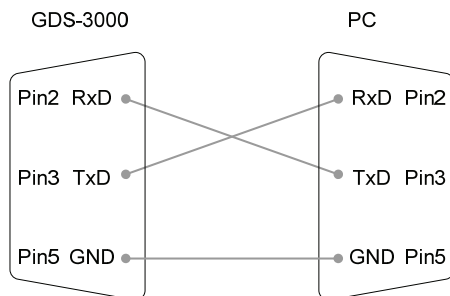

Configure the Ethernet Interface

Ethernet configuration

- MAC Address
- Instrument Name
- User Password
- Instrument IP Address
- Domain Name
- DNS IP Address
- Gateway IP Address
- Subnet Mask
- HTTP Port 80 (fixed)

Background

The Ethernet interface is used for firmware upgrades and remote control over a network.

Panel operation

1. Press the *Utility* key.



2. Press *I/O* from the bottom menu.

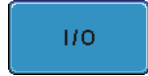

3. Press *Ethernet* from the side menu.



4. Set *DHCP/BOOTP* to *On* or *Off* from the side menu.

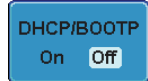

Note

IP addresses will automatically be assigned with DHCP/BOOTP set to on. For Static IP Addresses, DHCP/BOOTP should be set to off.

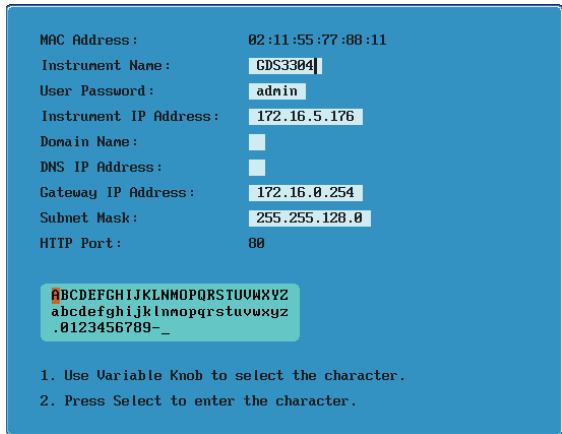

5. Use the *Up* and *Down* arrows on the side menu to navigate each Ethernet configuration item.



Items MAC Address, Instrument Name,
 User Password, Instrument IP
 Address, Domain Name, DNS IP
 Address, Gateway IP Address,
 Subnet Mask

Note: HTTP Port is fixed at 80.

- Use the Variable knob to highlight a character and use the Select key to choose a character.

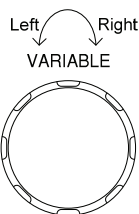

Press *Backspace* to delete a character.



- Connect the Ethernet cable to the rear panel of the GDS-3000.



Configure GPIB Interface

To use GPIB, the optional GPIB to USB (GUG-001) adapter must be used. The GPIB address can be configured for the GUG-001 from the utility menu. See the GUG-001 user manual for more information.

Configure GPIB

1. Insert the GUG-001 USB cable into the rear panel USB device port.



2. Press the *Utility* key.



3. Press *I/O* from the bottom menu.

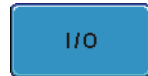

4. Press USB Device Port from the side menu and choose Computer.



5. Press *GPIB* from the side menu.



6. Use the variable knob to set the GPIB Address from the side menu.



Range 1 ~ 30

- GPIB constraints
- Maximum 15 devices altogether, 20m cable length, 2m between each device
 - Unique address assigned to each device
 - At least 2/3 of the devices turned On
 - No loop or parallel connection

USB/RS-232C Remote Control Software

Terminal application (USB/RS-232C) Invoke the terminal application such as MTTY (Multi-Threaded TTY). For RS-232C, set the COM port, baud rate, stop bit, data bit, and parity accordingly.

To check the COM port No, see the Device Manager in the PC. For WinXP, Control panel → System → Hardware tab.

Functionality check Run this query command via the terminal.

*idn?

This should return the Manufacturer, Model number, Serial number, and Firmware version in the following format.

GW, GDS-3152, 000000001, V1.00

PC Software (USB only) The proprietary PC software FreeWave is downloadable from the GWInstek website for remote control.

M AINTENANCE

Two types of maintenance operations are available: calibrate vertical resolution, and compensate the probe. Run these operations when using the GDS-3000 in a new environment.

Vertical Resolution Calibration	190
Probe Compensation	191
Activating Optional Software	193

Vertical Resolution Calibration

Panel operation 1. Press the *Utility* key.



2. Press *System* from the bottom menu.

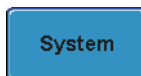

3. Press *NEXT* from the side menu.



4. Press *Self Cal* on the side menu.



5. A message appears to "Set CAL to CH1, then press Self Cal".

6. Connect the calibration signal from the rear panel to the Channel1 input with a BNC cable.

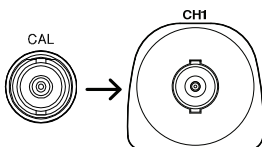

7. Press *Self Cal* again after connecting CAL to the channel 1 input.



The calibration for Channel1 starts and ends automatically, in less than 5 minutes. A message is displayed when the calibration procedure has ended.

8. Repeat the above step for Channel 2, 3* and 4* when prompted.
 *4 channel models.
9. When the calibration for all channels has completed, the display goes back to the default state.

Probe Compensation

- Panel operation
1. Connect the probe between the Channel1 input and the probe compensation output (2Vp-p, 1kHz square wave) on the front panel. Set the probe attenuation to x10 (GDP probes are fixed at x10).

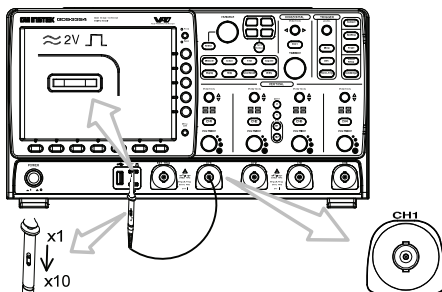

2. Press the *CH1* key to activate CH1.



3. Set the *Coupling* to DC from the bottom menu.

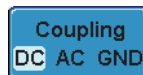

4. Set *Impedance* to 1MΩ from the bottom menu.

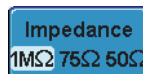

5. Set the Probe attenuation to *Voltage, 10X*. Page 124

6. Press the *Autoset* key. The compensation signal appears on the display.



7. Press the *Display* key, then set the display type to *Vector*.

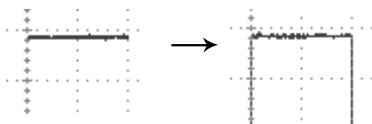
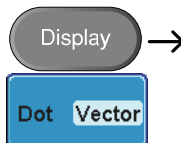

8. Turn the adjustment point on the probe until the signal edge becomes sharp.

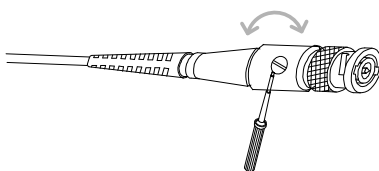
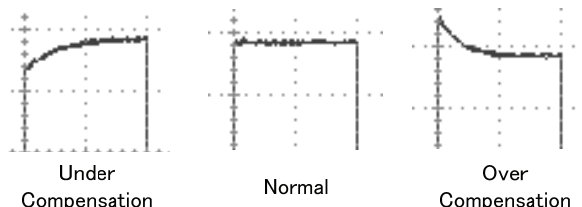

Activating Optional Software

Background The GDS-3000 has Power Analysis software (page 95) and Serial bus decoding software (page 95) as optional extras. An activation key is required to activate the software. An activation key is required for each optional software package.

If the optional software packages have not been purchased, a time trial demonstration is available for a 1 month period. Before activating the time trial demonstration, ensure the date and time has been set. Changing the system date will not have an effect on the time trial period. The time trial demonstration software can only be used once.

For the latest files and information regarding the optional software packages, see the GW Instek website: www.gwinstek.com

Activation key filenames	Power analysis activation keys	PowerEnableTrial.LIS PowerEnable.LIS
	Serial bus decode activation keys	BusEnableTrial.LIS BusEnable.LIS

Step 1. Ensure the date and time has been set. Page 145

2. Insert a USB stick into front panel USB port with the activation keys located in the root directory.

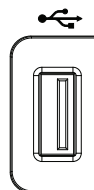

3. Press the *Utility* key.



4. Press *File Utilities* from the bottom menu.



5. The file system appears.

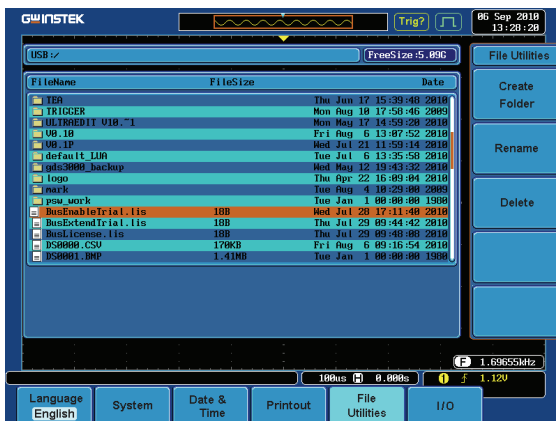

6. Use the Variable knob and Select key to select the activation key from the USB root directory. When prompted to continue, press the *Select* key again.

Files: PowerEnableTrial.LIS
 PowerEnable.LIS
 BusEnableTrial.LIS
 BusEnable.LIS

Confirm
Activation key

Press the *Test* key on the front panel and *Power Analysis* from the bottom menu to see if the Power Analysis activation worked.

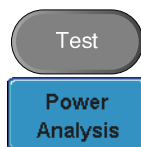

Press *B1* on the front panel to see if the Serial Bus decode activation worked.



F AQ

- I connected the signal but it does not appear on the display.
- I want to remove the (Measurement result / FFT result / Help contents) from the display.
- The waveform does not update (frozen).
- The probe waveform is distorted.
- Autoset does not catch the signal well.
- I can't save files to the internal memory.
- The display image printout is too dark on the background.
- The date and time setting are not correct.
- USB does not work.
- The accuracy does not match the specification.

I connected the signal but it does not appear on the display.

Make sure you have activated the channel by pressing the Channel key (the channel key lights up).

I want to remove the (Measurement result / FFT result / Help contents) from the display.

To clear automatic measurement results, press the Measure key, Select Remove Measurement and choose Remove All. See page 73.

To clear individual measurements from the screen, press the Measure key, select Display All and choose Display None. See page 75.

To clear FFT result, press the Math key twice. See page 83 for details.

To clear Help result, press the Help key again. See page 55 for details.

The waveform does not update (frozen).

Press the Run/Stop key to unfreeze the waveform. See page 62 for details.

If this does not help, the trigger mode might be set to Single. Press the Single key to exit Single mode. See page 62 for trigger setting details.

The probe waveform is distorted.

You might need to compensate the probe. The input impedance may also have to be changed to suit your probe. For details, see page 191. Note that the frequency accuracy and duty factor are not specified for the probe compensation waveform and therefore it should not be used for other reference purposes. Also remember to set the impedance to $1M\Omega$.

Autoset does not catch the signal well.

The Autoset function cannot catch signals under 30mV or 20Hz. Please use the manual operation. See page 61 for Autoset details.

I can't save files to the internal memory.

If a USB stick is inserted into one of the USB slots and you wish to save to the scope internal memory, press the *Utilities* key and set the file path to internal memory. When a USB stick is inserted into any of the USB slots, the file path is automatically set to the USB root directory.

The display image printout is too dark on the background.

Use the Ink Saver function which reverses the background color. For details, see page 177.

The date and time setting are not correct.

For date and time setting details, please see page 145. If it does not help, the internal battery controlling the clock might be worn out. Contact your dealer or GWInstek.

USB does not work.

Make sure you are not using the front and the rear USB host connector at the same time. Disconnect either of the USB devices and try again.

The accuracy does not match the specification.

Make sure the device is powered On for at least 30 minutes, within +20°C~+30°C. This is necessary to stabilize the unit to match the specification.

For more information, contact your local dealer or GWInstek at www.gwinstek.com / marketing@goodwill.com.tw.

A PPENDIX

GDS-3000 Specifications

The specifications apply when the GDS-3000 is powered on for at least 30 minutes under +20°C~+30°C.

Model-specific

GDS-3152	Channels	2 + Ext
	Bandwidth	DC ~ 150MHz (-3dB)
	Rise time	2.3ns
GDS-3154	Channels	4 + Ext
	Bandwidth	DC ~ 150MHz (-3dB)
	Rise time	2.3ns
GDS-3252	Channels	2 + Ext
	Bandwidth	DC ~ 250MHz (-3dB)
	Rise time	1.4ns
GDS-3254	Channels	4 + Ext
	Bandwidth	DC ~ 250MHz (-3dB)
	Rise time	1.4ns
GDS-3352	Channels	2 + Ext
	Bandwidth	DC ~ 350MHz (-3dB)
	Rise time	1ns
GDS-3354	Channels	4 + Ext
	Bandwidth	DC ~ 350MHz (-3dB)
	Rise time	1ns

The bandwidth of the 75Ω input impedance is limited to 150MHz only.

Common

Vertical	Resolution	8 bit @1MΩ: 2mV~5V @50/75MΩ: 2mV~1V
	Input Coupling	AC, DC, GND
	Input Impedance	1MΩ// 15pF
	DC Gain	±(3% X Readout + 0.1div + 1mV)
	Accuracy	
	Polarity	Normal & Invert
	Maximum	@1 MΩ: 300V (DC+AC Peak), CAT I
	Input Voltage	@50/75Ω: 5 VRMS max
	Offset Position	2mV/div ~ 100mV/div : ±0.5V
	Range	200mV/div ~ 5V/div : ±25V
	Bandwidth Limit	Dependent on the oscilloscope bandwidth (BW. BW=150: Full, 20MHz BW=250: Full, 20MHz, 100MHz BW=350: Full, 20MHz, 100MHz, 200MHz
	Waveform Signal Process	Add, subtract, multiply, and divide waveforms, FFT, FFTrms FFT:Spectral magnitude. Set FFT Vertical Scale to Linear RMS or dBV RMS, and FFT Window to Rectangular, Hamming, Hanning, or Blackman-Harris.
	Trigger	Sources
Modes		Auto (supports Roll Mode for 100 ms/div and slower), Normal, Single
Type		Edge, Pulse Width, Video, Pulse Runt, Rise & Fall, Alternate, Event-Delay(1~65535 events), Time-Delay(10nS~10S), I ² C*, SPI*, UART* *optional Runt:Trigger on a pulse that crosses one threshold but fails to cross a second threshold before crossing the first again. SPI (optional):Trigger on SS, MOSI, MISO, or MOSI and MISO on SPI buses. I ² C (optional):Trigger on Start, Repeated Start, Stop, Missing ACK, Address (7 or 10 bit), Data, or Address and Data on I ² C buses. UART (optional): Trigger on Tx Start Bit, Rx Start Bit, Tx End of Packet, Rx End of Packet, Tx Data, Rx Data, Tx Parity Error, and Rx Parity.

	Holdoff range	10nS to 10S
	Coupling	AC,DC,LF rej. ,Hf rej. ,Noise rej.
	Sensitivity	DC ~ 50MHz Approx. 1div or 1.0mV 50MHz ~ 150MHz Approx. 1.5div or 15mV 150MHz ~ 350MHz Approx. 2div or 20mV
External Trigger	Range	±15V
	Sensitivity	DC ~ 50MHz Approx. 1div~10mV 150MHz ~ 250MHz Approx. 150mV 250MHz ~ 350MHz Approx. 150mV
	Input Impedance	1MΩ//15pF
Horizontal	Range	1ns/div ~ 100s/div (1-2-5 increments); ROLL : 100ms/div ~ 100s/div
	Pre-trigger	10 div maximum
	Post-trigger	1000 div
	Accuracy	±20 ppm over any ≥1 ms time interval
X-Y Mode	X-Axis Input	Channel 1;Channel 3
	Y-Axis Input	Channel 2;Channel 4
	Phase Shift	±3° at 100kHz
Signal Acquisition	Real Time	5GSa/s (MAX)
	Sample Rate	150 & 250MHz 2CH: 2.5GSa/s
	ET Sample Rate	100GSa/s maximum for all models
	Record Length	25k points
	Acquisition Mode	Normal, Average, Peak Detect, High Resolution, Single
	Peak Detection	2nS (MAX)
		Normal:Acquire sampled values. Average:From2 to 256 waveforms included in average. Peak Detect:Captures glitches as narrow as 2 ns at all sweep speeds Hi Res:Real-time boxcar averaging reduces random noise.
Cursors and Measurement	Cursors	Amplitude, Time, Gating available
	Automatic Measurement	28 sets: Vpp , Vamp , Vavg , Vrms , Vhi , Vlo , Vmax , Vmin , Rise Preshoot/ Overshoot , Fall Preshoot/Overshoot, Freq , Period , Rise Time , Fall Time , Positive Width , Negative Width , Duty Cycle, Phase, and eight different delay measurements (FRR,FRF,FFR,FFF,LRR,LRF,LFR,LFF)
	Cursors measurement	Voltage difference between cursors (ΔV) Time difference between cursors (ΔT)

	Auto counter	6 digits, range from 2Hz minimum to the rated bandwidth
Power Measurements (Option)	Power Quality Measurements	VRMS, V Crest Factor, Frequency, IRMS, I Crest Factor, True Power, Apparent Power, Reactive Power, Power Factor, Phase Angle.
	Harmonics	Freq, Mag, Mag rms, Phase, THD-F, THD-R, RMS
	Ripple Measurements	V, I
	In-rush current	First peak, second peak
Control Panel Function	Autoset	Single-button, automatic setup of all channels for vertical, horizontal and trigger systems, with undo autoset
	Auto-Range	allow users to quickly move from test point to test point without having to reset the oscilloscope for each test point
	Save Setup	20set
	Save Waveform	24set
Display	TFT LCD Type	8" TFT LCD SVGA color display
	Display Resolution	800 horizontal × 600 vertical pixels (SVGA)
	Interpolation	Sin(x)/x & Equivalent Time Sampling
	Waveform Display	Dots, vectors, variable persistence, infinite persistence
	Display Graticule	8 x 10 divisions
	Display Brightness	Adjustable
Interface	RS232C	DB-9 male connector
	USB Port	2 sets USB 2.0 High-speed host port ;1 set USB High-speed 2.0 device port
	Ethernet Port	RJ-45 connector, 10/100Mbps
	SVGA Video Port	DB-15 female connector, monitor output for display on SVGA monitors
	GPIB	USB-to-GPIB converter (Option)
	Go-NoGo BNC	5V Max/10mA TTL Open collector output
	Internal flash disk	64MB
	Kensington Style Lock	Rear-panel security slot connects to standard Kensington-style lock.
	Line output	Go/NoGo audio alarm
	Trigger out BNC	5V TTL output

Power Source	Line Voltage Range	AC 100V ~ 240V , 47Hz ~ 63Hz , Auto selection
	Power Consumption	96VA
Miscellaneous	Multi-language menu	Available
	On-line help	Available
	Time clock	Time and Data ,Provide the Data/Time for saved data
Dimensions	400W X 200H X 130D, Approx. 4kg	

Probe Specifications

Model-specific

GTP-151R	Applicable to Bandwidth Rise time Input Capacitance	GDS-3152 / GDS-3154 DC ~ 150MHz 2.3ns ~12pF
GTP-251R	Applicable to Bandwidth Rise time Input Capacitance	GDS-3252 / GDS-3254 DC ~ 250MHz 1.4ns ~12pF
GTP-351R	Applicable to Bandwidth Rise time Input Capacitance	GDS-3352 / GDS-3354 DC ~ 350MHz 1.4ns ~12pF

Common

Position x 10	Attenuation Ratio	10:1 (fixed) with readout pin
	Input Resistance	10MΩ when used with 1MΩ input oscilloscope
	Compensation Range	10 ~ 30pF
	Maximum Input Voltage	500V CAT I, 300V CAT II (DC+Peak AC) Derating with frequency
Operating Condition	Temperature	-0°C ~ 50°C
	Relative Humidity	≤85% @35°C
Safety Standard	EN61010-031 CAT II	

GDS-3000 Dimensions

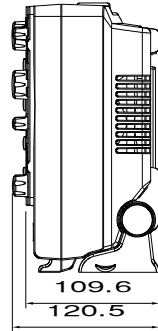
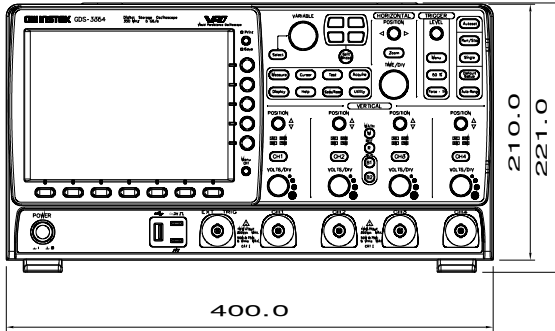
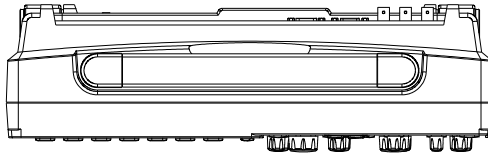

Declaration of Conformity

We

GOOD WILL INSTRUMENT CO., LTD.

No. 7-1, Jhongsing Rd, Tucheng City, Taipei County 236. Taiwan.

GOOD WILL INSTRUMENT (SUZHOU) CO., LTD.

No. 69 Lushan Road, Suzhou New District Jiangsu, China.

declare that the below mentioned product

Type of Product: **Digital Storage Oscilloscope**

Model Number: **GDS-3152, GDS-3252, GDS-3352, GDS-3154, GDS-3254, GDS-3354**

are herewith confirmed to comply with the requirements set out in the Council Directive on the Approximation of the Law of Member States relating to Electromagnetic Compatibility (2004/108/EEC) and Low Voltage Directive (2006/95/EEC).

For the evaluation regarding the Electromagnetic Compatibility and Low Voltage Directive, the following standards were applied:

© EMC	
EN 61326-1: EN 61326-2-1	Electrical equipment for measurement, control and laboratory use -- EMC requirements (2006)
Conducted & Radiated Emission EN 55011: 2007+A2: 2007	Electrostatic Discharge EN 61000-4-2: 2009
Current Harmonics EN 61000-3-2: 2006+A1: 2009+A2: 2009	Radiated Immunity EN 61000-4-3: 2006+A1: 2008
Voltage Fluctuations EN 61000-3-3: 2008	Electrical Fast Transients IEC 61000-4-4: 2004+Corr.1: 2006 +Corr2: 2007
-----	Surge Immunity EN 61000-4-5: 2006
-----	Conducted Susceptibility EN 61000-4-6: 2009
-----	Power Frequency Magnetic Field EN 61000-4-8: 1993+A1: 2001
-----	Voltage Dip/ Interruption EN 61000-4-11: 2004

Low Voltage Equipment Directive 2006/95/EEC	
Safety Requirements	IEC/EN 61010-1: 2001

I NDEX

- 2-4 channel differences..... 12
- AC coupling 120
- Acquisition 101
 - indicator 26
 - Sampling mode..... 105
 - specification..... 201
 - XY mode..... 103
- Activation keys 193
- APP.
 - Go-NoGo..... 90
 - overview 88
 - run..... 88
- Auto trigger..... 128
- Automatic measurement
 - display all..... 75
 - gated display mode..... 74
 - individual mode 72
 - overview 69
 - remove measurement 73
- Auto-range..... 62
 - exception..... 63
- Autoset..... 61
 - effect on channel..... 60
 - exception..... 61
- Average voltage measure 70
- Bandwidth filter 122
- Blackman window 84
- Built-in help..... 55
- Buzzer 145
- Calibration, vertical resolution190
- Caution symbol..... 5
- Channel 59
 - status indicator 27
- Cleaning the instrument 8
- Control panel function
 - specification..... 202
- Convention
 - menu tree 39
- Conventions.....33
- Coupling mode..... 120
- Cursor
 - horizontal..... 77
 - specification..... 201
 - vertical..... 80
- Cycle time measure.....70
- Date setting 145
 - indicator..... 26
- DC coupling..... 120
- Declaration of conformity 206
- Default setup 161
 - contents 53, 150, 161
 - effect on channel..... 60
- Delay measure.....71
- Delay trigger..... 135
- Deskew 125
- Dimensions
 - diagram 205
 - specification..... 203
- Display
 - diagram 25
 - specification..... 202
- Disposal instructions 8
- Dots..... 108
- Download information..... 16
- Duty cycle measure 70
- Edge Trigger 133
- EN61010
 - measurement category 7
 - pollution degree 8
- Environment
 - safety instruction..... 8
- Equivalent time sampling 106
- Erase memory..... 144
- Ethernet
 - interface..... 184
- Expand by ground/center 123

External trigger	128	Invert waveform	121
input terminal	22	Keys overview	18
specification	201	Labels	152
Falling time measure	70	Language selection	143
FAQ	195	List of features	13
FFT	86	Logic trigger	141
horizontal cursor	78	Low voltage measure	70
Overview	83	Marketing	
vertical cursor	81	contact	197
File		Math	83
create folder	172	basic	84
delete	175	FFT	86
rename	173	Memory bar	
File navigation	170	indicator	26
File path	171	Menu on/off	113
Firmware version	144	Miscellaneous	
First time use	30	specification	203
Frequency measure	70	Model difference	12
Front panel diagram	17	Normal trigger	128
Go-NoGo	90	NTSC	130
circuit diagram	94	On-screen help	55
timing	93	Optional software	
GPIB		activation	193
interface	187	Overshoot voltage measure	70
Ground		Package contents	16
coupling	120	PAL	130
symbol	5	Pc software download	16
terminal	22	PC software download	188
Hamming window	84	Peak voltage measure	69
Hanning window	83	Persistence	109
High voltage measure	70	Power Analysis	95
Holdoff	102, 132	overview	95
Horizontal		Power measurements	
basic operation	64	specification	202
position	114	Power on/off	
scale	115	safety instruction	7
specification	201	Power source	
Image file format	148	specification	203
Impedance	121	Preshoot voltage measure	70
Initialization	30	Printing	
Input frequency indicator	26	connection	177
Intensity	109	ink saver	179
color	111	print key	178
gray	111	Printing	177
Interface	182	Probe	
specification	202	attenuation level	124

- attenuation type..... 124
- deskew 125
- package list..... 16
- specification..... 204
- Probe compensation..... 191
- Program manual download 16
- Pulse runt trigger..... 139
- Pulse time measure..... 70
- Pulse width trigger..... 136
- Real time sampling..... 106
- Rear panel diagram 23
- Recall 161
 - default setup..... 161
 - reference..... 166
 - setup 163, 164
 - waveform..... 163
- Rectangular window 84
- Reduce menu..... 35
- Remote control..... 181
 - interface configuration 182
- Rising time measure 70
- Roll mode..... 116
- RS-232C
 - interface..... 183
- Run/stop 63
- Run/Stop..... 113
 - horizontal position 114
 - Horizontal scale..... 115
- Save..... 154
 - image 155
 - print key 156
 - setup 159
 - waveform..... 157
- SECAM..... 130
- Serial Bus 96
 - overview 96
- Serial number 144
- Service operation
 - about disassembly..... 7
 - contact 197
- Setup
 - default contents 53
 - file format 150
- Single trigger mode 128
 - with run/stop 64
- Software activation..... 193
- Specifications..... 199
- Split Window
 - operation..... 67
 - reference position..... 68
- Spreadsheet file format 149
- Stop icon..... 63
- System information..... 143
- Tilt stand 28
- Time setting 145
 - indicator..... 26
- Trigger..... 126
 - delay 135
 - edge..... 133
 - holdoff..... 132
 - indicator..... 26
 - Logic 141
 - mode..... 133
 - parameters..... 128
 - pulse runt..... 139
 - pulse width..... 136
 - single trigger with run/stop..... 64
 - specification..... 200
 - status indicator 27
 - video..... 138
- UK power cord..... 9
- USB
 - driver download..... 16
 - remote control interface 182
- Vectors..... 108
- Vertical 119
 - basic operation..... 66
 - position..... 119
 - resolution calibration..... 190
 - scale 119
 - specification..... 200
- Video trigger..... 138
- Warning symbol..... 5
- Waveform
 - data contents 149
 - file contents 149
 - how to recall..... 163
 - how to save..... 157
 - invert waveform 121
 - roll mode..... 116
 - zoom mode..... 117
- Waveform color..... 25
- Waveform file format 148
- XY
 - specification..... 201

Zoom waveform 117